

---

# CSIT REPORT

*Release rls1901*

Feb 14, 2019

---

# Contents

---

<b>1</b>	<b>Introduction</b>	<b>1</b>
1.1	Report History . . . . .	1
1.2	Report Structure . . . . .	1
1.3	Test Scenarios . . . . .	3
1.4	Physical Testbeds . . . . .	4
1.5	Test Methodology . . . . .	11
<b>2</b>	<b>VPP Performance</b>	<b>31</b>
2.1	Overview . . . . .	31
2.2	Release Notes . . . . .	38
2.3	Packet Throughput . . . . .	40
2.4	Speedup Multi-Core . . . . .	339
2.5	Packet Latency . . . . .	488
2.6	Soak Tests . . . . .	634
2.7	NFV Service Density . . . . .	636
2.8	Comparisons . . . . .	676
2.9	Throughput Trending . . . . .	682
2.10	Test Environment . . . . .	683
2.11	Documentation . . . . .	706
<b>3</b>	<b>DPDK Performance</b>	<b>714</b>
3.1	Overview . . . . .	714
3.2	Release Notes . . . . .	716
3.3	Packet Throughput . . . . .	717
3.4	Packet Latency . . . . .	775
3.5	Comparisons . . . . .	806
3.6	Throughput Trending . . . . .	808
3.7	Test Environment . . . . .	809
3.8	Documentation . . . . .	824
<b>4</b>	<b>VPP Device</b>	<b>825</b>
4.1	Overview . . . . .	825
4.2	Release Notes . . . . .	828
4.3	Integration Tests . . . . .	829
4.4	Documentation . . . . .	837
<b>5</b>	<b>VPP Functional</b>	<b>838</b>
5.1	Overview . . . . .	838
5.2	Release Notes . . . . .	841
5.3	Test Environment . . . . .	842
5.4	Documentation . . . . .	852

<b>6</b>	<b>HoneyComb Functional</b>	<b>853</b>
6.1	Overview . . . . .	853
6.2	Release Notes . . . . .	856
6.3	Test Environment . . . . .	856
6.4	Documentation . . . . .	857
<b>7</b>	<b>DMM Functional</b>	<b>858</b>
7.1	Overview . . . . .	858
7.2	Release Notes . . . . .	859
7.3	Test Environment . . . . .	859
7.4	Documentation . . . . .	859
<b>8</b>	<b>CSIT Framework</b>	<b>860</b>
8.1	Design . . . . .	860
8.2	Test Naming . . . . .	864
8.3	Presentation and Analytics . . . . .	866
8.4	CSIT RF Tags Descriptions . . . . .	893
	<b>Bibliography</b>	<b>907</b>

### 1.1 Report History

FD.io CSIT-1901 Report history and per .[ww] revision changes are listed below.

.[ww] Revision	Changes
.07	Initial version

FD.io CSIT Reports follow CSIT-[yy][mm].[ww] numbering format, with version denoted by concatenation of two digit year [yy] and two digit month [mm], and maintenance revision identified by two digit calendar week number [ww].

### 1.2 Report Structure

FD.io CSIT-1901 report contains system performance and functional testing data of VPP-19.01 release. [PDF version of this report<sup>1</sup>](#) is available for download.

CSIT-1901 report is structured as follows:

1. INTRODUCTION: General introduction to FD.io CSIT-1901.
  - **Introduction:** This section.
  - **Test Scenarios Overview:** A brief overview of test scenarios covered in this report.
  - **Physical Testbeds:** Description of physical testbeds.
  - **Test Methodology:** Performance benchmarking and functional test methodologies.
2. VPP PERFORMANCE: VPP performance tests executed in physical FD.io testbeds.
  - **Overview:** Tested logical topologies, test coverage and naming specifics.
  - **Release Notes:** Changes in CSIT-1901, added tests, environment or methodology changes, known issues.
  - **Packet Throughput:** NDR, PDR throughput graphs based on results from repeated same test job executions to verify repeatability of measurements.

---

<sup>1</sup> [https://docs.fd.io/csit/rls1901/report/\\_static/archive/csit\\_rls1901.07.pdf](https://docs.fd.io/csit/rls1901/report/_static/archive/csit_rls1901.07.pdf)

- **Speedup Multi-Core:** NDR, PDR throughput multi-core speedup graphs based on results from test job executions.
  - **Packet Latency:** Latency graphs based on results from test job executions.
  - **Soak Tests:** Long duration soak tests are executed using PLRsearch algorithm.
  - **NFV Service Density:** Network Function Virtualization (NFV) service density tests focus on measuring total per server throughput at varied NFV service “packing” densities with vswitch providing host dataplane.
  - **HTTP/TCP Performance:** HTTP/TCP VPP test server performance graphs.
  - **Comparisons:** Performance comparisons between VPP releases and between different testbed types.
  - **Throughput Trending:** References to continuous VPP performance trending.
  - **Test Environment:** Performance test environment configuration.
  - **Documentation:** Documentation of K8s Pod/Container orchestration in CSIT and pointers to CSIT source code documentation for VPP performance tests.
3. DPDK PERFORMANCE: DPDK performance tests executed in physical FD.io testbeds.
- **Overview:** Tested logical topologies, test coverage.
  - **Release Notes:** Changes in CSIT-1901, known issues.
  - **Packet Throughput:** NDR, PDR throughput graphs based on results from repeated same test job executions to verify repeatability of measurements.
  - **Packet Latency:** Latency graphs based on results from test job executions.
  - **Comparisons:** Performance comparisons between DPDK releases and between different testbed types.
  - **Throughput Trending:** References to regular DPDK performance trending.
  - **Test Environment:** Performance test environment configuration.
  - **Documentation:** Pointers to CSIT source code documentation for DPDK performance tests.
4. VPP DEVICE: VPP functional tests executed in physical FD.io testbeds using containers.
- **Overview:** Tested virtual topologies, test coverage and naming specifics;
  - **Release Notes:** Changes in CSIT-1901, added tests, environment or methodology changes, known issues.
  - **Integration Tests:** Functional test environment configuration.
  - **Documentation:** Pointers to CSIT source code documentation for VPP functional tests.
5. VPP FUNCTIONAL: VPP functional tests executed in virtual FD.io testbeds.
- **Overview:** Tested virtual topologies, test coverage and naming specifics;
  - **Release Notes:** Changes in CSIT-1901, added tests, environment or methodology changes, known issues.
  - **Test Environment:** Functional test environment configuration.
  - **Documentation:** Pointers to CSIT source code documentation for VPP functional tests.
6. HONEYCOMB FUNCTIONAL: Honeycomb functional tests executed in virtual FD.io testbeds.
- **Overview:** Tested virtual topologies, test coverage and naming specifics;
  - **Release Notes:** Changes in CSIT-1901, known issues.
  - **Test Environment:** Functional test environment configuration.
  - **Documentation:** Pointers to CSIT source code documentation for Honeycomb functional tests.

1. DMM FUNCTIONAL: DMM functional tests executed in virtual FD.io testbeds.
  - **Overview:** Tested virtual topologies, test coverage and naming specifics;
  - **Release Notes:** Changes in CSIT-1901, known issues.
  - **Test Environment:** Functional test environment configuration.
  - **Documentation:** Pointers to CSIT source code documentation for DMM functional tests.
2. DETAILED RESULTS: Detailed result tables auto-generated from CSIT test job executions using RF (Robot Framework) output files as sources.
  - **VPP Performance NDR/PDR:** VPP NDR/PDR throughput and latency.
  - **VPP Performance MRR:** VPP MRR throughput.
  - **VPP K8s Container Memif:** VPP K8s Container/Pod topologies NDR/PDR throughput.
  - **DPDK Performance:** DPDK Testpmd and L3fwd NDR/PDR throughput and latency.
  - **VPP Functional:** Detailed VPP functional results.
  - **Honeycomb Functional:** Detailed HoneyComb functional results.
  - **NSH\_SFC Functional:** Detailed nsh-plugin functional results.
  - **DMM Functional:** Detailed DMM functional results.
3. TEST CONFIGURATION: VPP DUT configuration data based on VPP API Test (VAT) Commands History auto-generated from CSIT test job executions using RF output files as sources.
  - **VPP Performance NDR/PDR:** Configuration data.
  - **VPP Performance MRR:** Configuration data.
  - **VPP K8s Container Memif:** Configuration data.
  - **VPP Functional:** Configuration data.
4. TEST OPERATIONAL DATA: VPP DUT operational data auto-generated from CSIT test job executions using RFoutput files as sources.
  - **VPP Performance NDR/PDR:** VPP *show run* outputs under test load.
5. CSIT FRAMEWORK DOCUMENTATION: Description of the overall FD.io CSIT framework.
  - **Design:** Framework modular design hierarchy.
  - **Test naming:** Test naming convention.
  - **Presentation and Analytics Layer:** Description of PAL CSIT analytics module.
  - **CSIT RF Tags Descriptions:** CSIT RF Tags used for test suite and test case grouping and selection.

## 1.3 Test Scenarios

FD.io CSIT-1901 report includes multiple test scenarios of VPP centric applications, topologies and use cases. In addition it also covers baseline tests of DPDK sample applications. Tests are executed in physical (performance tests) and virtual environments (functional tests).

Brief overview of test scenarios covered in this report:

1. **VPP Performance:** VPP performance tests are executed in physical FD.io testbeds, focusing on VPP network data plane performance in NIC-to-NIC switching topologies. Tested across Intel Xeon Haswell and Skylake servers, range of NICs (10GE, 25GE, 40GE) and multi-thread/multi-core configurations. VPP application runs in bare-metal host user-mode handling NICs. TRex is used as a traffic generator.

2. **VPP Vhostuser Performance with KVM VMs:** VPP VM service switching performance tests using vhostuser virtual interface for interconnecting multiple Testpmd-in-VM instances. VPP vswitch instance runs in bare-metal user-mode handling NICs and connecting over vhost-user interfaces to VM instances each running DPDK Testpmd with virtio virtual interfaces. Similarly to VPP Performance, tests are run across a range of configurations. TRex is used as a traffic generator.
3. **VPP Memif Performance with LXC and Docker Containers:** VPP Container service switching performance tests using memif virtual interface for interconnecting multiple VPP-in-container instances. VPP vswitch instance runs in bare-metal user-mode handling NICs and connecting over memif (Slave side) interfaces to more instances of VPP running in LXC or in Docker Containers, both with memif interfaces (Master side). Similarly to VPP Performance, tests are run across a range of configurations. TRex is used as a traffic generator.
4. **K8s Container/Pod Topologies Performance:** VPP container performance tests using memif for interconnecting VPP-in- Container/Pod instances orchestrated by K8s integrated with [Ligato](#)<sup>2</sup> for container networking. TRex is used as a traffic generator.
5. **DPDK Performance:** VPP uses DPDK to drive the NICs and physical interfaces. DPDK performance tests are used as a baseline to profile performance of the DPDK sub-system. Two DPDK applications are tested: Testpmd and L3fwd. DPDK tests are executed in the same testing environment as VPP tests. DPDK Testpmd and L3fwd applications run in host user-mode. TRex is used as a traffic generator.
6. **VPP Functional:** VPP functional tests are executed in virtual FD.io testbeds, focusing on VPP packet processing functionality, including both network data plane and in-line control plane. Tests cover vNIC-to-vNIC vNIC-to-nestedVM-to-vNIC forwarding topologies. Scapy is used as a traffic generator.
7. **Honeycomb Functional:** Honeycomb functional tests are executed in virtual FD.io testbeds, focusing on Honeycomb management and programming functionality of VPP. Tests cover a range of CRUD operations executed against VPP.
8. **NSH\_SFC Functional:** NSH\_SFC functional tests are executed in virtual FD.io testbeds focusing on VPP nsh-plugin data plane functionality. Scapy is used as a traffic generator.
9. **DMM Functional:** DMM functional tests are executed in virtual FD.io testbeds demonstrating a single server (DUT1) and single client (DUT2) scenario using DMM framework and Linux kernel TCP/IP stack.

All CSIT test data included in this report is auto-generated from RF (Robot Framework) output .xml files produced by LF (Linux Foundation) FD.io Jenkins jobs executed against VPP-19.01 release artifacts. References are provided to the original FD.io Jenkins job results and all archived source files.

FD.io CSIT system is developed using two main coding platforms: RF and Python2.7. CSIT-1901 source code for the executed test suites is available in CSIT branch rls1901 in the directory `./tests/<name_of_the_test_suite>`. A local copy of CSIT source code can be obtained by cloning CSIT git repository - `git clone https://gerrit.fd.io/r/csit`.

## 1.4 Physical Testbeds

All FD.io (Fast Data Input/Output) CSIT (Continuous System Integration and Testing) performance testing listed in this report are executed on physical testbeds built with bare-metal servers hosted by LF FD.io project. Two testbed topologies are used:

- **3-Node Topology:** Consisting of two servers acting as SUTs (Systems Under Test) and one server as TG (Traffic Generator), all connected in ring topology. Used for executing all of the data plane tests including overlay tunnels and IPSec tests.

---

<sup>2</sup> <https://github.com/ligato>

- **2-Node Topology:** Consisting of one server acting as SUTs (Systems Under Test) and one server as TG (Traffic Generator), both connected in ring topology. Used for execution of tests without any overlay tunnel encapsulations. Added in CSIT rls18.07.

Current FD.io production testbeds are built with servers based on two processor generations of Intel Xeons: Haswell-SP (E5-2699v3) and Skylake (Platinum 8180). Testbeds built with servers based on Arm processors are in the process of being added to FD.io production.

Server SUT and DUT performance depends on server and processor type, hence results for testbeds based on different servers must be reported separately, and compared if appropriate.

Following sections describe existing production testbed types.

### 1.4.1 3-Node Xeon Haswell (3n-hsw)

3n-hsw testbed is based on three Cisco UCS-c240m3 servers each equipped with two Intel Xeon Haswell-SP E5-2699v3 2.3 GHz 18 core processors. Physical testbed topology is depicted in a figure below.

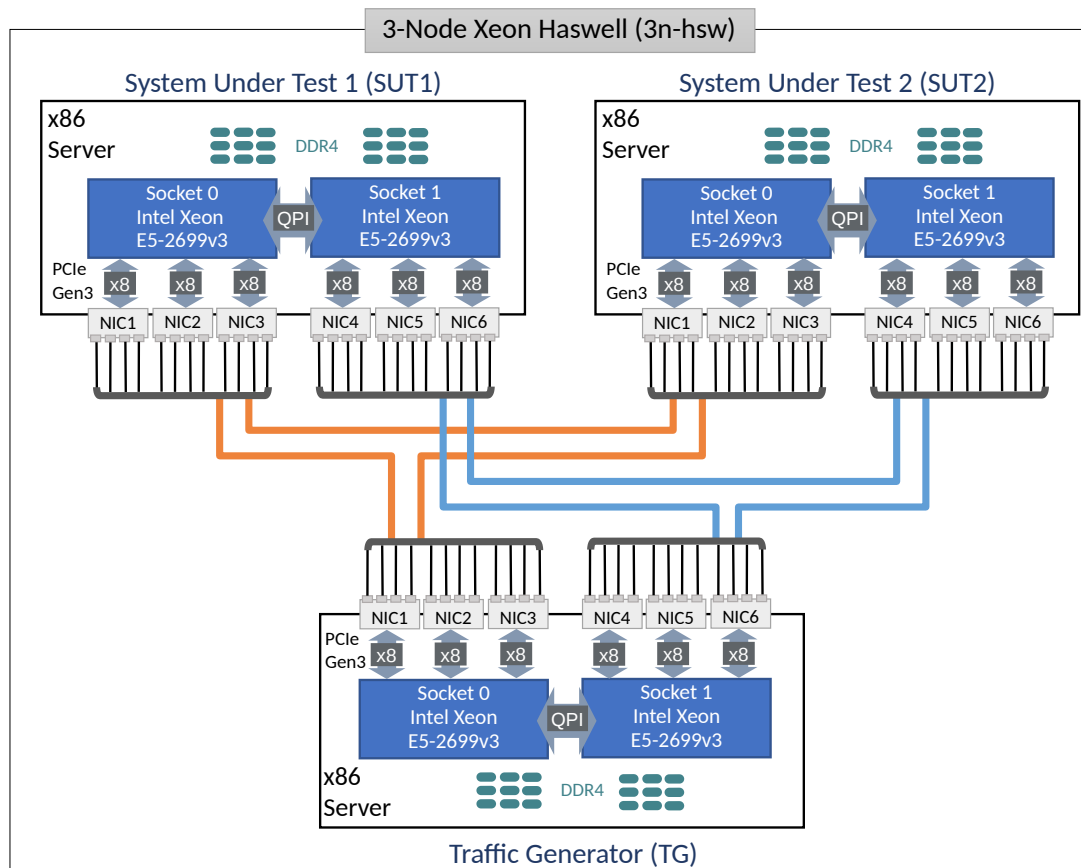

SUT1 and SUT2 servers are populated with the following NIC models:

1. NIC-1: VIC 1385 2p40GE Cisco.
2. NIC-2: NIC x520 2p10GE Intel.
3. NIC-3: empty.
4. NIC-4: NIC xI710-QDA2 2p40GE Intel.
5. NIC-5: NIC x710-DA2 2p10GE Intel.
6. NIC-6: QAT 8950 50G (Walnut Hill) Intel.

TG servers run T-Rex application and are populated with the following NIC models:



1. NIC-1: NIC xI710-QDA2 2p40GE Intel.
2. NIC-2: NIC x710-DA2 2p10GE Intel.
3. NIC-3: empty.
4. NIC-4: NIC xI710-QDA2 2p40GE Intel.
5. NIC-5: NIC x710-DA2 2p10GE Intel.
6. NIC-6: NIC x710-DA2 2p10GE Intel. (For self-tests.)

All Intel Xeon Haswell servers run with Intel Hyper-Threading disabled, making the number of logical cores exposed to Linux match the number of 18 physical cores per processor socket.

Complete 3n-hsw testbeds specification is available on [CSIT LF testbed<sup>3</sup>](#) wiki page.

Total of three 3n-hsw testbeds are in operation in FD.io labs.

### 1.4.2 3-Node Xeon Skylake (3n-skx)

3n-skx testbed is based on three SuperMicro SYS-7049GP-TRT servers each equipped with two Intel Xeon Skylake Platinum 8180 2.5 GHz 28 core processors. Physical testbed topology is depicted in a figure below.

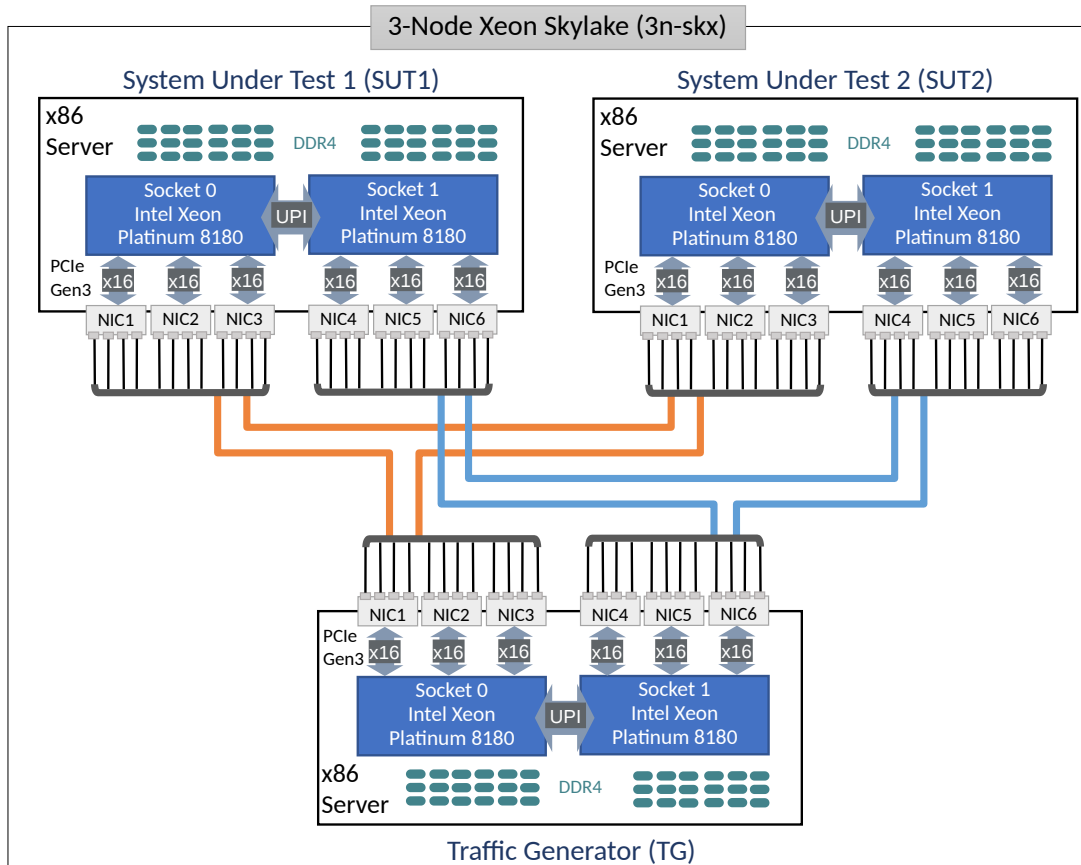

SUT1 and SUT2 servers are populated with the following NIC models:

1. NIC-1: x710-DA4 4p10GE Intel.
2. NIC-2: xxv710-DA2 2p25GE Intel.
3. NIC-3: empty, future expansion.

<sup>3</sup> [https://wiki.fd.io/view/CSIT/CSIT\\_LF\\_testbed](https://wiki.fd.io/view/CSIT/CSIT_LF_testbed)

4. NIC-4: empty, future expansion.
5. NIC-5: empty, future expansion.
6. NIC-6: empty, future expansion.

TG servers run T-Rex application and are populated with the following NIC models:

1. NIC-1: x710-DA4 4p10GE Intel.
2. NIC-2: xxv710-DA2 2p25GE Intel.
3. NIC-3: empty, future expansion.
4. NIC-4: empty, future expansion.
5. NIC-5: empty, future expansion.
6. NIC-6: x710-DA4 4p10GE Intel. (For self-tests.)

All Intel Xeon Skylake servers run with Intel Hyper-Threading enabled, doubling the number of logical cores exposed to Linux, with 56 logical cores and 28 physical cores per processor socket.

Complete 3n-skx testbeds specification is available on [CSIT LF lab extension](#)<sup>4</sup> wiki page.

Total of two 3n-skx testbeds are in operation in FD.io labs.

### 1.4.3 2-Node Xeon Skylake (2n-skx)

2n-skx testbed is based on two SuperMicro SYS-7049GP-TRT servers each equipped with two Intel Xeon Skylake Platinum 8180 2.5 GHz 28 core processors. Physical testbed topology is depicted in a figure below.

---

<sup>4</sup> [https://wiki.fd.io/view/CSIT/fdio\\_csit\\_lab\\_ext\\_llid\\_draft](https://wiki.fd.io/view/CSIT/fdio_csit_lab_ext_llid_draft)

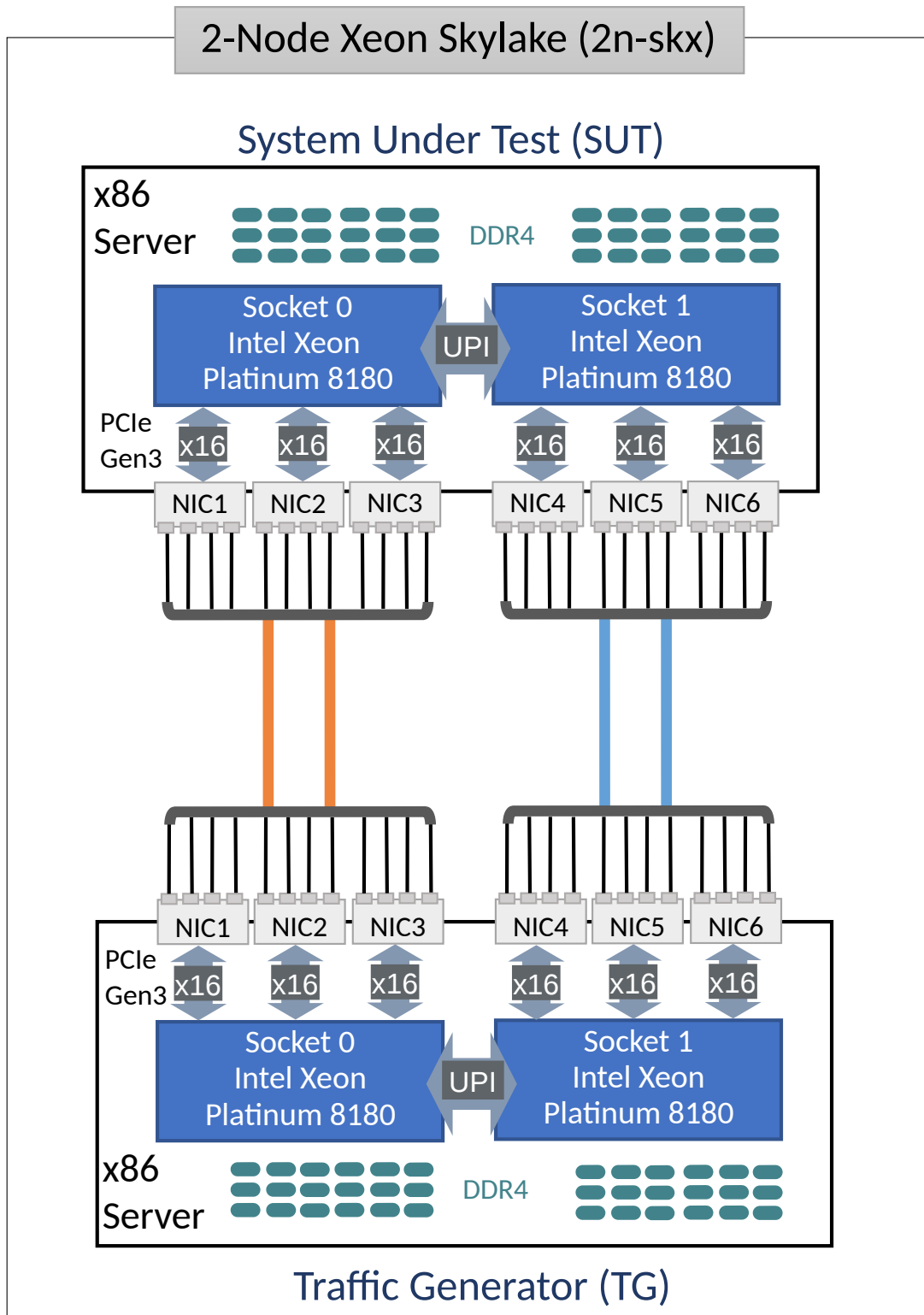

SUT servers are populated with the following NIC models:

1. NIC-1: x710-DA4 4p10GE Intel.
2. NIC-2: xxv710-DA2 2p25GE Intel.
3. NIC-3: mcx556a-edat ConnectX5 2p100GE Mellanox. (Not used yet.)
4. NIC-4: empty, future expansion.
5. NIC-5: empty, future expansion.

6. NIC-6: empty, future expansion.

TG servers run T-Rex application and are populated with the following NIC models:

1. NIC-1: x710-DA4 4p10GE Intel.
2. NIC-2: xxv710-DA2 2p25GE Intel.
3. NIC-3: mcx556a-edat ConnectX5 2p100GE Mellanox. (Not used yet.)
4. NIC-4: empty, future expansion.
5. NIC-5: empty, future expansion.
6. NIC-6: x710-DA4 4p10GE Intel. (For self-tests.)

All Intel Xeon Skylake servers run with Intel Hyper-Threading enabled, doubling the number of logical cores exposed to Linux, with 56 logical cores and 28 physical cores per processor socket.

Complete 2n-skx testbed specification is available on [CSIT/Testbeds: Xeon Skx, Arm, Atom](#)<sup>5</sup> wiki page.

Total of four 2n-skx testbeds are in operation in FD.io labs.

#### 1.4.4 2-Node Atom Denverton (2n-dnv)

2n-dnv testbed is based on one Intel Server Board S2600WFT that is equipped with two Intel Xeon Skylake Platinum 8180 2.5 GHz 28 core processors and one SuperMicro SYS-E300-9A server that is equipped with one SuperMicro A2SDi-TP8F motherboard. Physical testbed topology is depicted in a figure below.

---

<sup>5</sup> [https://wiki.fd.io/view/CSIT/Testbeds:\\_Xeon\\_Skx,\\_Arm,\\_Atom](https://wiki.fd.io/view/CSIT/Testbeds:_Xeon_Skx,_Arm,_Atom).

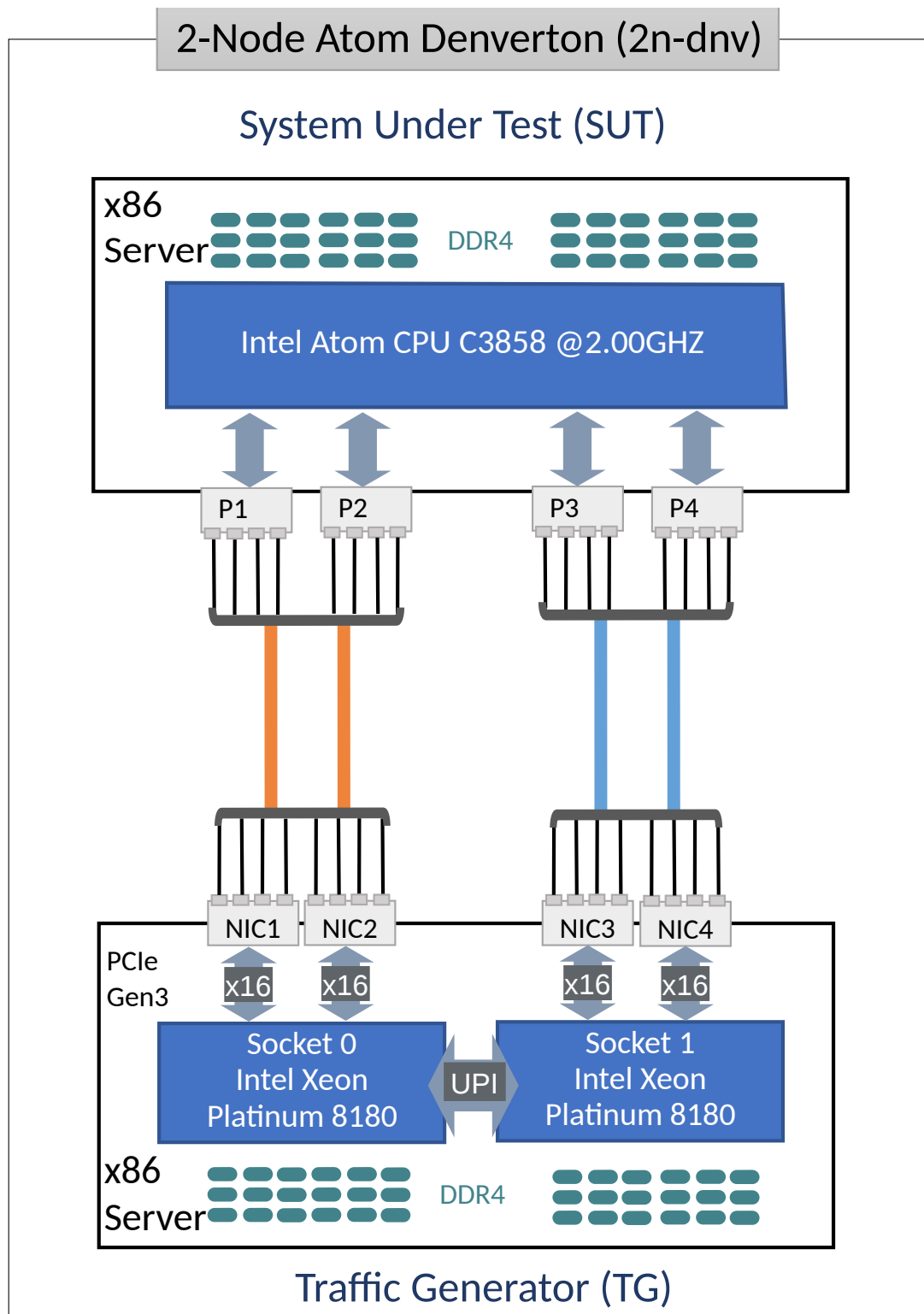

SUT server have four internal 10G NIC port:

1. P-1: x553 copper port.
2. P-2: x553 copper port.
3. P-3: x553 fiber port.
4. P-4: x553 fiber port.

TG server run T-Rex software traffic generator and are populated with the following NIC models:

1. NIC-1: x550-T2 2p10GE Intel.
2. NIC-2: x550-T2 2p10GE Intel.
3. NIC-3: x520-DA2 2p10GE Intel.
4. NIC-4: x520-DA2 2p10GE Intel.

The 2n-dnv testbed is in operation in Intel SH labs.

## 1.5 Test Methodology

### 1.5.1 VPP Forwarding Modes

VPP is tested in a number of L2 and IP packet lookup and forwarding modes. Within each mode baseline and scale tests are executed, the latter with varying number of lookup entries.

#### L2 Ethernet Switching

VPP is tested in three L2 forwarding modes:

- *l2patch*: L2 patch, the fastest point-to-point L2 path that loops packets between two interfaces without any Ethernet frame checks or lookups.
- *l2xc*: L2 cross-connect, point-to-point L2 path with all Ethernet frame checks, but no MAC learning and no MAC lookup.
- *l2bd*: L2 bridge-domain, multipoint-to-multipoint L2 path with all Ethernet frame checks, with MAC learning (unless static MACs are used) and MAC lookup.

l2bd tests are executed in baseline and scale configurations:

- *l2bdbase*: low number of L2 flows (254 per direction) is switched by VPP. They drive the content of MAC FIB size (508 total MAC entries). Both source and destination MAC addresses are incremented on a packet by packet basis.
- *l2bdscale*: high number of L2 flows is switched by VPP. Tested MAC FIB sizes include: i) 10k (5k unique flows per direction), ii) 100k (2x 50k flows) and iii) 1M (2x 500k). Both source and destination MAC addresses are incremented on a packet by packet basis, ensuring new entries are learned refreshed and looked up at every packet, making it the worst case scenario.

Ethernet wire encapsulations tested include: untagged, dot1q, dot1ad.

#### IPv4 Routing

IPv4 routing tests are executed in baseline and scale configurations:

- *ip4base*: low number of IPv4 flows (253 or 254 per direction) is routed by VPP. They drive the content of IPv4 FIB size (506 or 508 total /32 prefixes). Destination IPv4 addresses are incremented on a packet by packet basis.
- *ip4scale*: high number of IPv4 flows is routed by VPP. Tested IPv4 FIB sizes of /32 prefixes include: i) 20k (10k unique flows per direction), ii) 200k (2x 100k flows) and iii) 2M (2x 1M). Destination IPv4 addresses are incremented on a packet by packet basis, ensuring new FIB entries are looked up at every packet, making it the worst case scenario.

#### IPv6 Routing

IPv6 routing tests are executed in baseline and scale configurations:

- *ip6base*: low number of IPv6 flows (253 or 254 per direction) is routed by VPP. They drive the content of IPv6 FIB size (506 or 508 total /128 prefixes). Destination IPv6 addresses are incremented on a packet by packet basis.
- *ip6scale*: high number of IPv6 flows is routed by VPP. Tested IPv6 FIB sizes of /128 prefixes include: i) 20k (10k unique flows per direction), ii) 200k (2x 100k flows) and iii) 2M (2x 1M). Destination IPv6 addresses are incremented on a packet by packet basis, ensuring new FIB entries are looked up at every packet, making it the worst case scenario.

## SRv6 Routing

SRv6 routing tests are executed in a number of baseline configurations, in each case SR policy and steering policy are configured for one direction and one (or two) SR behaviours (functions) in the other directions:

- *srv6enc1sid*: One SID (no SRH present), one SR function - End.
- *srv6enc2sids*: Two SIDs (SRH present), two SR functions - End and End.DX6.
- *srv6enc2sids-nodecaps*: Two SIDs (SRH present) without decapsulation, one SR function - End.
- *srv6proxy-dyn*: Dynamic SRv6 proxy, one SR function - End.AD.
- *srv6proxy-masq*: Masquerading SRv6 proxy, one SR function - End.AM.
- *srv6proxy-stat*: Static SRv6 proxy, one SR function - End.AS.

In all listed cases low number of IPv6 flows (253 per direction) is routed by VPP.

## 1.5.2 Tunnel Encapsulations

Tunnel encapsulations testing is grouped based on the type of outer header: IPv4 or IPv6.

### IPv4 Tunnels

VPP is tested in the following IPv4 tunnel baseline configurations:

- *ip4vxlan-l2bdbase*: VXLAN over IPv4 tunnels with L2 bridge-domain MAC switching.
- *ip4vxlan-l2xcbase*: VXLAN over IPv4 tunnels with L2 cross-connect.
- *ip4lispip4-ip4base*: LISP over IPv4 tunnels with IPv4 routing.
- *ip4lispip6-ip6base*: LISP over IPv4 tunnels with IPv6 routing.

In all cases listed above low number of MAC, IPv4, IPv6 flows (254 or 253 per direction) is switched or routed by VPP.

In addition selected IPv4 tunnels are tested at scale:

- *dot1q-ip4vxlanscale-l2bd*: VXLAN over IPv4 tunnels with L2 bridge-domain MAC switching, with scaled up dot1q VLANs (10, 100, 1k), mapped to scaled up L2 bridge-domains (10, 100, 1k), that are in turn mapped to (10, 100, 1k) VXLAN tunnels. 64.5k flows are transmitted per direction.

### IPv6 Tunnels

VPP is tested in the following IPv6 tunnel baseline configurations:

- *ip6lispip4-ip4base*: LISP over IPv4 tunnels with IPv4 routing.
- *ip6lispip6-ip6base*: LISP over IPv4 tunnels with IPv6 routing.

In all cases listed above low number of IPv4, IPv6 flows (253 per direction) is routed by VPP.

### 1.5.3 VPP Features

VPP is tested in a number of data plane feature configurations across different forwarding modes. Following sections list features tested.

#### ACL Security-Groups

Both stateless and stateful access control lists (ACL), also known as security-groups, are supported by VPP.

Following ACL configurations are tested for MAC switching with L2 bridge-domains:

- *l2bdbasemaclrn-iacl{E}sl-{F}flows*: Input stateless ACL, with {E} entries and {F} flows.
- *l2bdbasemaclrn-oacl{E}sl-{F}flows*: Output stateless ACL, with {E} entries and {F} flows.
- *l2bdbasemaclrn-iacl{E}sf-{F}flows*: Input stateful ACL, with {E} entries and {F} flows.
- *l2bdbasemaclrn-oacl{E}sf-{F}flows*: Output stateful ACL, with {E} entries and {F} flows.

Following ACL configurations are tested with IPv4 routing:

- *ip4base-iacl{E}sl-{F}flows*: Input stateless ACL, with {E} entries and {F} flows.
- *ip4base-oacl{E}sl-{F}flows*: Output stateless ACL, with {E} entries and {F} flows.
- *ip4base-iacl{E}sf-{F}flows*: Input stateful ACL, with {E} entries and {F} flows.
- *ip4base-oacl{E}sf-{F}flows*: Output stateful ACL, with {E} entries and {F} flows.

ACL tests are executed with the following combinations of ACL entries and number of flows:

- ACL entry definitions
  - flow non-matching deny entry: (src-ip4, dst-ip4, src-port, dst-port).
  - flow matching permit ACL entry: (src-ip4, dst-ip4).
- {E} - number of non-matching deny ACL entries, {E} = [1, 10, 50].
- {F} - number of UDP flows with different tuple (src-ip4, dst-ip4, src-port, dst-port), {F} = [100, 10k, 100k].
- All {E}x{F} combinations are tested per ACL type, total of 9.

#### ACL MAC-IP

MAC-IP binding ACLs are tested for MAC switching with L2 bridge-domains:

- *l2bdbasemaclrn-macip-iacl{E}sl-{F}flows*: Input stateless ACL, with {E} entries and {F} flows.

MAC-IP ACL tests are executed with the following combinations of ACL entries and number of flows:

- ACL entry definitions
  - flow non-matching deny entry: (dst-ip4, dst-mac, bit-mask)
  - flow matching permit ACL entry: (dst-ip4, dst-mac, bit-mask)
- {E} - number of non-matching deny ACL entries, {E} = [1, 10, 50]
- {F} - number of UDP flows with different tuple (dst-ip4, dst-mac), {F} = [100, 10k, 100k]
- All {E}x{F} combinations are tested per ACL type, total of 9.



## NAT44

NAT44 is tested in baseline and scale configurations with IPv4 routing:

- *ip4base-nat44*: baseline test with single NAT entry (addr, port), single UDP flow.
- *ip4base-udpsrcscale{U}-nat44*: baseline test with {U} NAT entries (addr, {U}ports), {U}=15.
- *ip4scale{R}-udpsrcscale{U}-nat44*: scale tests with {R}\*{U} NAT entries ({R}addr, {U}ports), {R}=[100, 1k, 2k, 4k], {U}=15.

### 1.5.4 Data Plane Throughput

Network data plane packet and bandwidth throughput are measured in accordance with [RFC 2544](#)<sup>6</sup>, using FD.io CSIT Multiple Loss Ratio search (MLRsearch), an optimized throughput search algorithm, that measures SUT/DUT packet throughput rates at different Packet Loss Ratio (PLR) values.

Following MLRsearch values are measured across a range of L2 frame sizes and reported:

- NON DROP RATE (NDR): packet and bandwidth throughput at PLR=0%.
  - **Aggregate packet rate**: NDR\_LOWER <bi-directional packet rate> pps.
  - **Aggregate bandwidth rate**: NDR\_LOWER <bi-directional bandwidth rate> Gbps.
- PARTIAL DROP RATE (PDR): packet and bandwidth throughput at PLR=0.5%.
  - **Aggregate packet rate**: PDR\_LOWER <bi-directional packet rate> pps.
  - **Aggregate bandwidth rate**: PDR\_LOWER <bi-directional bandwidth rate> Gbps.

NDR and PDR are measured for the following L2 frame sizes (untagged Ethernet):

- IPv4 payload: 64B, IMIX (28x64B, 16x570B, 4x1518B), 1518B, 9000B.
- IPv6 payload: 78B, IMIX (28x78B, 16x570B, 4x1518B), 1518B, 9000B.

All rates are reported from external Traffic Generator perspective.

### 1.5.5 MLRsearch Tests

Multiple Loss Rate search (MLRsearch) tests use new search algorithm implemented in FD.io CSIT project. MLRsearch discovers multiple packet throughput rates in a single search, with each rate associated with a distinct Packet Loss Ratio (PLR) criteria. MLRsearch is being standardized in IETF with [draft-vpolak-mkonstan-mlrsearch-XX](#)<sup>7</sup>.

Two throughput measurements used in FD.io CSIT are Non-Drop Rate (NDR, with zero packet loss, PLR=0) and Partial Drop Rate (PDR, with packet loss rate not greater than the configured non-zero PLR). MLRsearch discovers NDR and PDR in a single pass reducing required execution time compared to separate binary searches for NDR and PDR. MLRsearch reduces execution time even further by relying on shorter trial durations of intermediate steps, with only the final measurements conducted at the specified final trial duration. This results in the shorter overall search execution time when compared to a standard NDR/PDR binary search, while guaranteeing the same or similar results.

If needed, MLRsearch can be easily adopted to discover more throughput rates with different pre-defined PLRs.

---

**Note:** All throughput rates are *always* bi-directional aggregates of two equal (symmetric) uni-directional packet rates received and reported by an external traffic generator.

---

<sup>6</sup> <https://tools.ietf.org/html/rfc2544.html>

<sup>7</sup> <https://tools.ietf.org/html/draft-vpolak-mkonstan-mlrsearch-00>

## Overview

The main properties of MLRsearch:

- MLRsearch is a duration aware multi-phase multi-rate search algorithm.
  - Initial phase determines promising starting interval for the search.
  - Intermediate phases progress towards defined final search criteria.
  - Final phase executes measurements according to the final search criteria.
- *Initial phase:*
  - Uses link rate as a starting transmit rate and discovers the Maximum Receive Rate (MRR) used as an input to the first intermediate phase.
- *Intermediate phases:*
  - Start with initial trial duration (in the first phase) and converge geometrically towards the final trial duration (in the final phase).
  - Track two values for NDR and two for PDR.
    - \* The values are called (NDR or PDR) lower\_bound and upper\_bound.
    - \* Each value comes from a specific trial measurement (most recent for that transmit rate), and as such the value is associated with that measurement's duration and loss.
    - \* A bound can be invalid, for example if NDR lower\_bound has been measured with nonzero loss.
    - \* Invalid bounds are not real boundaries for the searched value, but are needed to track interval widths.
    - \* Valid bounds are real boundaries for the searched value.
    - \* Each non-initial phase ends with all bounds valid.
  - Start with a large (lower\_bound, upper\_bound) interval width and geometrically converge towards the width goal (measurement resolution) of the phase. Each phase halves the previous width goal.
  - Use internal and external searches:
    - \* External search - measures at transmit rates outside the (lower\_bound, upper\_bound) interval. Activated when a bound is invalid, to search for a new valid bound by doubling the interval width. It is a variant of **exponential search**<sup>8</sup>.
    - \* Internal search - **binary search**<sup>9</sup>, measures at transmit rates within the (lower\_bound, upper\_bound) valid interval, halving the interval width.
- *Final phase* is executed with the final test trial duration, and the final width goal that determines resolution of the overall search. Intermediate phases together with the final phase are called non-initial phases.

The main benefits of MLRsearch vs. binary search include:

- In general MLRsearch is likely to execute more search trials overall, but less trials at a set final duration.
- In well behaving cases it greatly reduces (>50%) the overall duration compared to a single PDR (or NDR) binary search duration, while finding multiple drop rates.
- In all cases MLRsearch yields the same or similar results to binary search.
- Note: both binary search and MLRsearch are susceptible to reporting non-repeatable results across multiple runs for very bad behaving cases.

<sup>8</sup> [https://en.wikipedia.org/wiki/Exponential\\_search](https://en.wikipedia.org/wiki/Exponential_search)

<sup>9</sup> [https://en.wikipedia.org/wiki/Binary\\_search](https://en.wikipedia.org/wiki/Binary_search)

Caveats:

- Worst case MLRsearch can take longer than a binary search e.g. in case of drastic changes in behaviour for trials at varying durations.

## Search Implementation

Following is a brief description of the current MLRsearch implementation in FD.io CSIT.

### Input Parameters

1. *maximum\_transmit\_rate* - maximum packet transmit rate to be used by external traffic generator, limited by either the actual Ethernet link rate or traffic generator NIC model capabilities. Sample defaults: 2 \* 14.88 Mpps for 64B 10GE link rate, 2 \* 18.75 Mpps for 64B 40GE NIC maximum rate.
2. *minimum\_transmit\_rate* - minimum packet transmit rate to be used for measurements. MLRsearch fails if lower transmit rate needs to be used to meet search criteria. Default: 2 \* 10 kpps (could be higher).
3. *final\_trial\_duration* - required trial duration for final rate measurements. Default: 30 sec.
4. *initial\_trial\_duration* - trial duration for initial MLRsearch phase. Default: 1 sec.
5. *final\_relative\_width* - required measurement resolution expressed as (lower\_bound, upper\_bound) interval width relative to upper\_bound. Default: 0.5%.
6. *packet\_loss\_ratio* - maximum acceptable PLR search criteria for PDR measurements. Default: 0.5%.
7. *number\_of\_intermediate\_phases* - number of phases between the initial phase and the final phase. Impacts the overall MLRsearch duration. Less phases are required for well behaving cases, more phases may be needed to reduce the overall search duration for worse behaving cases. Default (2). (Value chosen based on limited experimentation to date. More experimentation needed to arrive to clearer guidelines.)

### Initial Phase

1. First trial measures at maximum rate and discovers MRR.
  - (a) *in*: trial\_duration = initial\_trial\_duration.
  - (b) *in*: offered\_transmit\_rate = maximum\_transmit\_rate.
  - (c) *do*: single trial.
  - (d) *out*: measured loss ratio.
  - (e) *out*: mrr = measured receive rate.
2. Second trial measures at MRR and discovers MRR2.
  - (a) *in*: trial\_duration = initial\_trial\_duration.
  - (b) *in*: offered\_transmit\_rate = MRR.
  - (c) *do*: single trial.
  - (d) *out*: measured loss ratio.
  - (e) *out*: mrr2 = measured receive rate.
3. Third trial measures at MRR2.
  - (a) *in*: trial\_duration = initial\_trial\_duration.
  - (b) *in*: offered\_transmit\_rate = MRR2.

- (c) *do*: single trial.
- (d) *out*: measured loss ratio.

## Non-initial Phases

### 1. Main loop:

- (a) *in*: *trial\_duration* for the current phase. Set to *initial\_trial\_duration* for the first intermediate phase; to *final\_trial\_duration* for the final phase; or to the element of interpolating geometric sequence for other intermediate phases. For example with two intermediate phases, *trial\_duration* of the second intermediate phase is the geometric average of *initial\_trial\_duration* and *final\_trial\_duration*.
- (b) *in*: *relative\_width\_goal* for the current phase. Set to *final\_relative\_width* for the final phase; doubled for each preceding phase. For example with two intermediate phases, the first intermediate phase uses quadruple of *final\_relative\_width* and the second intermediate phase uses double of *final\_relative\_width*.
- (c) *in*: *ndr\_interval*, *pdr\_interval* from the previous main loop iteration or the previous phase. If the previous phase is the initial phase, both intervals have *lower\_bound* = MRR2, *upper\_bound* = MRR. Note that the initial phase is likely to create intervals with invalid bounds.
- (d) *do*: According to the procedure described in point 2, either exit the phase (by jumping to 1.g.), or prepare new transmit rate to measure with.
- (e) *do*: Perform the trial measurement at the new transmit rate and *trial\_duration*, compute its loss ratio.
- (f) *do*: Update the bounds of both intervals, based on the new measurement. The actual update rules are numerous, as NDR external search can affect PDR interval and vice versa, but the result agrees with rules of both internal and external search. For example, any new measurement below an invalid *lower\_bound* becomes the new *lower\_bound*, while the old measurement (previously acting as the invalid *lower\_bound*) becomes a new and valid *upper\_bound*. Go to next iteration (1.c.), taking the updated intervals as new input.
- (g) *out*: current *ndr\_interval* and *pdr\_interval*. In the final phase this is also considered to be the result of the whole search. For other phases, the next phase loop is started with the current results as an input.

### 2. New transmit rate (or exit) calculation (for 1.d.):

- If there is an invalid bound then prepare for external search:
  - If the most recent measurement at NDR *lower\_bound* transmit rate had the loss higher than zero, then the new transmit rate is NDR *lower\_bound* decreased by two NDR interval widths.
  - Else, if the most recent measurement at PDR *lower\_bound* transmit rate had the loss higher than PLR, then the new transmit rate is PDR *lower\_bound* decreased by two PDR interval widths.
  - Else, if the most recent measurement at NDR *upper\_bound* transmit rate had no loss, then the new transmit rate is NDR *upper\_bound* increased by two NDR interval widths.
  - Else, if the most recent measurement at PDR *upper\_bound* transmit rate had the loss lower or equal to PLR, then the new transmit rate is PDR *upper\_bound* increased by two PDR interval widths.
- If interval width is higher than the current phase goal:
  - Else, if NDR interval does not meet the current phase width goal, prepare for internal search. The new transmit rate is  $(\text{NDR lower bound} + \text{NDR upper bound}) / 2$ .
  - Else, if PDR interval does not meet the current phase width goal, prepare for internal search. The new transmit rate is  $(\text{PDR lower bound} + \text{PDR upper bound}) / 2$ .

- Else, if some bound has still only been measured at a lower duration, prepare to re-measure at the current duration (and the same transmit rate). The order of priorities is:
  - NDR lower\_bound,
  - PDR lower\_bound,
  - NDR upper\_bound,
  - PDR upper\_bound.
- Else, do not prepare any new rate, to exit the phase. This ensures that at the end of each non-initial phase all intervals are valid, narrow enough, and measured at current phase trial duration.

### Implementation Deviations

This document so far has been describing a simplified version of MLRsearch algorithm. The full algorithm as implemented contains additional logic, which makes some of the details (but not general ideas) above incorrect. Here is a short description of the additional logic as a list of principles, explaining their main differences from (or additions to) the simplified description, but without detailing their mutual interaction.

1. *Logarithmic transmit rate.* In order to better fit the relative width goal, the interval doubling and halving is done differently. For example, the middle of 2 and 8 is 4, not 5.
2. *Optimistic maximum rate.* The increased rate is never higher than the maximum rate. Upper bound at that rate is always considered valid.
3. *Pessimistic minimum rate.* The decreased rate is never lower than the minimum rate. If a lower bound at that rate is invalid, a phase stops refining the interval further (until it gets re-measured).
4. *Conservative interval updates.* Measurements above current upper bound never update a valid upper bound, even if drop ratio is low. Measurements below current lower bound always update any lower bound if drop ratio is high.
5. *Ensure sufficient interval width.* Narrow intervals make external search take more time to find a valid bound. If the new transmit increased or decreased rate would result in width less than the current goal, increase/decrease more. This can happen if the measurement for the other interval makes the current interval too narrow. Similarly, take care the measurements in the initial phase create wide enough interval.
6. *Timeout for bad cases.* The worst case for MLRsearch is when each phase converges to intervals way different than the results of the previous phase. Rather than suffer total search time several times larger than pure binary search, the implemented tests fail themselves when the search takes too long (given by argument *timeout*).

### 1.5.6 (B)MRR Throughput

Maximum Receive Rate (MRR) tests are complementary to MLRsearch tests, as they provide a maximum “raw” throughput benchmark for development and testing community. MRR tests measure the packet forwarding rate under the maximum load offered by traffic generator over a set trial duration, regardless of packet loss. Maximum load for specified Ethernet frame size is set to the bi-directional link rate.

In CSIT-1901 MRR test code has been updated with a configurable burst MRR parameters: trial duration and number of trials in a single burst. This enabled a new Burst MRR (BMRR) methodology for more precise performance trending.

Current parameters for BMRR tests:

- Ethernet frame sizes: 64B (78B for IPv6), IMIX, 1518B, 9000B; all quoted sizes include frame CRC, but exclude per frame transmission overhead of 20B (preamble, inter frame gap).

- Maximum load offered: 10GE, 25GE and 40GE link (sub-)rates depending on NIC tested, with the actual packet rate depending on frame size, transmission overhead and traffic generator NIC forwarding capacity.
  - For 10GE NICs the maximum packet rate load is  $2 * 14.88$  Mpps for 64B, a 10GE bi-directional link rate.
  - For 25GE NICs the maximum packet rate load is  $2 * 18.75$  Mpps for 64B, a 25GE bi-directional link sub-rate limited by TG 25GE NIC used, XXV710.
  - For 40GE NICs the maximum packet rate load is  $2 * 18.75$  Mpps for 64B, a 40GE bi-directional link sub-rate limited by TG 40GE NIC used, XL710. Packet rate for other tested frame sizes is limited by PCIe Gen3 x8 bandwidth limitation of ~50Gbps.
- Trial duration: 1 sec.
- Number of trials per burst: 10.

Similarly to NDR/PDR throughput tests, MRR test should be reporting bi-directional link rate (or NIC rate, if lower) if tested VPP configuration can handle the packet rate higher than bi-directional link rate, e.g. large packet tests and/or multi-core tests.

MRR tests are currently used for FD.io CSIT continuous performance trending and for comparison between releases. Daily trending job tests subset of frame sizes, focusing on 64B (78B for IPv6) for all tests and IMIX for selected tests (vhost, memif).

MRR-like measurements are being used to establish starting conditions for experimental Probabilistic Loss Ratio Search (PLRsearch) used for soak testing, aimed at verifying continuous system performance over an extended period of time, hours, days, weeks, months. PLRsearch code is currently in experimental phase in FD.io CSIT project.

### 1.5.7 Packet Latency

TRex Traffic Generator (TG) is used for measuring latency of VPP DUTs. Reported latency values are measured using following methodology:

- Latency tests are performed at 100% of discovered NDR and PDR rates for each throughput test and packet size (except IMIX).
- TG sends dedicated latency streams, one per direction, each at the rate of 9 kpps at the prescribed packet size; these are sent in addition to the main load streams.
- TG reports min/avg/max latency values per stream direction, hence two sets of latency values are reported per test case; future release of TRex is expected to report latency percentiles.
- Reported latency values are aggregate across two SUTs if the three node topology is used for given performance test; for per SUT latency, reported value should be divided by two.
- 1usec is the measurement accuracy advertised by TRex TG for the setup used in FD.io labs used by CSIT project.
- TRex setup introduces an always-on error of about  $2 * 2$ usec per latency flow additional Tx/Rx interface latency induced by TRex SW writing and reading packet timestamps on CPU cores without HW acceleration on NICs closer to the interface line.

### 1.5.8 Multi-Core Speedup

All performance tests are executed with single processor core and with multiple cores scenarios.

#### Intel Hyper-Threading (HT)

Intel Xeon processors used in FD.io CSIT can operate either in HT Disabled mode (single logical core per each physical core) or in HT Enabled mode (two logical cores per each physical core). HT setting is applied

in BIOS and requires server SUT reload for it to take effect, making it impractical for continuous changes of HT mode of operation.

CSIT-1901 performance tests are executed with server SUTs' Intel XEON processors configured with Intel Hyper-Threading Disabled for all Xeon Haswell testbeds (3n-hsw) and with Intel Hyper-Threading Enabled for all Xeon Skylake testbeds.

More information about physical testbeds is provided in *Physical Testbeds* (page 4).

### Multi-core Tests

CSIT-1901 multi-core tests are executed in the following VPP worker thread and physical core configurations:

1. Intel Xeon Haswell testbeds (3n-hsw) with Intel HT disabled (1 logical CPU core per each physical core):
  1. 1t1c - 1 VPP worker thread on 1 physical core.
  2. 2t2c - 2 VPP worker threads on 2 physical cores.
  3. 4t4c - 4 VPP worker threads on 4 physical cores.
1. Intel Xeon Skylake testbeds (2n-skx, 3n-skx) with Intel HT enabled (2 logical CPU cores per each physical core):
  1. 2t1c - 2 VPP worker threads on 1 physical core.
  2. 4t2c - 4 VPP worker threads on 2 physical cores.
  3. 8t4c - 8 VPP worker threads on 4 physical cores.

VPP worker threads are the data plane threads running on isolated logical cores. With Intel HT enabled VPP workers are placed as sibling threads on each used physical core. VPP control threads (main, stats) are running on a separate non-isolated core together with other Linux processes.

In all CSIT tests care is taken to ensure that each VPP worker handles the same amount of received packet load and does the same amount of packet processing work. This is achieved by evenly distributing per interface type (e.g. physical, virtual) receive queues over VPP workers using default VPP round-robin mapping and by loading these queues with the same amount of packet flows.

If number of VPP workers is higher than number of physical or virtual interfaces, multiple receive queues are configured on each interface. NIC Receive Side Scaling (RSS) for physical interfaces and multi-queue for virtual interfaces are used for this purpose.

Section *Speedup Multi-Core* (page 339) includes a set of graphs illustrating packet throughput speedup when running VPP worker threads on multiple cores. Note that in quite a few test cases running VPP workers on 2 or 4 physical cores hits the I/O bandwidth or packets-per-second limit of tested NIC.

### 1.5.9 VPP Startup Settings

CSIT code manipulates a number of VPP settings in startup.conf for optimized performance. List of common settings applied to all tests and test dependent settings follows.

See [VPP startup.conf](#)<sup>10</sup> for a complete set and description of listed settings.

#### Common Settings

List of vpp startup.conf settings applied to all tests:

1. heap-size <value> - set separately for ip4, ip6, stats, main depending on scale tested.

---

<sup>10</sup> <https://git.fd.io/vpp/tree/src/vpp/conf/startup.conf?h=stable/1901>

2. no-tx-checksum-offload - disables UDP / TCP TX checksum offload in DPDK. Typically needed for use faster vector PMDs (together with no-multi-seg).
3. socket-mem <value>,<value> - memory per numa. (Not required anymore due to VPP code changes, will be removed in CSIT-19.04.)

### Per Test Settings

List of vpp startup.conf settings applied dynamically per test:

1. corelist-workers <list\_of\_cores> - list of logical cores to run VPP worker data plane threads. Depends on HyperThreading and core per test configuration.
2. num-rx-queues <value> - depends on a number of VPP threads and NIC interfaces.
3. num-rx-desc/num-tx-desc - number of rx/tx descriptors for specific NICs, incl. xl710, x710, xxv710.
4. num-mbufs <value> - increases number of buffers allocated, needed only in scenarios with large number of interfaces and worker threads. Value is per CPU socket. Default is 16384.
5. no-multi-seg - disables multi-segment buffers in DPDK, improves packet throughput, but disables Jumbo MTU support. Disabled for all tests apart from the ones that require Jumbo 9000B frame support.
6. UIO driver - depends on topology file definition.
7. QAT VFs - depends on NRThreads, each thread = 1QAT VFs.

#### 1.5.10 KVM VMs vhost-user

FD.io CSIT performance lab is testing VPP vhost with KVM VMs using following environment settings:

- Tests with varying Qemu virtio queue (a.k.a. vring) sizes: [vr1024] 1024 descriptors to optimize for packet throughput.
- Tests with varying Linux CFS (Completely Fair Scheduler) settings: [cfs] default settings, [cfsrr1] CFS RoundRobin(1) policy applied to all data plane threads handling test packet path including all VPP worker threads and all Qemu testpmd poll-mode threads.
- Resulting test cases are all combinations with [vr1024] and [cfs,cfsrr1] settings.
- Adjusted Linux kernel CFS scheduler policy for data plane threads used in CSIT is documented in [CSIT Performance Environment Tuning wiki](#)<sup>11</sup>.
- The purpose is to verify performance impact (MRR and NDR/PDR throughput) and same test measurements repeatability, by making VPP and VM data plane threads less susceptible to other Linux OS system tasks hijacking CPU cores running those data plane threads.

#### 1.5.11 LXC/DRC Container Memif

CSIT includes tests taking advantage of VPP memif virtual interface (shared memory interface) to interconnect VPP running in Containers. VPP vswitch instance runs in bare-metal user-mode handling NIC interfaces and connecting over memif (Slave side) to VPPs running in LINUX CONTAINER (LXC) or in Docker Container (DRC) configured with memif (Master side). LXCs and DRCs run in a privileged mode with VPP data plane worker threads pinned to dedicated physical CPU cores per usual CSIT practice. All VPP instances run the same version of software. This test topology is equivalent to existing tests with vhost-user and VMs as described earlier in *Logical Topologies* (page 31).

In addition to above vswitch tests, a single memif interface test is executed. It runs in a simple topology of two VPP container instances connected over memif interface in order to verify standalone memif interface performance.

<sup>11</sup> <https://wiki.fd.io/view/CSIT/csit-perf-env-tuning-ubuntu1604>



More information about CSIT LXC and DRC setup and control is available in *Container Orchestration in CSIT* (page 706).

### 1.5.12 K8s Container Memif

CSIT includes tests of VPP topologies running in K8s orchestrated Pods/Containers and connected over memif virtual interfaces. In order to provide simple topology coding flexibility and extensibility container orchestration is done with **Kubernetes**<sup>12</sup> using **Docker**<sup>13</sup> images for all container applications including VPP. **Ligato**<sup>14</sup> is used for the Pod/Container networking orchestration that is integrated with K8s, including memif support.

In these tests VPP vswitch runs in a K8s Pod with Docker Container (DRC) handling NIC interfaces and connecting over memif to more instances of VPP running in Pods/DRCs. All DRCs run in a privileged mode with VPP data plane worker threads pinned to dedicated physical CPU cores per usual CSIT practice. All VPP instances run the same version of software. This test topology is equivalent to existing tests with vhost-user and VMs as described earlier in *Physical Testbeds* (page 4).

Further documentation is available in *Container Orchestration in CSIT* (page 706).

### 1.5.13 NFV Service Density

Network Function Virtualization (NFV) service density tests focus on measuring total per server throughput at varied NFV service “packing” densities with vswitch providing host dataplane. The goal is to compare and contrast performance of a shared vswitch for different network topologies and virtualization technologies, and their impact on vswitch performance and efficiency in a range of NFV service configurations.

Each NFV service instance consists of a set of Network Functions (NFs), running in VMs (VNFs) or in Containers (CNFs), that are connected into a virtual network topology using VPP vswitch running in Linux user-mode. Multiple service instances share the vswitch that in turn provides per service chain forwarding context(s). In order to provide a most complete picture, each network topology and service configuration is tested in different service density setups by varying two parameters:

- Number of service instances (e.g. 1,2,4..10).
- Number of NFs per service instance (e.g. 1,2,4..10).

The initial implementation of NFV service density tests in CSIT-1901 is using two NF applications:

- VNF: DPDK L3fwd running in KVM VM, configured with /8 IPv4 prefix routing. L3fwd got chosen as a lightweight fast IPv4 VNF application, and follows CSIT approach of using DPDK sample applications in VMs for performance testing.
- CNF: VPP running in Docker Container, configured with /24 IPv4 prefix routing. VPP got chosen as a fast IPv4 NF application that supports required memif interface (L3fwd does not). This is similar to all other Container tests in CSIT that use VPP.

Tests are designed such that in all tested cases VPP vswitch is the most stressed application, as for each flow vswitch is processing each packet multiple times, whereas VNFs and CNFs process each packets only once. To that end, all VNFs and CNFs are allocated enough resources to not become a bottleneck.

### Service Configurations

Following NFV network topologies and configurations are tested:

- VNF Service Chains (VSC) with L2 vswitch

---

<sup>12</sup> <https://github.com/kubernetes>

<sup>13</sup> <https://github.com/docker>

<sup>14</sup> <https://github.com/ligato>

- *Network Topology*: Sets of VNFs dual-homed to VPP vswitch over virtio-vhost links. Each set belongs to separate service instance.
- *Network Configuration*: VPP L2 bridge-domain contexts form logical service chains of VNF sets and connect each chain to physical interfaces.
- CNF Service Chains (CSC) with L2 vswitch
  - *Network Topology*: Sets of CNFs dual-homed to VPP vswitch over memif links. Each set belongs to separate service instance.
  - *Network Configuration*: VPP L2 bridge-domain contexts form logical service chains of CNF sets and connect each chain to physical interfaces.
- CNF Service Pipelines (CSP) with L2 vswitch
  - *Network Topology*: Sets of CNFs connected into pipelines over a series of memif links, with edge CNFs single-homed to VPP vswitch over memif links. Each set belongs to separate service instance.
  - *Network Configuration*: VPP L2 bridge-domain contexts connect each CNF pipeline to physical interfaces.

### Thread-to-Core Mapping

CSIT defines specific ratios for mapping software threads of vswitch and VNFs/CNFs to physical cores, with separate ratios defined for main control threads and data-plane threads.

In CSIT-1901 NFV service density tests run on Intel Xeon testbeds with Intel Hyper-Threading enabled, so each physical core is associated with a pair of sibling logical cores corresponding to the hyper-threads.

CSIT-1901 executes tests with the following software thread to physical core mapping ratios:

- vSwitch
  - Data-plane on single core
    - \* (data:core) = (1:1) => 2dt1c - 2 Data-plane Threads on 1 Core.
    - \* (main:core) = (1:1) => 1mt1c - 1 Main Thread on 1 Core.
  - Data-plane on two cores
    - \* (data:core) = (1:2) => 4dt2c - 4 Data-plane Threads on 2 Cores.
    - \* (main:core) = (1:1) => 1mt1c - 1 Main Thread on 1 Core.
- VNF and CNF
  - Data-plane on single core
    - \* (data:core) = (1:1) => 2dt1c - 2 Data-plane Threads on 1 Core per NF.
    - \* (main:core) = (2:1) => 2mt1c - 2 Main Threads on 1 Core, 1 Thread per NF, core shared between two NFs.

Maximum tested service densities are limited by a number of physical cores per NUMA. CSIT-1901 allocates cores within NUMA0. Support for multi NUMA tests is to be added in future release.

#### 1.5.14 VPP\_Device Functional

CSIT-1901 added new VPP\_Device test environment for functional VPP device tests integrated into LFN CI/CD infrastructure. VPP\_Device tests run on 1-Node testbeds (1n-skx, 1n-arm) and rely on Linux SRIOV Virtual Function (VF), dot1q VLAN tagging and external loopback cables to facilitate packet passing over external physical links. Initial focus is on few baseline tests. Existing CSIT VIRT tests can be moved to VPP\_Device framework by changing L1 and L2 KW(s). RF test definition code stays unchanged with the

exception of requiring adjustments from 3-Node to 2-Node logical topologies. CSIT VIRT to VPP\_Device migration is expected in the next CSIT release.

### 1.5.15 IPsec on Intel QAT

VPP IPsec performance tests are using DPDK cryptodev device driver in combination with HW cryptodev devices - Intel QAT 8950 50G - present in LF FD.io physical testbeds. DPDK cryptodev can be used for all IPsec data plane functions supported by VPP.

Currently CSIT-1901 implements following IPsec test cases:

- AES-GCM, CBC-SHA1 ciphers, in combination with IPv4 routed-forwarding with Intel xl710 NIC.
- CBC-SHA1 ciphers, in combination with LISP-GPE overlay tunneling for IPv4-over-IPv4 with Intel xl710 NIC.

### 1.5.16 TRex Traffic Generator

#### Usage

TRex traffic generator<sup>15</sup> is used for all CSIT performance tests. TRex stateless mode is used to measure NDR and PDR throughputs using MLRsearch and to measure maximum transfer rate in MRR tests.

TRex is installed and run on the TG compute node. The typical procedure is:

- If the TRex is not already installed on TG, it is installed in the suite setup phase - see [TRex installation](#)<sup>16</sup>.
- TRex configuration is set in its configuration file

```
/etc/trex_cfg.yaml
```

- TRex is started in the background mode

```
$ sh -c 'cd <t-rex-install-dir>/scripts/ && sudo nohup ./t-rex-64 -i -c 7 --iom 0 > /tmp/trex.  
↪log 2>&1 &' > /dev/null
```

- There are traffic streams dynamically prepared for each test, based on traffic profiles. The traffic is sent and the statistics obtained using `trex_stl_lib.api.STLClient`.

#### Measuring Packet Loss

Following sequence is followed to measure packet loss:

- Create an instance of STLClient.
- Connect to the client.
- Add all streams.
- Clear statistics.
- Send the traffic for defined time.
- Get the statistics.

If there is a warm-up phase required, the traffic is sent also before test and the statistics are ignored.

---

<sup>15</sup> <https://wiki.fd.io/view/TRex>

<sup>16</sup> [https://git.fd.io/csit/tree/resources/tools/trex/trex\\_installer.sh?h=rls1901](https://git.fd.io/csit/tree/resources/tools/trex/trex_installer.sh?h=rls1901)

## Measuring Latency

If measurement of latency is requested, two more packet streams are created (one for each direction) with TReX flow\_stats parameter set to STLFlowLatencyStats. In that case, returned statistics will also include min/avg/max latency values.

### 1.5.17 HTTP/TCP with WRK Tool

WRK HTTP benchmarking tool<sup>17</sup> is used for experimental TCP/IP and HTTP tests of VPP TCP/IP stack and built-in static HTTP server. WRK has been chosen as it is capable of generating significant TCP/IP and HTTP loads by scaling number of threads across multi-core processors.

This in turn enables quite high scale benchmarking of the main TCP/IP and HTTP service including HTTP TCP/IP Connections-Per-Second (CPS), HTTP Requests-Per-Second and HTTP Bandwidth Throughput.

The initial tests are designed as follows:

- HTTP and TCP/IP Connections-Per-Second (CPS)
  - WRK configured to use 8 threads across 8 cores, 1 thread per core.
  - Maximum of 50 concurrent connections across all WRK threads.
  - Timeout for server responses set to 5 seconds.
  - Test duration is 30 seconds.
  - Expected HTTP test sequence:
    - \* Single HTTP GET Request sent per open connection.
    - \* Connection close after valid HTTP reply.
    - \* Resulting flow sequence - 8 packets: >Syn, <Syn-Ack, >Ack, >Req, <Rep, >Fin, <Fin, >Ack.
- HTTP Requests-Per-Second
  - WRK configured to use 8 threads across 8 cores, 1 thread per core.
  - Maximum of 50 concurrent connections across all WRK threads.
  - Timeout for server responses set to 5 seconds.
  - Test duration is 30 seconds.
  - Expected HTTP test sequence:
    - \* Multiple HTTP GET Requests sent in sequence per open connection.
    - \* Connection close after set test duration time.
    - \* Resulting flow sequence: >Syn, <Syn-Ack, >Ack, >Req[1], <Rep[1], ..., >Req[n], <Rep[n], >Fin, <Fin, >Ack.

### 1.5.18 PLRsearch

#### Abstract algorithm

Eventually, a better description of the abstract search algorithm will appear at this IETF standard: [plrsearch draft](#)<sup>18</sup>.

<sup>17</sup> <https://github.com/wg/wrk>

<sup>18</sup> <https://tools.ietf.org/html/draft-vpolak-bmwg-plrsearch-00>

## Motivation

Network providers are interested in throughput a device can sustain.

[RFC 2544](#)<sup>19</sup> assumes loss ratio is given by a deterministic function of offered load. But NFV software devices are not deterministic (enough). This leads for deterministic algorithms (such as MLRsearch with single trial) to return results, which when repeated show relatively high standard deviation, thus making it harder to tell what “the throughput” actually is.

We need another algorithm, which takes this indeterminism into account.

## Model

Each algorithm searches for an answer to a precisely formulated question. When the question involves indeterministic systems, it has to specify probabilities (or prior distributions) which are tied to a specific probabilistic model. Different models will have different number (and meaning) of parameters. Complicated (but more realistic) models have many parameters, and the math involved can be very convoluted. It is better to start with simpler probabilistic model, and only change it when the output of the simpler algorithm is not stable or useful enough.

This document is focused on algorithms related to packet loss count only. No latency (or other information) is taken into account. For simplicity, only one type of measurement is considered: dynamically computed offered load, constant within trial measurement of predetermined trial duration.

The main idea of the search algorithm is to iterate trial measurements, using [Bayesian inference](#)<sup>20</sup> to compute both the current estimate of “the throughput” and the next offered load to measure at. The computations are done in parallel with the trial measurements.

The following algorithm makes an assumption that packet traffic generator detects duplicate packets on receive detection, and reports this as an error.

## Poisson distribution

For given offered load, number of packets lost during trial measurement is assumed to come from [Poisson distribution](#)<sup>21</sup>, each trial is assumed to be independent, and the (unknown) Poisson parameter (average number of packets lost per second) is assumed to be constant across trials.

When comparing different offered loads, the average loss per second is assumed to increase, but the (deterministic) function from offered load into average loss rate is otherwise unknown. This is called “loss function”.

Given a target loss ratio (configurable), there is an unknown offered load when the average is exactly that. We call that the “critical load”. If critical load seems higher than maximum offerable load, we should use the maximum offerable load to make search output more conservative.

Side note: [Binomial distribution](#)<sup>22</sup> is a better fit compared to Poisson distribution (acknowledging that the number of packets lost cannot be higher than the number of packets offered), but the difference tends to be relevant in loads far above the critical region, so using Poisson distribution helps the algorithm focus on critical region better.

Of course, there are great many increasing functions (as candidates for loss function). The offered load has to be chosen for each trial, and the computed posterior distribution of critical load changes with each trial result.

To make the space of possible functions more tractable, some other simplifying assumptions are needed. As the algorithm will be examining (also) loads close to the critical load, linear approximation to the loss function in the critical region is important. But as the search algorithm needs to evaluate the function

---

<sup>19</sup> <https://tools.ietf.org/html/rfc2544>

<sup>20</sup> [https://en.wikipedia.org/wiki/Bayesian\\_statistics](https://en.wikipedia.org/wiki/Bayesian_statistics)

<sup>21</sup> [https://en.wikipedia.org/wiki/Poisson\\_distribution](https://en.wikipedia.org/wiki/Poisson_distribution)

<sup>22</sup> [https://en.wikipedia.org/wiki/Binomial\\_distribution](https://en.wikipedia.org/wiki/Binomial_distribution)

also far away from the critical region, the approximate function has to be well-behaved for every positive offered load, specifically it cannot predict non-positive packet loss rate.

Within this document, “fitting function” is the name for such a well-behaved function, which approximates the unknown loss function in the critical region.

Results from trials far from the critical region are likely to affect the critical rate estimate negatively, as the fitting function does not need to be a good approximation there. Discarding some results, or “suppressing” their impact with ad-hoc methods (other than using Poisson distribution instead of binomial) is not used, as such methods tend to make the overall search unstable. We rely on most of measurements being done (eventually) within the critical region, and overweighting far-off measurements (eventually) for well-behaved fitting functions.

Speaking about new trials, each next trial will be done at offered load equal to the current average of the critical load. Alternative methods for selecting offered load might be used, in an attempt to speed up convergence, but such methods tend to be specific for a particular system under tests.

### Fitting function coefficients distribution

To accommodate systems with different behaviours, the fitting function is expected to have few numeric parameters affecting its shape (mainly affecting the linear approximation in the critical region).

The general search algorithm can use whatever increasing fitting function, some specific functions can be described later.

It is up to the implementer to choose a fitting function and prior distribution of its parameters. The rest of this document assumes each parameter is independently and uniformly distributed over a common interval. Implementers are to add non-linear transformations into their fitting functions if their prior is different.

Exit condition for the search is either critical load stdev becoming small enough, or overall search time becoming long enough.

The algorithm should report both avg and stdev for critical load. If the reported averages follow a trend (without reaching equilibrium), avg and stdev should refer to the equilibrium estimates based on the trend, not to immediate posterior values.

### Integration

The posterior distributions for fitting function parameters will not be integrable in general.

The search algorithm utilises the fact that trial measurement takes some time, so this time can be used for numeric integration (using suitable method, such as Monte Carlo) to achieve sufficient precision.

### Optimizations

After enough trials, the posterior distribution will be concentrated in a narrow area of parameter space. The integration method should take advantage of that.

Even in the concentrated area, the likelihood can be quite small, so the integration algorithm should track the logarithm of the likelihood, and also avoid underflow errors by other means.

### FD.io CSIT Implementation Specifics

The search receives min\_rate and max\_rate values, to avoid measurements at offered loads not supported by the traffic generator.

The implemented test cases use bidirectional traffic. The algorithm stores each rate as bidirectional rate (internally, the algorithm is agnostic to flows and directions, it only cares about overall counts of packets sent and packets lost), but debug output from traffic generator lists unidirectional values.

## Measurement delay

In a sample implementation in FD.io CSIT project, there is roughly 0.5 second delay between trials due to restrictions imposed by packet traffic generator in use (T-Rex).

As measurements results come in, posterior distribution computation takes more time (per sample), although there is a considerable constant part (mostly for inverting the fitting functions).

Also, the integrator needs a fair amount of samples to reach the region the posterior distribution is concentrated at.

And of course, speed of the integrator depends on computing power of the CPU the algorithm is able to use.

All those timing related effects are addressed by arithmetically increasing trial durations with configurable coefficients (currently 10.2 seconds for the first trial, each subsequent trial being 0.2 second longer).

## Rounding errors and underflows

In order to avoid them, the current implementation tracks natural logarithm (instead of the original quantity) for any quantity which is never negative. Logarithm of zero is minus infinity (not supported by Python), so special value "None" is used instead. Specific functions for frequent operations (such as "logarithm of sum of exponentials") are defined to handle None correctly.

## Fitting functions

Current implementation uses two fitting functions. In general, their estimates for critical rate differ, which adds a simple source of systematic error, on top of randomness error reported by integrator. Otherwise the reported stdev of critical rate estimate is unrealistically low.

Both functions are not only increasing, but convex (meaning the rate of increase is also increasing).

As **primitive function**<sup>23</sup> to any positive function is an increasing function, and primitive function to any increasing function is convex function; both fitting functions were constructed as double primitive function to a positive function (even though the intermediate increasing function is easier to describe).

As not any function is integrable, some more realistic functions (especially with respect to behavior at very small offered loads) are not easily available.

Both fitting functions have a "central point" and a "spread", varied by simply shifting and scaling (in x-axis, the offered load direction) the function to be doubly integrated. Scaling in y-axis (the loss rate direction) is fixed by the requirement of transfer rate staying nearly constant in very high offered loads.

In both fitting functions (as they are a double primitive function to a symmetric function), the "central point" turns out to be equal to the aforementioned limiting transfer rate, so the fitting function parameter is named "mrr", the same quantity our Maximum Receive Rate tests are designed to measure.

Both fitting functions return logarithm of loss rate, to avoid rounding errors and underflows. Parameters and offered load are not given as logarithms, as they are not expected to be extreme, and the formulas are simpler that way.

Both fitting functions have several mathematically equivalent formulas, each can lead to an overflow or underflow in different places. Overflows can be eliminated by using different exact formulas for different argument ranges. Underflows can be avoided by using approximate formulas in affected argument ranges, such ranges have their own formulas to compute. At the end, both fitting function implementations contain multiple "if" branches, discontinuities are a possibility at range boundaries.

---

<sup>23</sup> <https://en.wikipedia.org/wiki/Antiderivative>

Offered load for next trial measurement is the average of critical rate estimate. During each measurement, two estimates are computed, even though only one (in alternating order) is used for next offered load.

### Stretch function

The original function (before applying logarithm) is primitive function to **logistic function**<sup>24</sup>. The name “stretch” is used for related function in context of neural networks with sigmoid activation function.

### Erf function

The original function is double primitive function to **Gaussian function**<sup>25</sup>. The name “erf” comes from error function, the first primitive to Gaussian.

### Prior distributions

The numeric integrator expects all the parameters to be distributed (independently and) uniformly on an interval (-1, 1).

As both “mrr” and “spread” parameters are positive and not dimensionless, a transformation is needed. Dimensionality is inherited from max\_rate value.

The “mrr” parameter follows a **Lomax distribution**<sup>26</sup> with alpha equal to one, but shifted so that mrr is always greater than 1 packet per second.

The “stretch” parameter is generated simply as the “mrr” value raised to a random power between zero and one; thus it follows a **reciprocal distribution**<sup>27</sup>.

### Integrator

After few measurements, the posterior distribution of fitting function arguments gets quite concentrated into a small area. The integrator is using **Monte Carlo**<sup>28</sup> with **importance sampling**<sup>29</sup> where the biased distribution is **bivariate Gaussian**<sup>30</sup> distribution, with deliberately larger variance. If the generated sample falls outside (-1, 1) interval, another sample is generated.

The center and the variance for the biased distribution has three sources. First is a prior information. After enough samples are generated, the biased distribution is constructed from a mixture of two sources. Top 12 most weight samples, and all samples (the mix ratio is computed from the relative weights of the two populations). When integration (run along a particular measurement) is finished, the mixture bias distribution is used as the prior information for the next integration.

This combination showed the best behavior, as the integrator usually follows two phases. First phase (where the top 12 samples are dominating) is mainly important for locating the new area the posterior distribution is concentrated at. The second phase (dominated by whole sample population) is actually relevant for the critical rate estimation.

<sup>24</sup> [https://en.wikipedia.org/wiki/Logistic\\_function](https://en.wikipedia.org/wiki/Logistic_function)

<sup>25</sup> [https://en.wikipedia.org/wiki/Gaussian\\_function](https://en.wikipedia.org/wiki/Gaussian_function)

<sup>26</sup> [https://en.wikipedia.org/wiki/Lomax\\_distribution](https://en.wikipedia.org/wiki/Lomax_distribution)

<sup>27</sup> [https://en.wikipedia.org/wiki/Reciprocal\\_distribution](https://en.wikipedia.org/wiki/Reciprocal_distribution)

<sup>28</sup> [https://en.wikipedia.org/wiki/Monte\\_Carlo\\_integration](https://en.wikipedia.org/wiki/Monte_Carlo_integration)

<sup>29</sup> [https://en.wikipedia.org/wiki/Importance\\_sampling](https://en.wikipedia.org/wiki/Importance_sampling)

<sup>30</sup> [https://en.wikipedia.org/wiki/Multivariate\\_normal\\_distribution](https://en.wikipedia.org/wiki/Multivariate_normal_distribution)



## Caveats

Current implementation does not constrict the critical rate (as computed for every sample) to the `min_rate`, `max_rate` interval.

Earlier implementations were targeting loss rate (as opposed to loss ratio). The chosen fitting functions do allow arbitrarily low loss ratios, but may suffer from rounding errors in corresponding parameter regions. Internal loss rate target is computed from given loss ratio using the current trial offered load, which increases search instability, especially if measurements with surprisingly high loss count appear.

As high loss count measurements add many bits of information, they need a large amount of small loss count measurements to balance them, making the algorithm converge quite slowly.

Some systems evidently do not follow the assumption of repeated measurements having the same average loss rate (when offered load is the same). The idea of estimating the trend is not implemented at all, as the observed trends have varied characteristics.

Probably, using a more realistic fitting functions will give better estimates than trend analysis.

## Graphical example

The following picture shows the estimated average of the critical rate computed by the two fitting functions after each trial measurement within the 30 minute duration of a PLRsearch test run.

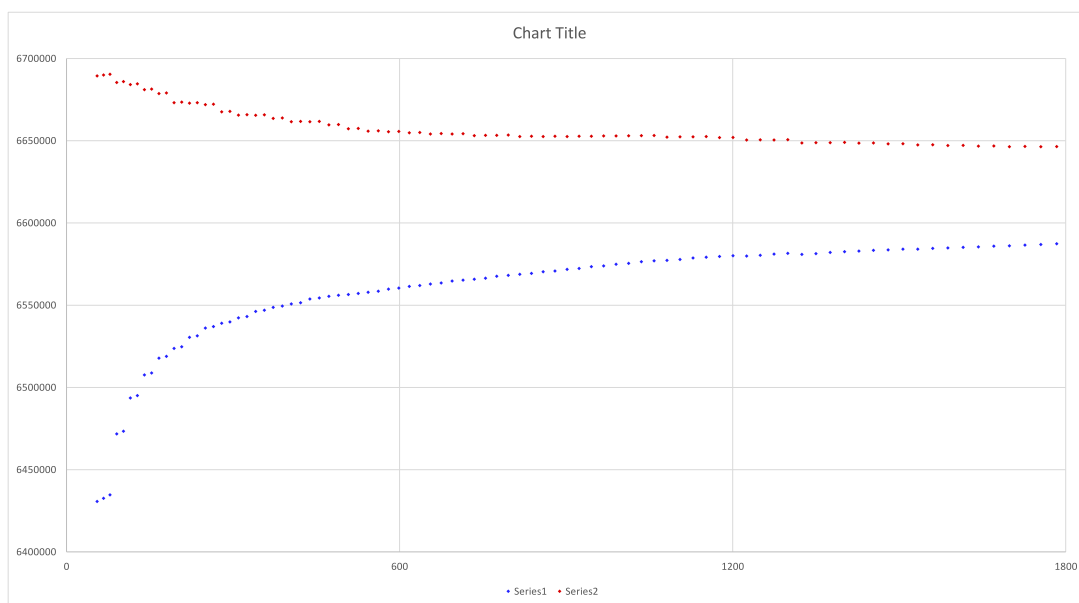

### 2.1 Overview

VPP performance test results are reported for all three physical testbed types present in FD.io labs: 3-Node Xeon Haswell (3n-hsw), 3-Node Xeon Skylake (3n-skx), 2-Node Xeon Skylake (2n-skx) and installed NIC models. For description of physical testbeds used for VPP performance tests please refer to *Physical Testbeds* (page 4).

#### 2.1.1 Logical Topologies

CSIT VPP performance tests are executed on physical testbeds described in *Physical Testbeds* (page 4). Based on the packet path thru server SUTs, three distinct logical topology types are used for VPP DUT data plane testing:

1. NIC-to-NIC switching topologies.
2. VM service switching topologies.
3. Container service switching topologies.

#### NIC-to-NIC Switching

The simplest logical topology for software data plane application like VPP is NIC-to-NIC switching. Tested topologies for 2-Node and 3-Node testbeds are shown in figures below.

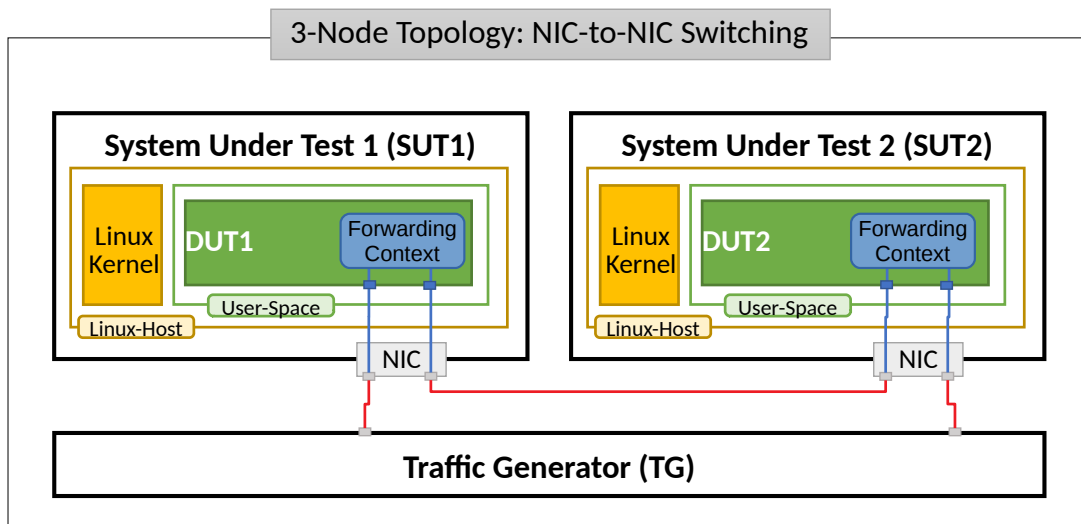
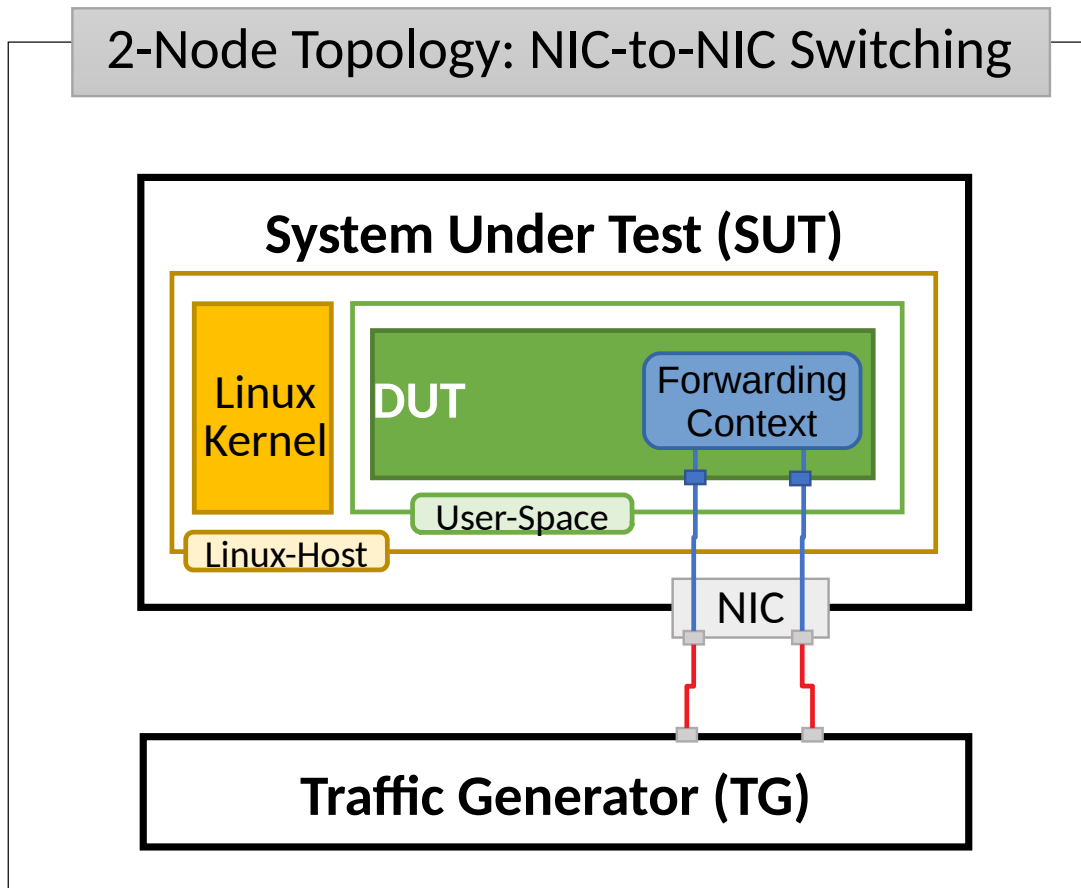

Server Systems Under Test (SUT) run VPP application in Linux user-mode as a Device Under Test (DUT). Server Traffic Generator (TG) runs T-Rex application. Physical connectivity between SUTs and TG is provided using different drivers and NIC models that need to be tested for performance (packet/bandwidth throughput and latency).

From SUT and DUT perspectives, all performance tests involve forwarding packets between two (or more) physical Ethernet ports (10GE, 25GE, 40GE, 100GE). In most cases both physical ports on SUT are located on the same NIC. The only exceptions are link bonding and 100GE tests. In the latter case only one port per NIC can be driven at linerate due to PCIe Gen3 x16 slot bandwidth limiations. 100GE NICs are not supported in PCIe Gen3 x8 slots.

Note that reported VPP DUT performance results are specific to the SUTs tested. SUTs with other processors than the ones used in FD.io lab are likely to yield different results. A good rule of thumb, that can be applied to estimate VPP packet throughput for NIC-to-NIC switching topology, is to expect the forwarding performance to be proportional to processor core frequency for the same processor architecture, assuming processor is the only limiting factor and all other SUT parameters are equivalent to FD.io CSIT environment.

### VM Service Switching

VM service switching topology test cases require VPP DUT to communicate with Virtual Machines (VMs) over vhost-user virtual interfaces.

Two types of VM service topologies are tested in CSIT-1901:

1. "Parallel" topology with packets flowing within SUT from NIC(s) via VPP DUT to VM, back to VPP DUT, then out thru NIC(s).
2. "Chained" topology (a.k.a. "Snake") with packets flowing within SUT from NIC(s) via VPP DUT to VM, back to VPP DUT, then to the next VM, back to VPP DUT and so on and so forth until the last VM in a chain, then back to VPP DUT and out thru NIC(s).

For each of the above topologies, VPP DUT is tested in a range of L2 or IPv4/IPv6 configurations depending on the test suite. Sample VPP DUT "Chained" VM service topologies for 2-Node and 3-Node testbeds with each SUT running N of VM instances is shown in the figures below.

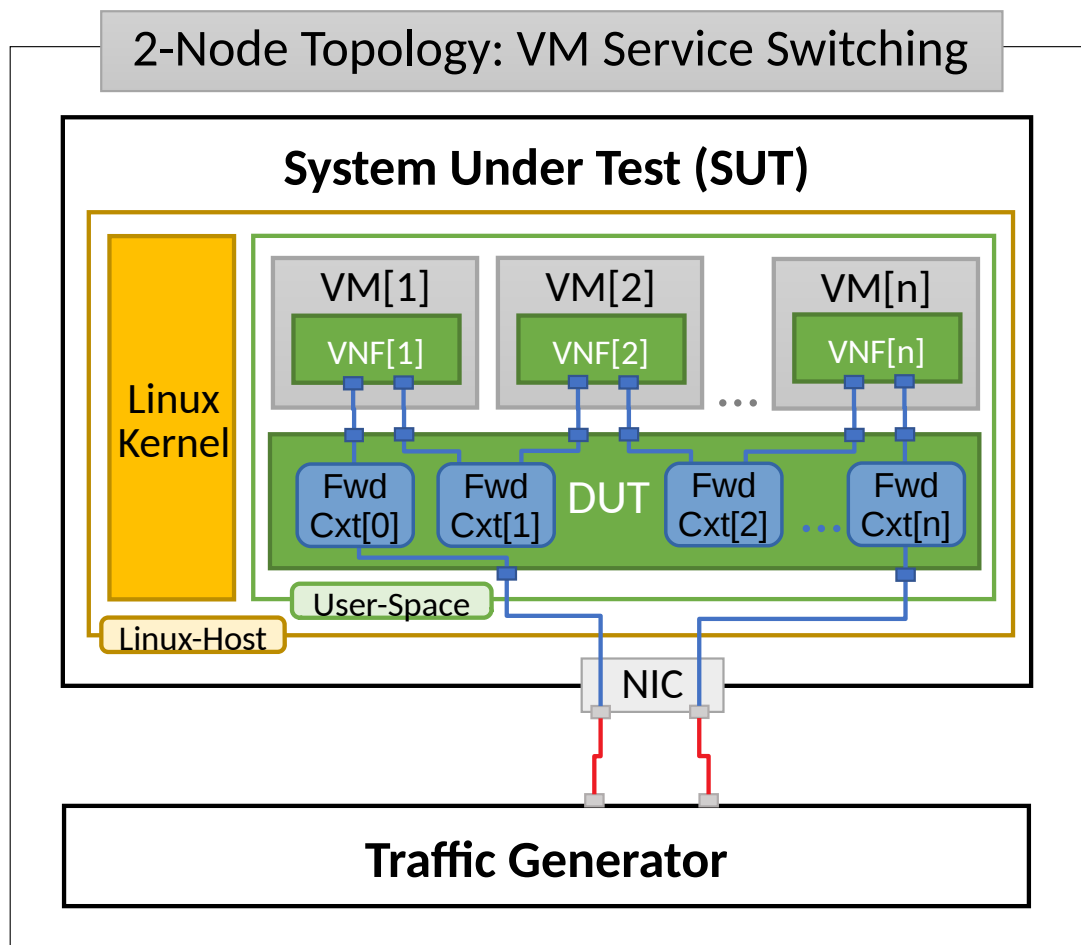

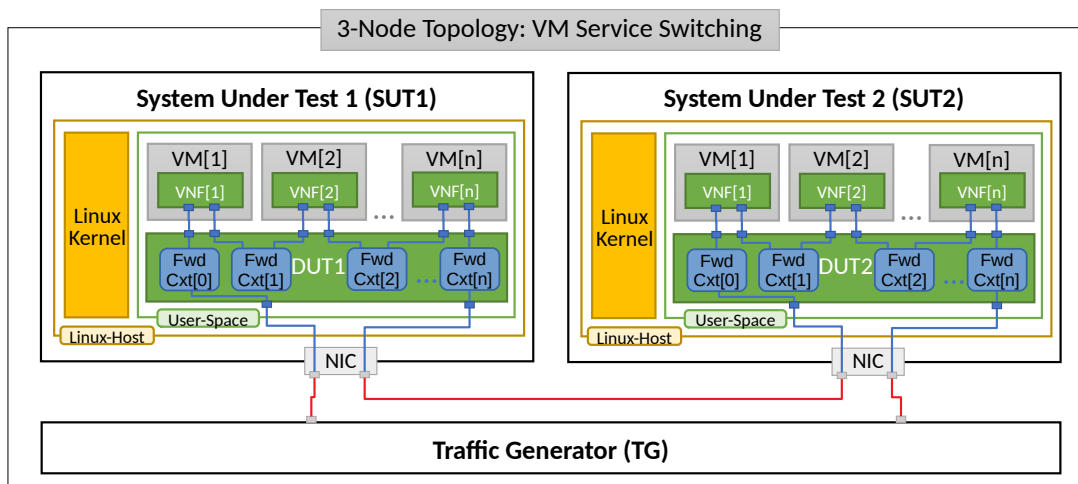

In “Chained” VM topologies, packets are switched by VPP DUT multiple times: twice for a single VM, three times for two VMs,  $N+1$  times for  $N$  VMs. Hence the external throughput rates measured by TG and listed in this report must be multiplied by  $N+1$  to represent the actual VPP DUT aggregate packet forwarding rate.

For “Parallel” service topology packets are always switched twice by VPP DUT per service chain.

Note that reported VPP DUT performance results are specific to the SUTs tested. SUTs with other processor than the ones used in FD.io lab are likely to yield different results. Similarly to NIC-to-NIC switching topology, here one can also expect the forwarding performance to be proportional to processor core frequency for the same processor architecture, assuming processor is the only limiting factor. However due to much higher dependency on intensive memory operations in VM service chained topologies and sensitivity to Linux scheduler settings and behaviour, this estimation may not always yield good enough accuracy.

### Container Service Switching

Container service switching topology test cases require VPP DUT to communicate with Containers (Ctrs) over memif virtual interfaces.

Three types of VM service topologies are tested in CSIT-1901:

1. “Parallel” topology with packets flowing within SUT from NIC(s) via VPP DUT to Container, back to VPP DUT, then out thru NIC(s).
2. “Chained” topology (a.k.a. “Snake”) with packets flowing within SUT from NIC(s) via VPP DUT to Container, back to VPP DUT, then to the next Container, back to VPP DUT and so on and so forth until the last Container in a chain, then back to VPP DUT and out thru NIC(s).
3. “Horizontal” topology with packets flowing within SUT from NIC(s) via VPP DUT to Container, then via “horizontal” memif to the next Container, and so on and so forth until the last Container, then back to VPP DUT and out thru NIC(s).

For each of the above topologies, VPP DUT is tested in a range of L2 or IPv4/IPv6 configurations depending on the test suite. Sample VPP DUT “Chained” Container service topologies for 2-Node and 3-Node testbeds with each SUT running  $N$  of Container instances is shown in the figures below.

## 2-Node Topology: Container Service Switching

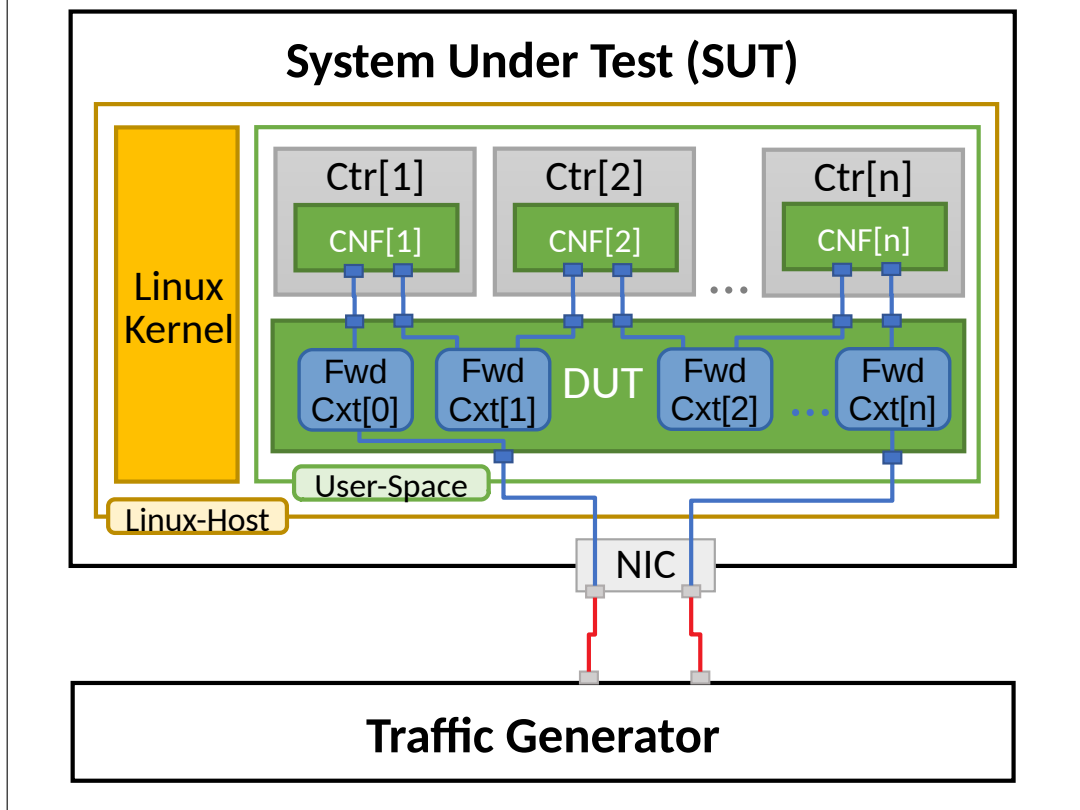

## 3-Node Topology: Container Service Switching

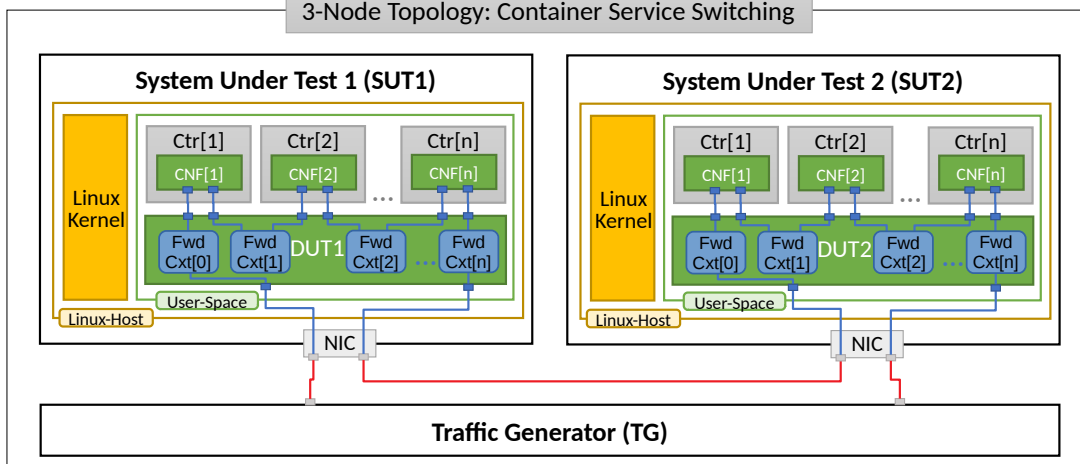

In “Chained” Container topologies, packets are switched by VPP DUT multiple times: twice for a single Container, three times for two Containers,  $N+1$  times for  $N$  Containers. Hence the external throughput rates measured by TG and listed in this report must be multiplied by  $N+1$  to represent the actual VPP DUT aggregate packet forwarding rate.

For a “Parallel” and “Horizontal” service topologies packets are always switched by VPP DUT twice per service chain.

Note that reported VPP DUT performance results are specific to the SUTs tested. SUTs with other processor than the ones used in FD.io lab are likely to yield different results. Similarly to NIC-to-NIC switching topology, here one can also expect the forwarding performance to be proportional to processor core frequency for the same processor architecture, assuming processor is the only limiting factor. However due

to much higher dependency on intensive memory operations in Container service chained topologies and sensitivity to Linux scheduler settings and behaviour, this estimation may not always yield good enough accuracy.

## 2.1.2 Performance Tests Coverage

Performance tests measure following metrics for tested VPP DUT topologies and configurations:

- Packet Throughput: measured in accordance with **RFC 2544**<sup>31</sup>, using FD.io CSIT Multiple Loss Ratio search (MLRsearch), an optimized binary search algorithm, producing throughput at different Packet Loss Ratio (PLR) values:
  - Non Drop Rate (NDR): packet throughput at PLR=0%.
  - Partial Drop Rate (PDR): packet throughput at PLR=0.5%.
- One-Way Packet Latency: measured at different offered packet loads:
  - 100% of discovered NDR throughput.
  - 100% of discovered PDR throughput.
- Maximum Receive Rate (MRR): measure packet forwarding rate under the maximum load offered by traffic generator over a set trial duration, regardless of packet loss. Maximum load for specified Ethernet frame size is set to the bi-directional link rate.

CSIT-1901 includes following VPP data plane functionality performance tested across a range of NIC drivers and NIC models:

---

<sup>31</sup> <https://tools.ietf.org/html/rfc2544.html>

Functionality	Description
ACL	L2 Bridge-Domain switching and IPv4 and IPv6 routing with iACL and oACL IP address, MAC address and L4 port security.
COP	IPv4 and IPv6 routing with COP address security.
IPv4	IPv4 routing.
IPv6	IPv6 routing.
IPv4 Scale	IPv4 routing with 20k, 200k and 2M FIB entries.
IPv6 Scale	IPv6 routing with 20k, 200k and 2M FIB entries.
IPSecHW	IPSec encryption with AES-GCM, CBC-SHA1 ciphers, in combination with IPv4 routing. Intel QAT HW acceleration.
IPSec+LISP	IPSec encryption with CBC-SHA1 ciphers, in combination with LISP-GPE overlay tunneling for IPv4-over-IPv4.
IPSecSW	IPSec encryption with AES-GCM, CBC-SHA1 ciphers, in combination with IPv4 routing.
K8s Containers Memif	K8s orchestrated container VPP service chain topologies connected over the memif virtual interface.
KVM VMs vhost-user	Virtual topologies with service chains of 1 and 2 VMs using vhost-user interfaces, with different VPP forwarding modes incl. L2XC, L2BD, VXLAN with L2BD, IPv4 routing.
L2BD	L2 Bridge-Domain switching of untagged Ethernet frames with MAC learning; disabled MAC learning i.e. static MAC tests to be added.
L2BD Scale	L2 Bridge-Domain switching of untagged Ethernet frames with MAC learning; disabled MAC learning i.e. static MAC tests to be added with 20k, 200k and 2M FIB entries.
L2XC	L2 Cross-Connect switching of untagged, dot1q, dot1ad VLAN tagged Ethernet frames.
LISP	LISP overlay tunneling for IPv4-over-IPv4, IPv6-over-IPv4, IPv6-over-IPv6, IPv4-over-IPv6 in IPv4 and IPv6 routing modes.
LXC/DRC Containers Memif	Container VPP memif virtual interface tests with different VPP forwarding modes incl. L2XC, L2BD.
NAT	(Source) Network Address Translation tests with varying number of users and ports per user.
QoS Policer	Ingress packet rate measuring, marking and limiting (IPv4).
SRv6 Routing	Segment Routing IPv6 tests.
VPP TCP/IP stack	Tests of VPP TCP/IP stack used with VPP built-in HTTP server.
VTS	Virtual Topology System use case tests combining VXLAN overlay tunneling with L2BD, ACL and KVM VM vhost-user features.
VXLAN	VXLAN overlay tunnelling integration with L2XC and L2BD.

Execution of performance tests takes time, especially the throughput tests. Due to limited HW testbed resources available within FD.io labs hosted by LF, the number of tests for some NIC models has been limited to few baseline tests.

### 2.1.3 Performance Tests Naming

FD.io CSIT-1901 follows a common structured naming convention for all performance and system functional tests, introduced in CSIT-17.01.

The naming should be intuitive for majority of the tests. Complete description of FD.io CSIT test naming convention is provided on *Test Naming* (page 864).



## 2.2 Release Notes

### 2.2.1 Changes in CSIT-1901

#### 1. VPP PERFORMANCE TESTS

- **Service density 2n-skx tests:** Network Function Virtualization (NFV) service density tests focus on measuring total per server throughput at varied NFV service *packing* densities with vswitch providing host dataplane. The goal is to compare and contrast performance of a shared vswitch for different network topologies and virtualization technologies, and their impact on vswitch performance and efficiency in a range of NFV service configurations.
- **Experimental Soak Tests:** Added performance soak tests framework code for extended time duration tests and throughput discovery at given PLR and at give total test time e.g. minutes, hours, days, weeks, months, years. See updated *Test Methodology* (page 11) section for more details.

#### 2. TEST FRAMEWORK

- **Container code optimizations:** Optimized container library allows to run containre\_memif tests faster.
- **CSIT PAPI Support:** Continue converting existing VAT L1 keywords to PAPI L1 KWs in CSIT using VPP Python bindings. Required for migrating away from VAT.
- **General Code Housekeeping:** Ongoing RF keywords optimizations, removal of redundant RF keywords.

#### 3. PRESENTATION AND ANALYTICS LAYER

- **Graphs Layout Improvements:** Improved performance graphs layout for better readability and maintenance: test grouping, axis labels, descriptions, other informative decoration.

## 2.2.2 Known Issues

List of known issues in CSIT-1901 for VPP performance tests:

#	JiraID	Issue Description
1	<a href="https://jira.fd.io/browse/CSIT-570">CSIT-570</a> <sup>32</sup>	Sporadic (1 in 200) NDR discovery test failures on x520. DPDK reporting rx-errors, indicating L1 issue. Suspected issue with HW combination of X710-X520 in LF testbeds. Not observed outside of LF testbeds.
2	<a href="https://jira.fd.io/browse/VPP-1562">VPP-1562</a> <sup>33</sup>	Link bonding (mode LACP, transmit policy l34) test are failing due to VPP crashing producing core dump.
3	<a href="https://jira.fd.io/browse/CSIT-1427">CSIT-1427</a> <sup>34</sup>	Scale HW IPsec are failing due to issue with selecting ipsec backend in VPP.
4	<a href="https://jira.fd.io/browse/VPP-1563">VPP-1563</a> <sup>35</sup>	AVF L2patch tests are failing for all packet size and core combination. Reason: null-node blackholed packets in show error.
5	<a href="https://jira.fd.io/browse/CSIT-1234">CSIT-1234</a> <sup>36</sup>	VPP IPsecHW/IPSecsW scale interface mode, low NDR and PDR 64B throughput in 3n-hsw testbeds, in CSIT-19.01 vs. CSIT-18.10.
6	<a href="https://jira.fd.io/browse/CSIT-1428">CSIT-1428</a> <sup>37</sup>	VM vhost tests with RXQ 2 and more are failing and reporting incorrect measurements due to RXQ configuration issue.
7	<a href="https://jira.fd.io/browse/CSIT-1431">CSIT-1431</a> <sup>38</sup>	AVF 4 cores tests are sporadically failing.

<sup>32</sup> <https://jira.fd.io/browse/CSIT-570>

<sup>33</sup> <https://jira.fd.io/browse/VPP-1562>

<sup>34</sup> <https://jira.fd.io/browse/CSIT-1427>

<sup>35</sup> <https://jira.fd.io/browse/VPP-1563>

<sup>36</sup> <https://jira.fd.io/browse/CSIT-1234>

<sup>37</sup> <https://jira.fd.io/browse/CSIT-1428>

<sup>38</sup> <https://jira.fd.io/browse/CSIT-1431>

## 2.3 Packet Throughput

Throughput graphs are generated by multiple executions of the same performance tests across physical testbeds hosted LF FD.io labs: 3n-hsw, 2n-skx, 2n-skx. Box-and-Whisker plots are used to display variations in measured throughput values, without making any assumptions of the underlying statistical distribution.

For each test case, Box-and-Whisker plots show the quartiles (Min, 1st quartile / 25th percentile, 2nd quartile / 50th percentile / mean, 3rd quartile / 75th percentile, Max) across collected data set. Outliers are plotted as individual points.

Additional information about graph data:

1. **Graph Title:** describes tested packet path, testbed topology, processor model, NIC model, packet size, number of cores and threads used by data plane workers and indication of VPP DUT configuration.
2. **X-axis Labels:** indices of individual test suites as listed in Graph Legend.
3. **Y-axis Labels:** measured Packets Per Second [pps] throughput values.
4. **Graph Legend:** lists X-axis indices with associated CSIT test suites executed to generate graphed test results.
5. **Hover Information:** lists minimum, first quartile, median, third quartile, and maximum. If either type of outlier is present the whisker on the appropriate side is taken to  $1.5 \times \text{IQR}$  from the quartile (the “inner fence”) rather than the max or min, and individual outlying data points are displayed as unfilled circles (for suspected outliers) or filled circles (for outliers). (The “outer fence” is  $3 \times \text{IQR}$  from the quartile.)

---

**Note:** Test results have been generated by [FD.io test executor vpp performance job 3n-hsw](#)<sup>39</sup>, [FD.io test executor vpp performance job 3n-skx](#)<sup>40</sup> and [FD.io test executor vpp performance job 2n-skx](#)<sup>41</sup> with RF result files csit-vpp-perf-1901-\*.zip [archived here](#). Required per test case data set size is **10**, but for VPP tests the actual size varies per test case and is  $\leq 10$ .

---

---

<sup>39</sup> <https://jenkins.fd.io/view/csit/job/csit-vpp-perf-verify-1901-3n-hsw>

<sup>40</sup> <https://jenkins.fd.io/view/csit/job/csit-vpp-perf-verify-1901-3n-skx>

<sup>41</sup> <https://jenkins.fd.io/view/csit/job/csit-vpp-perf-verify-1901-2n-skx>

### 2.3.1 L2 Ethernet Switching

Following sections include summary graphs of VPP Phy-to-Phy performance with L2 Ethernet switching, including NDR throughput (zero packet loss) and PDR throughput (<0.5% packet loss). Performance is reported for VPP running in multiple configurations of VPP worker thread(s), a.k.a. VPP data plane thread(s), and their physical CPU core(s) placement.

CSIT source code for the test cases used for plots can be found in [CSIT git repository](#)<sup>42</sup>.

---

<sup>42</sup> <https://git.fd.io/csit/tree/tests/vpp/perf/l2?h=rls1901>

3n-hsw-x520

64b-1t1c-base\_and\_scale

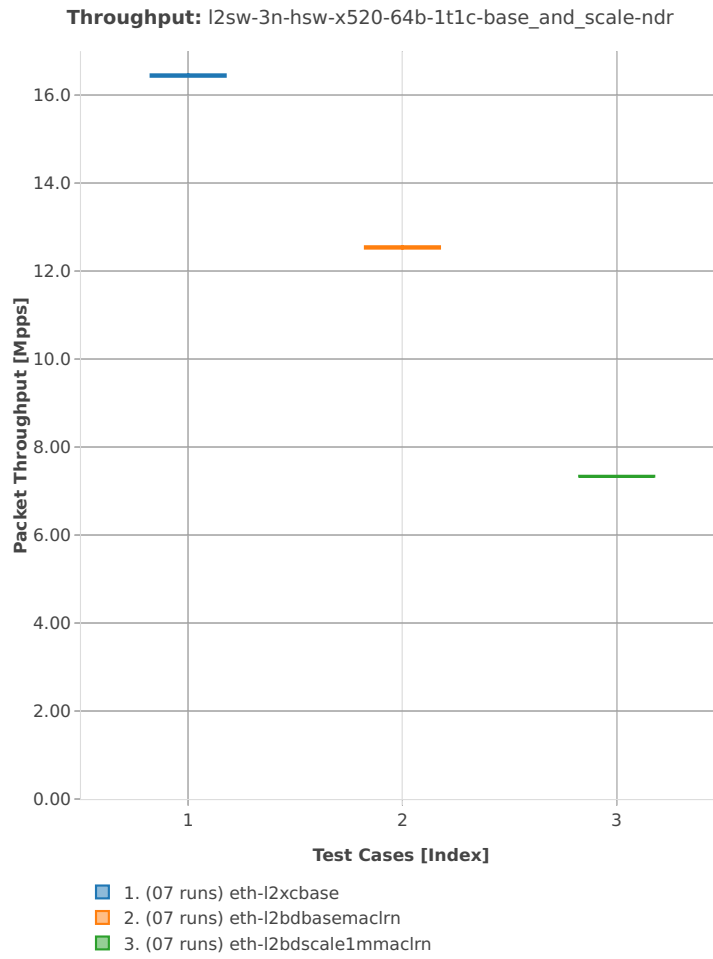

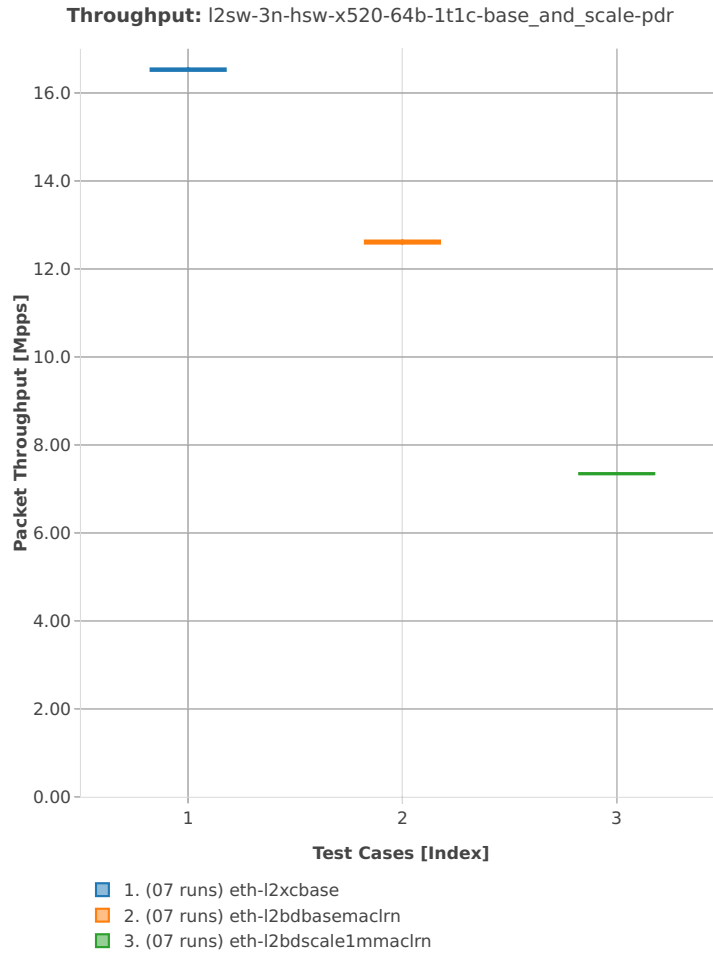

64b-2t2c-base\_and\_scale

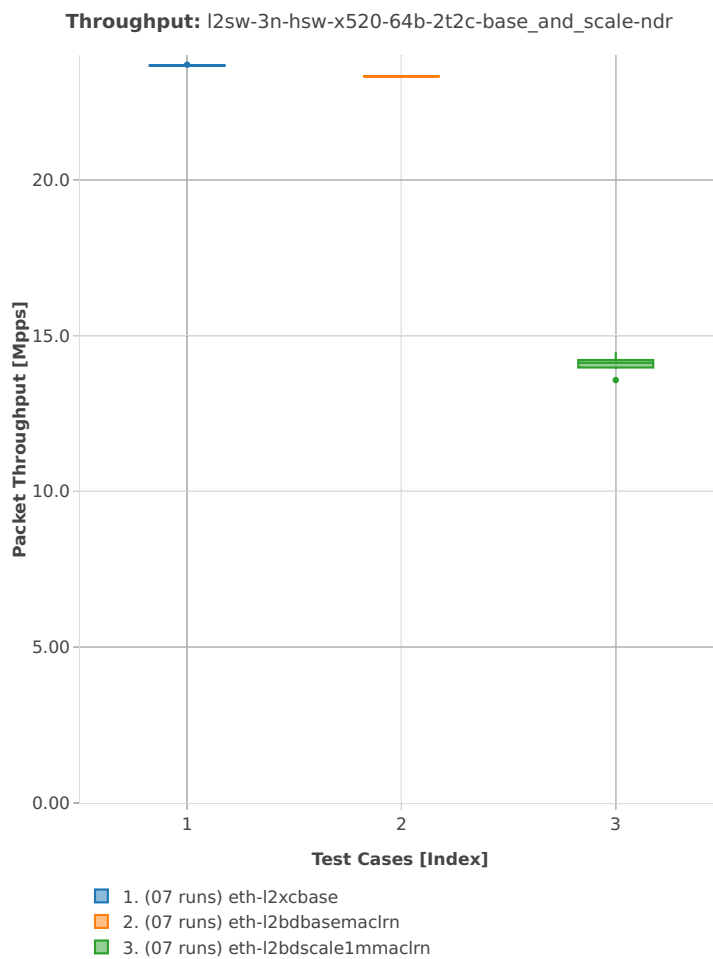

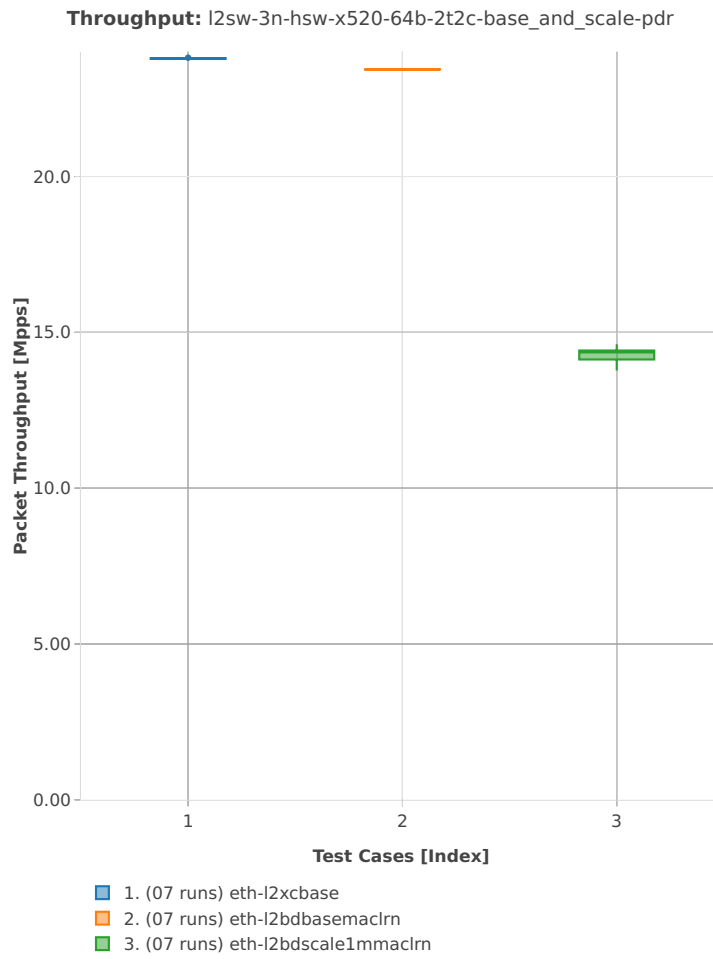



64b-1t1c-features

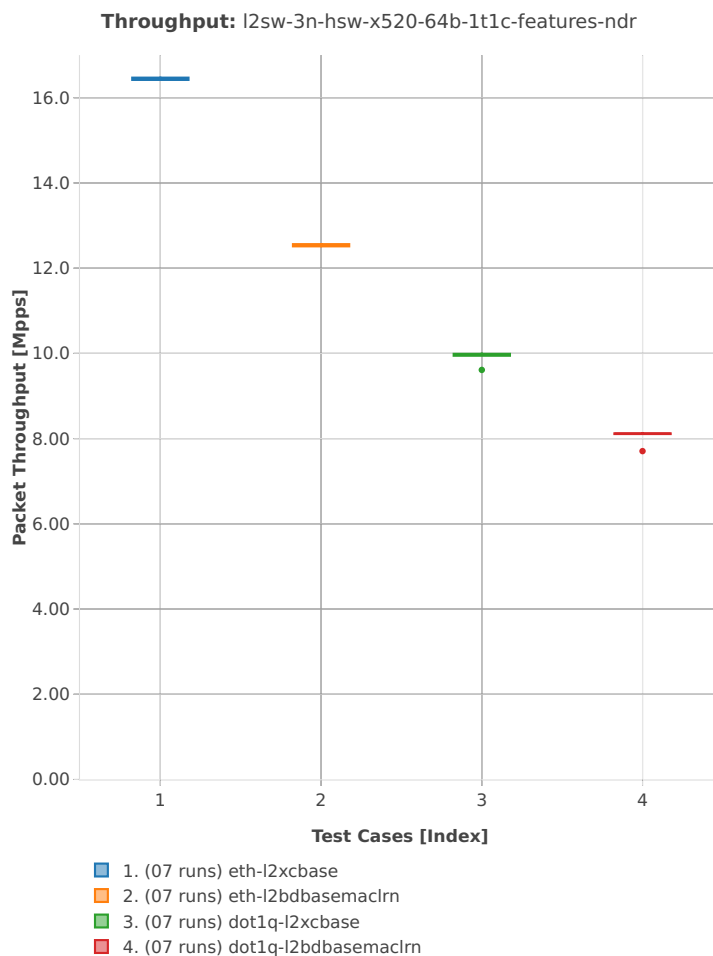

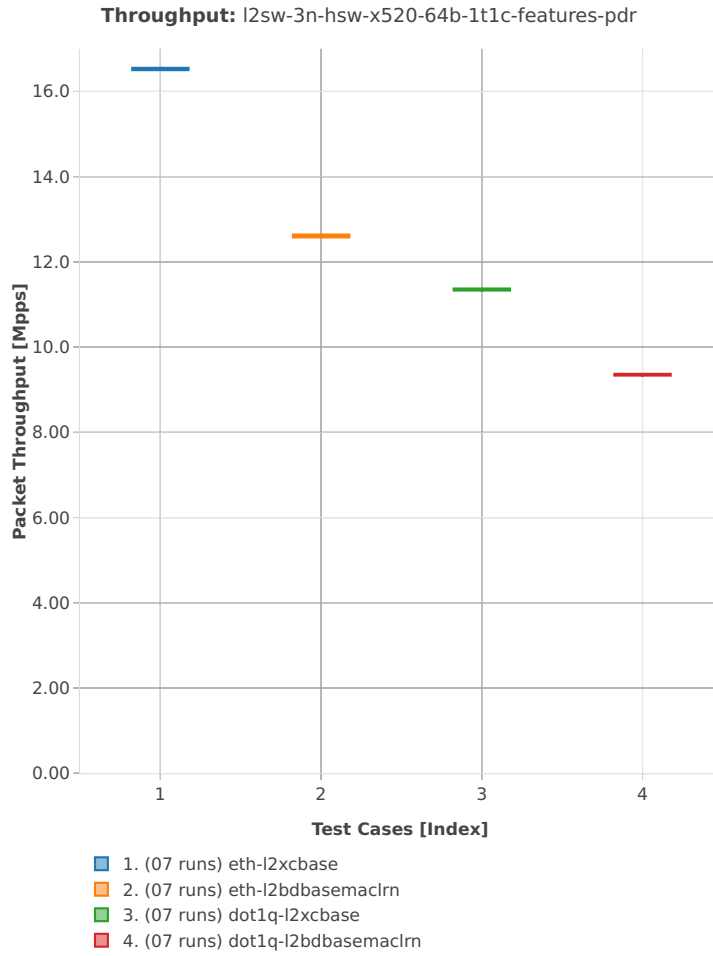

64b-2t2c-features

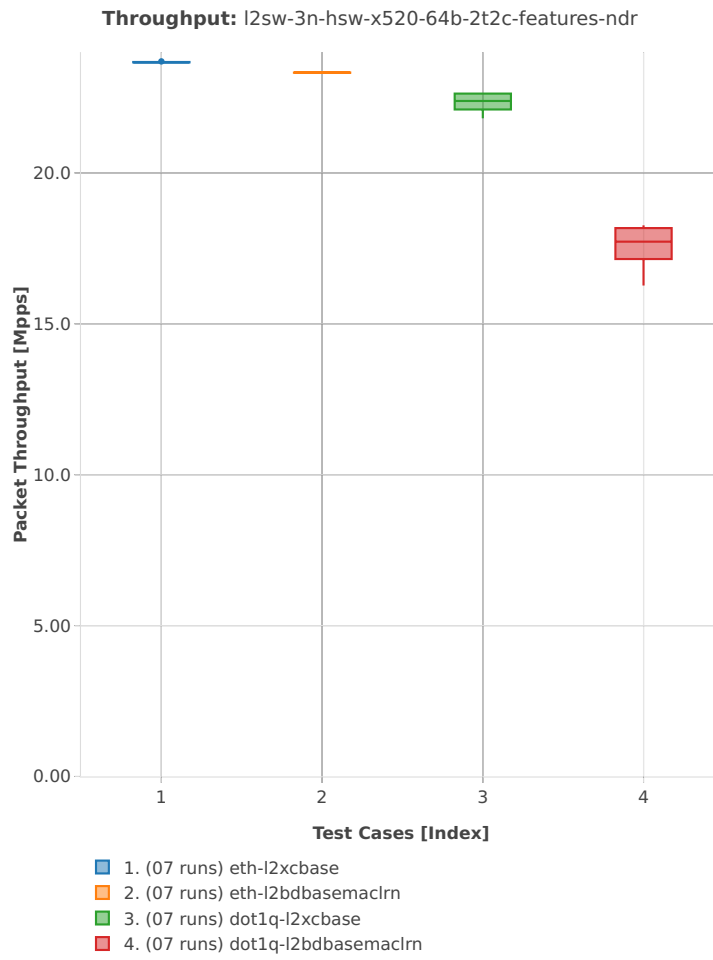

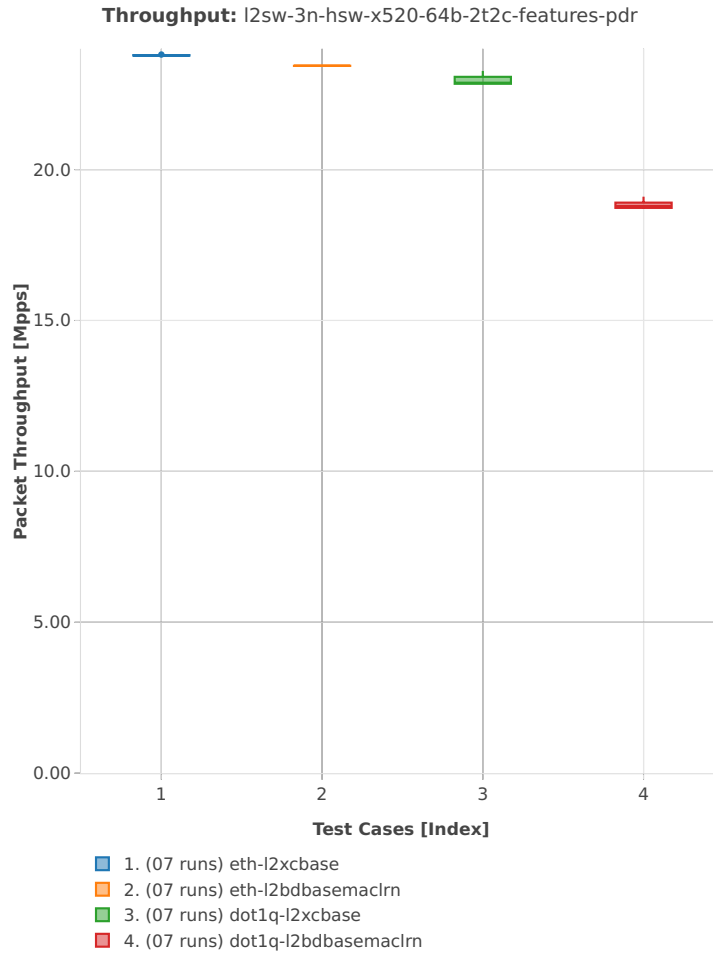

3n-hsw-x710

64b-1t1c-base\_and\_scale

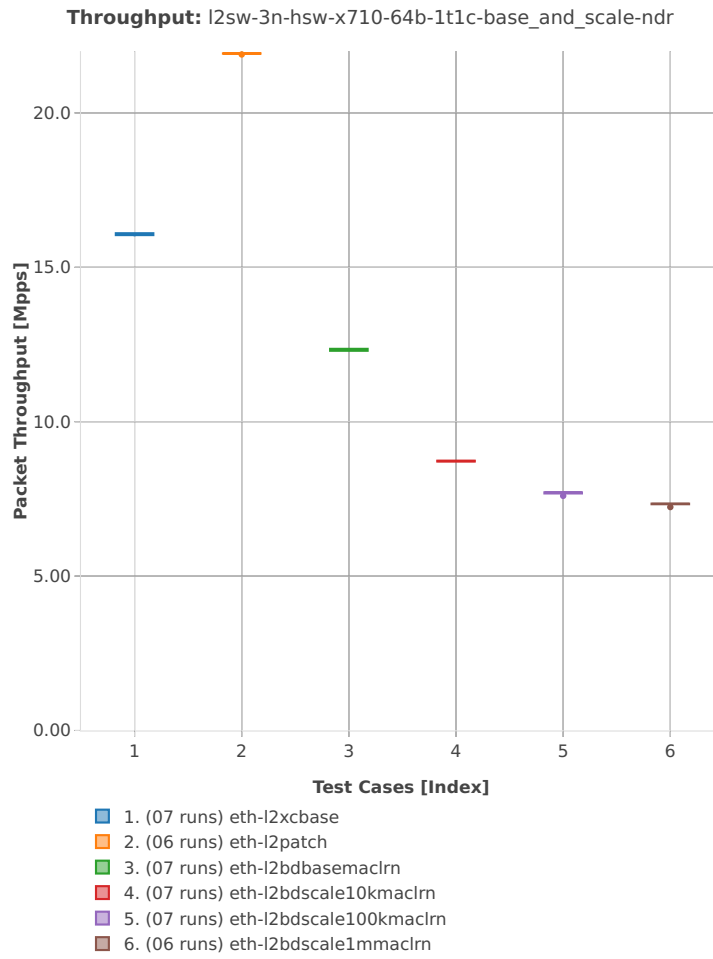

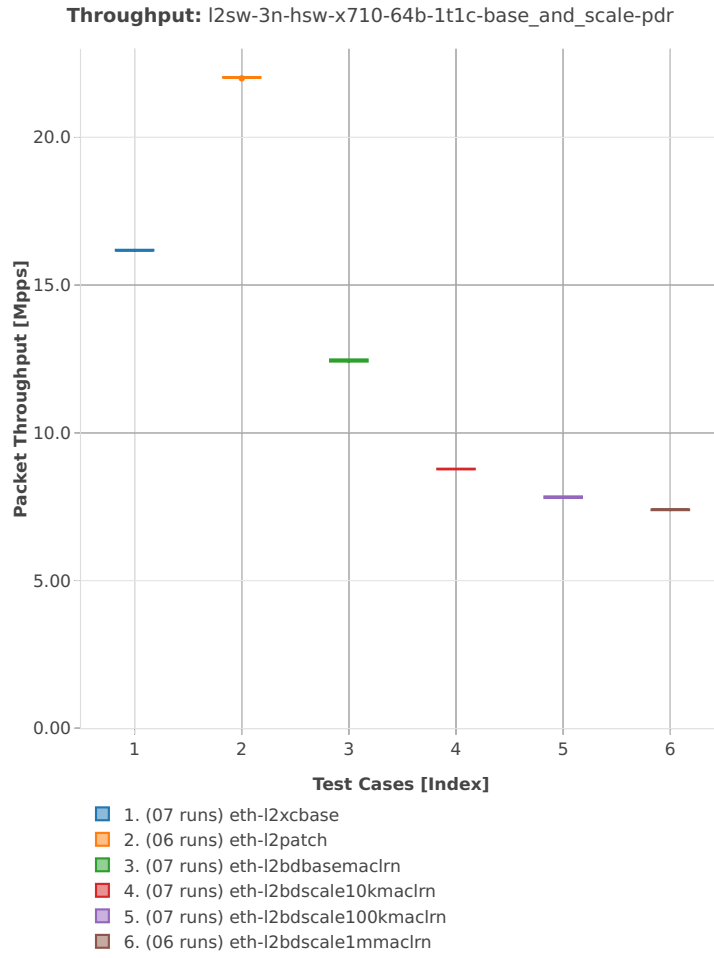

64b-2t2c-base\_and\_scale

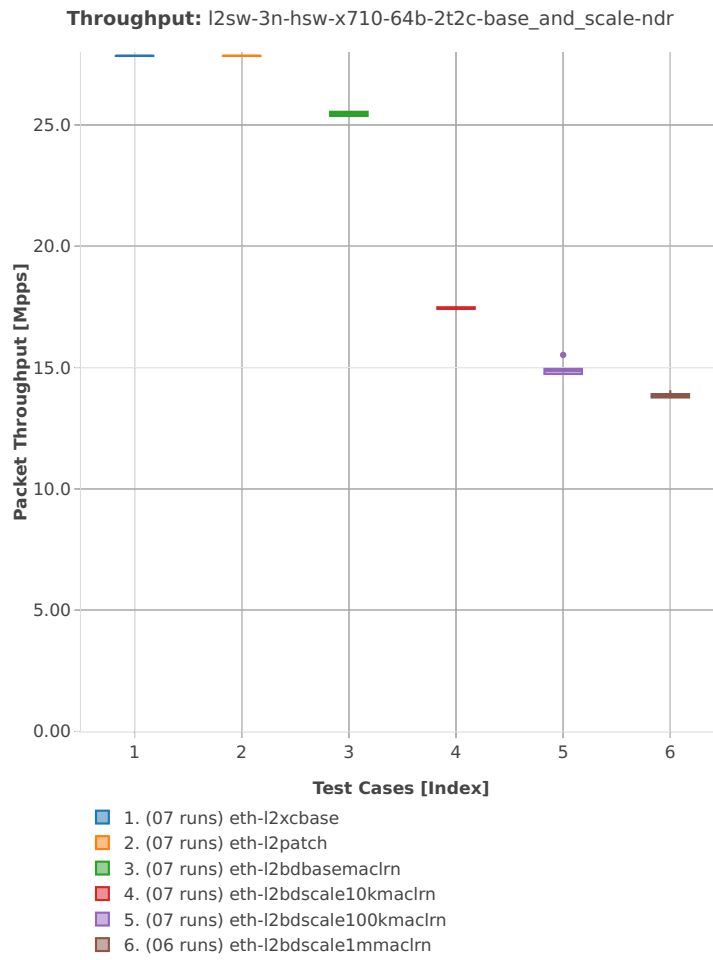

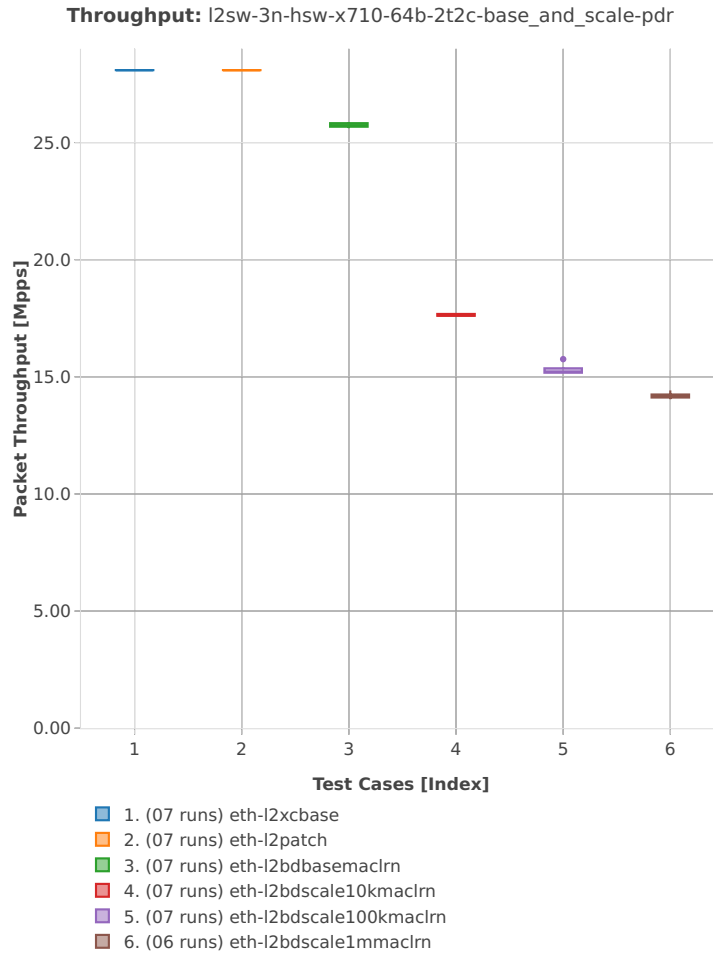



64b-1t1c-features

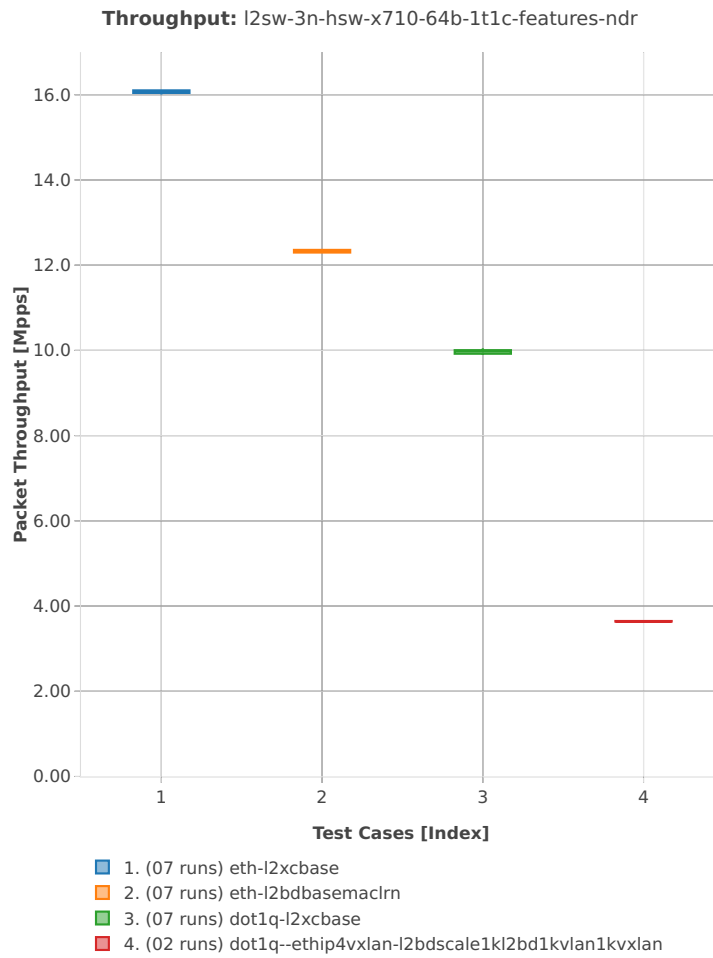

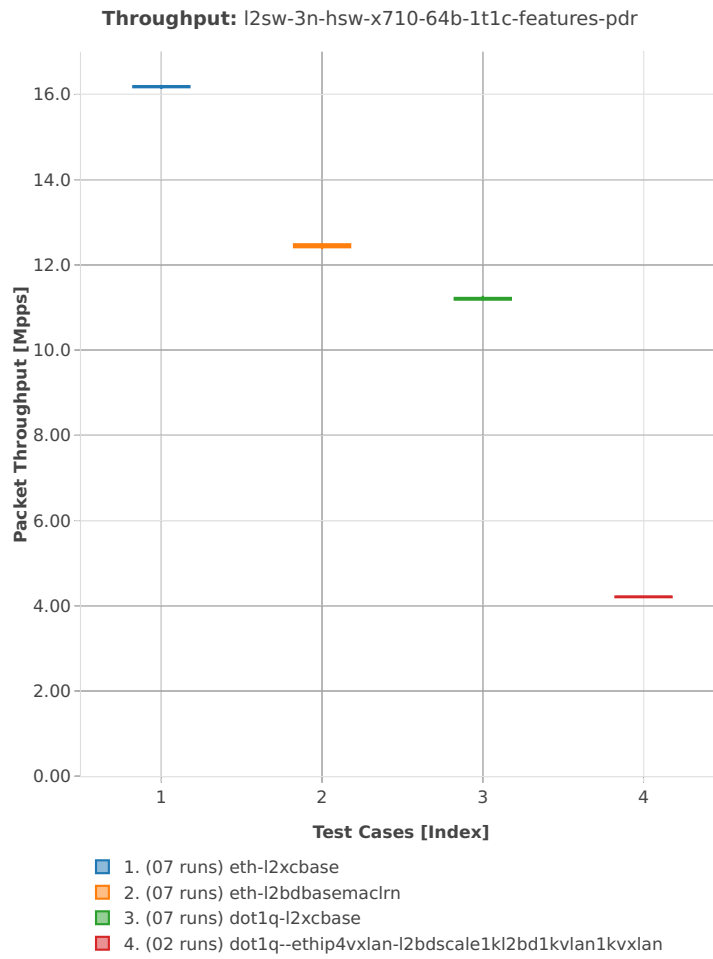

64b-2t2c-features

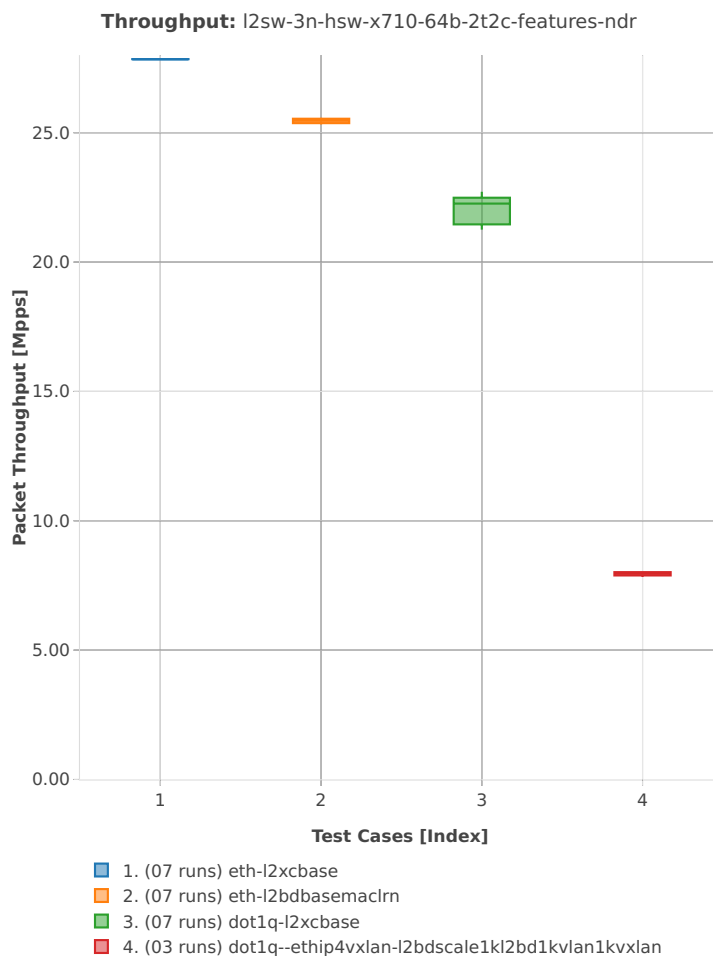

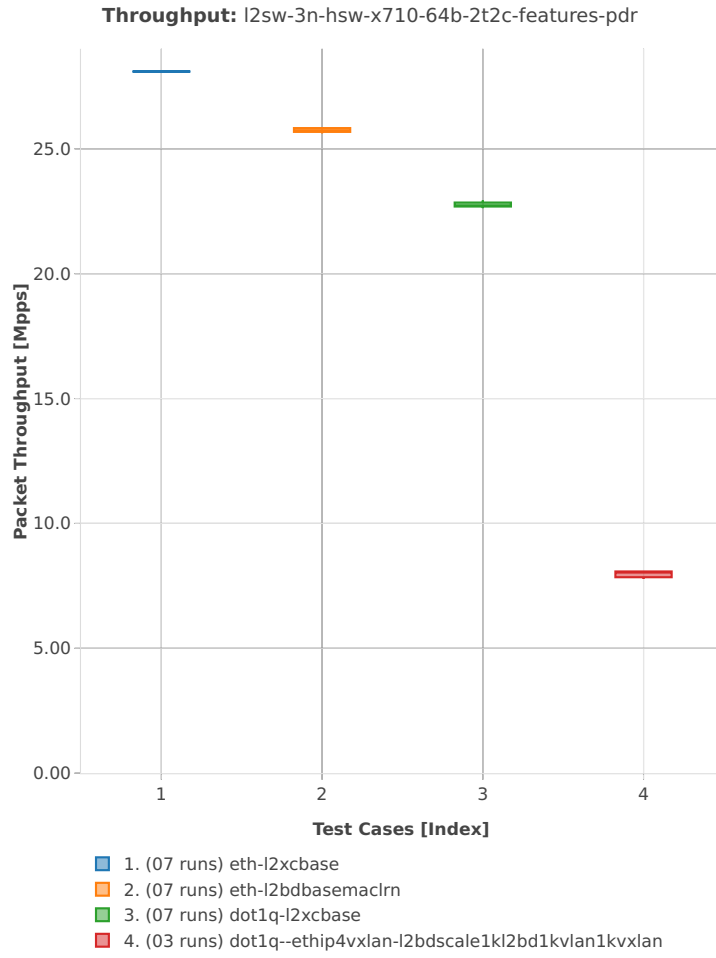

3n-hsw-xl710

64b-1t1c-base\_and\_scale

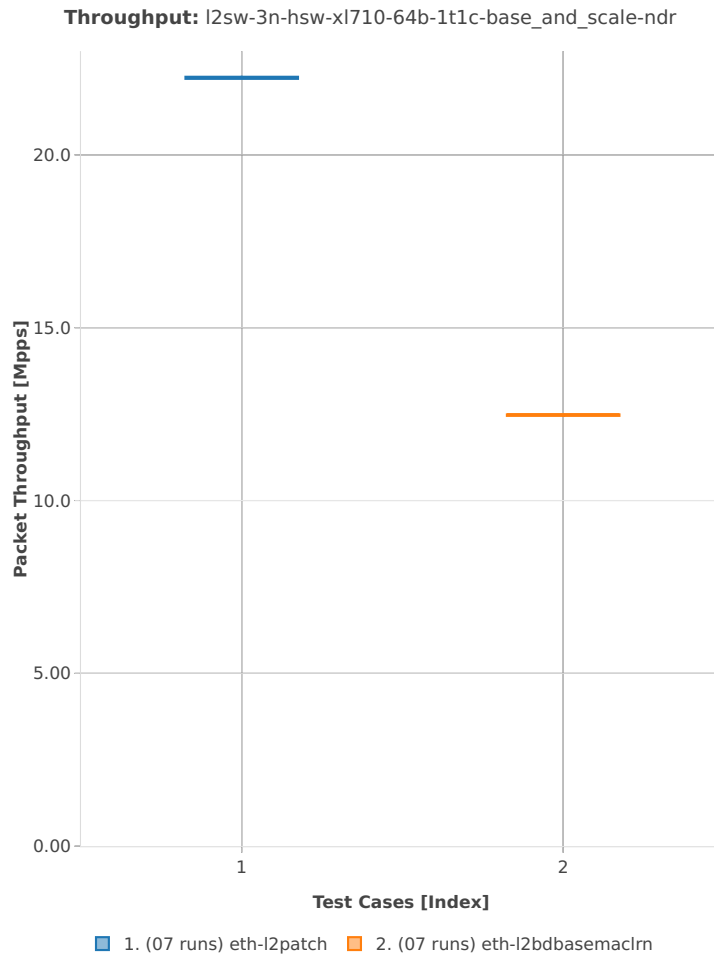

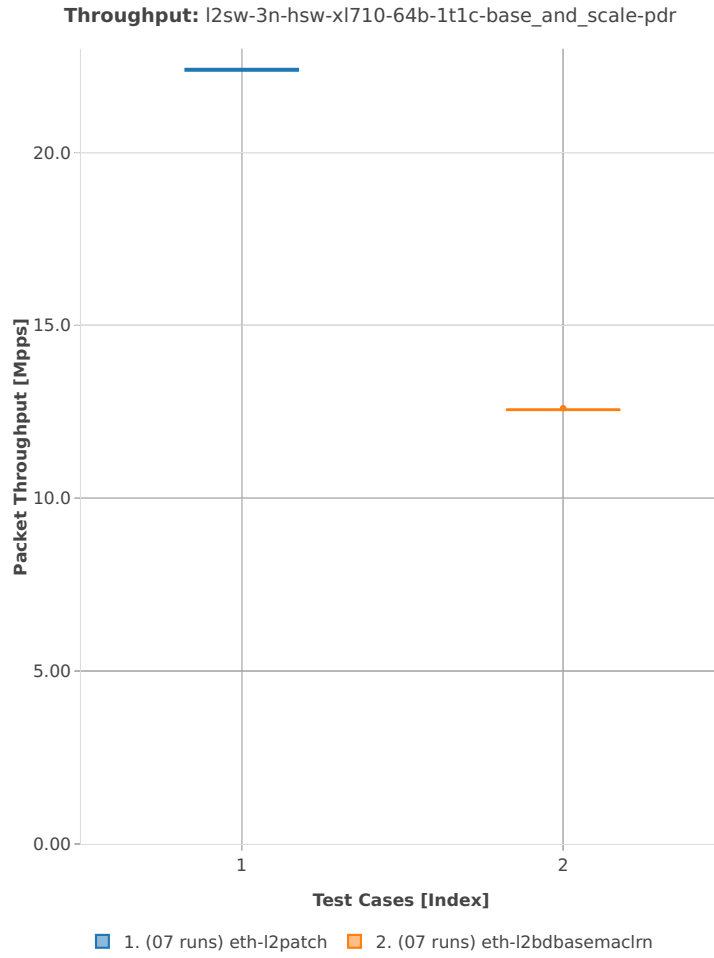

64b-2t2c-base\_and\_scale

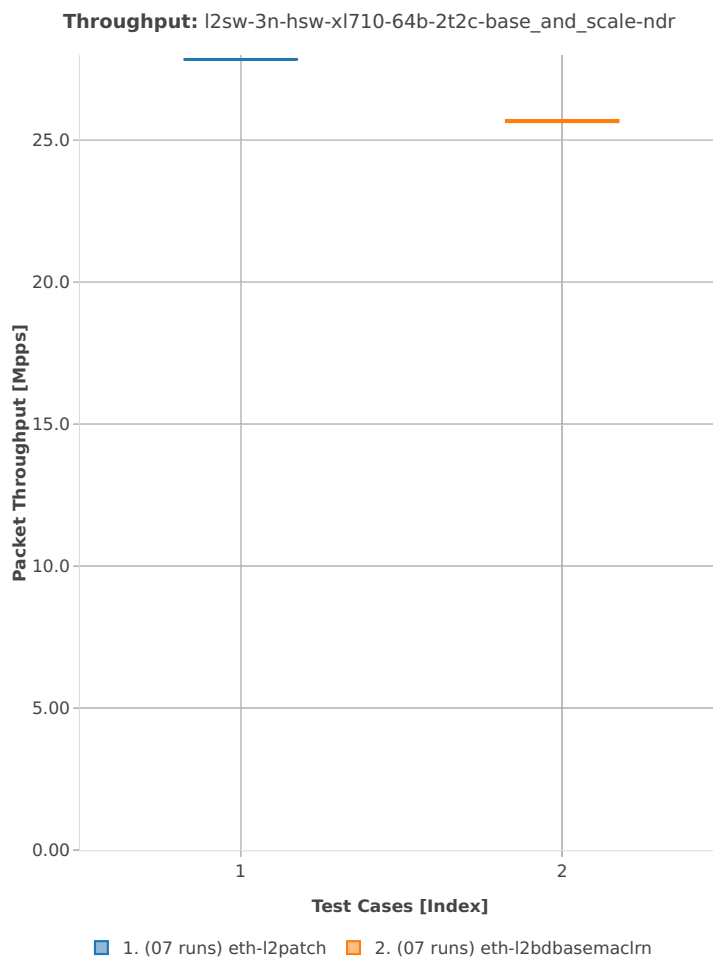

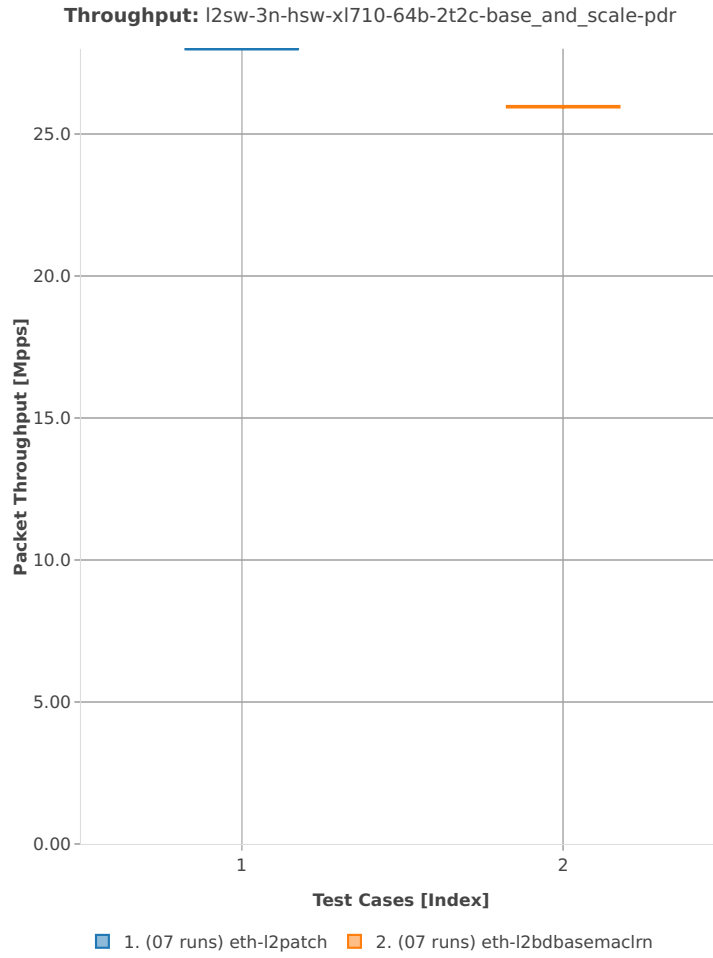



3n-skx-x710

64b-2t1c-base\_and\_scale

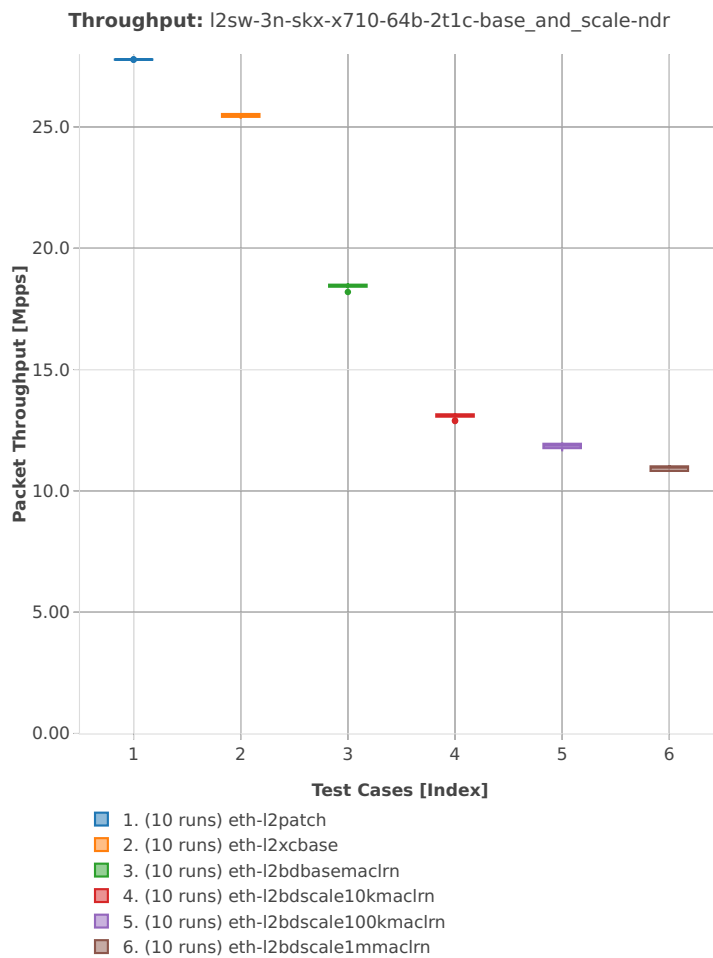

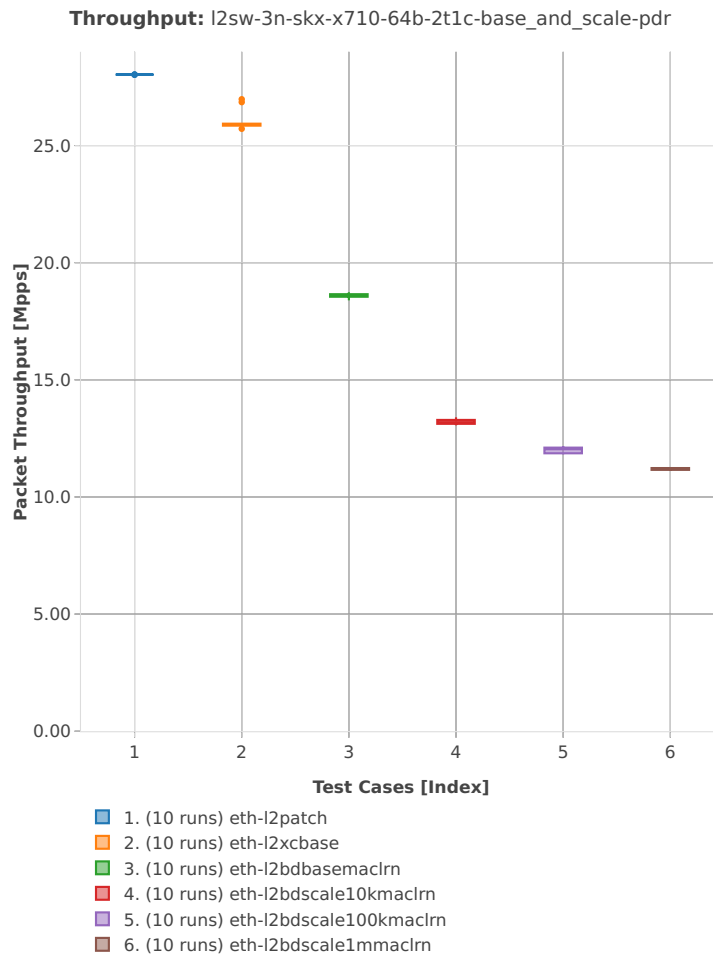

64b-4t2c-base\_and\_scale

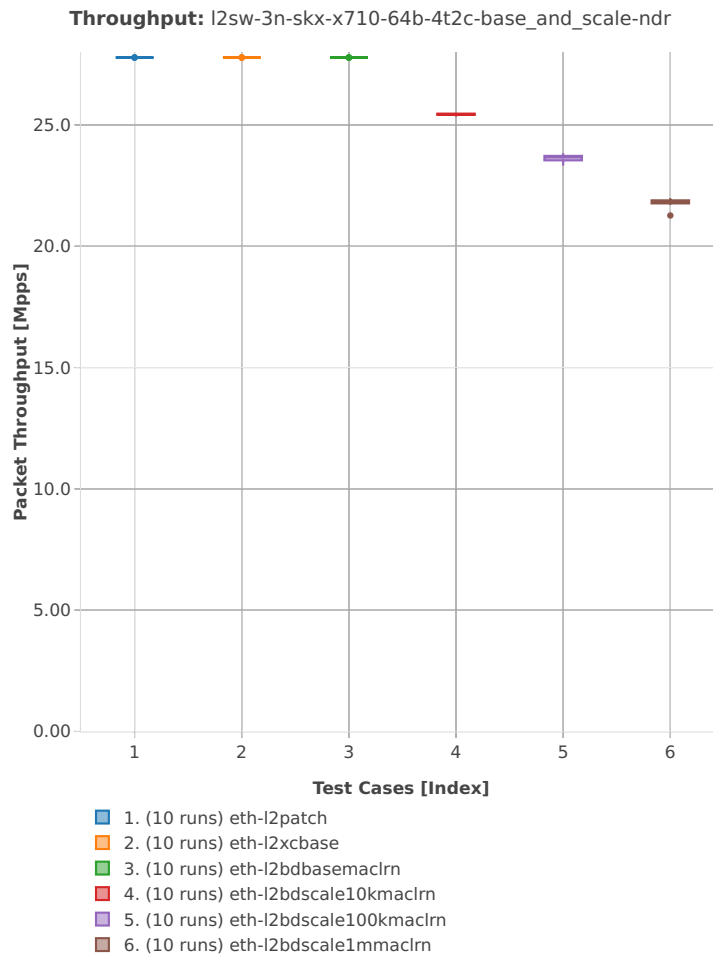

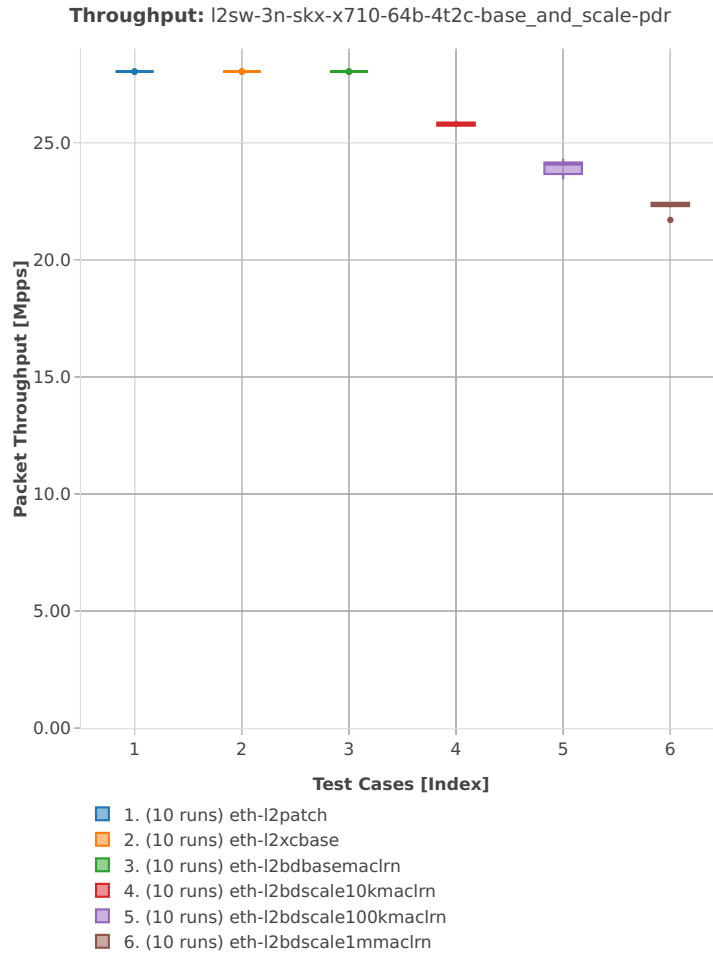

64b-2t1c-features

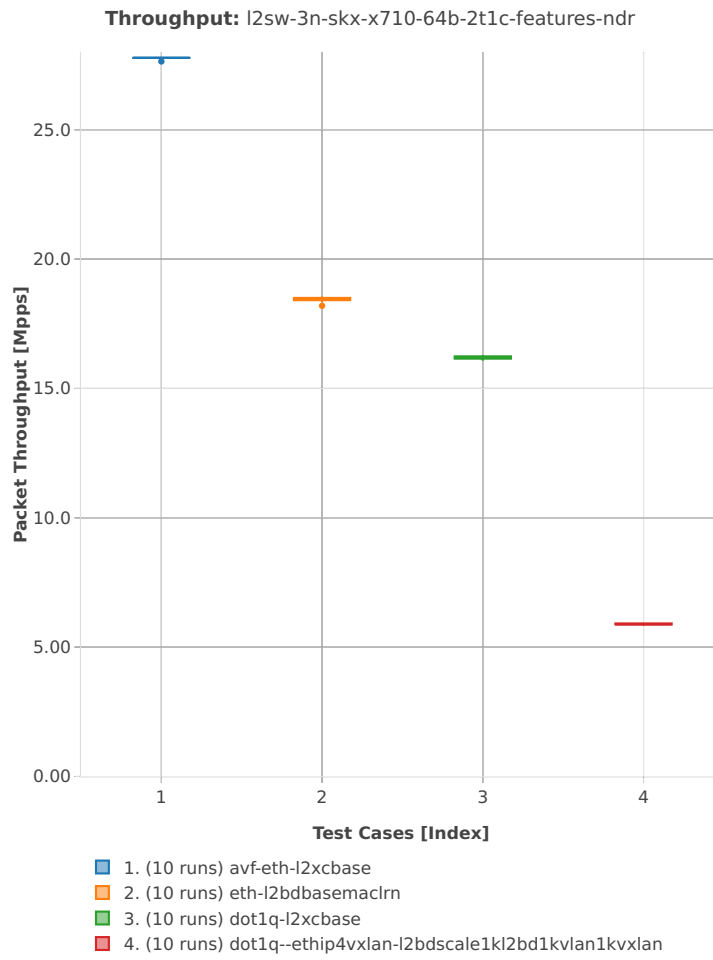

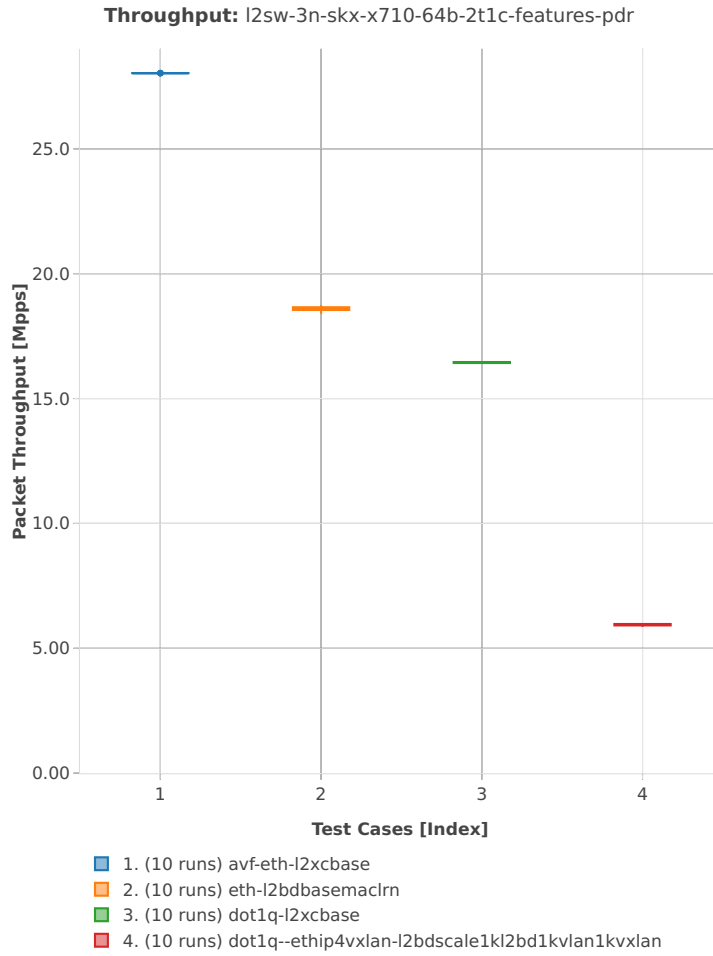

64b-4t2c-features

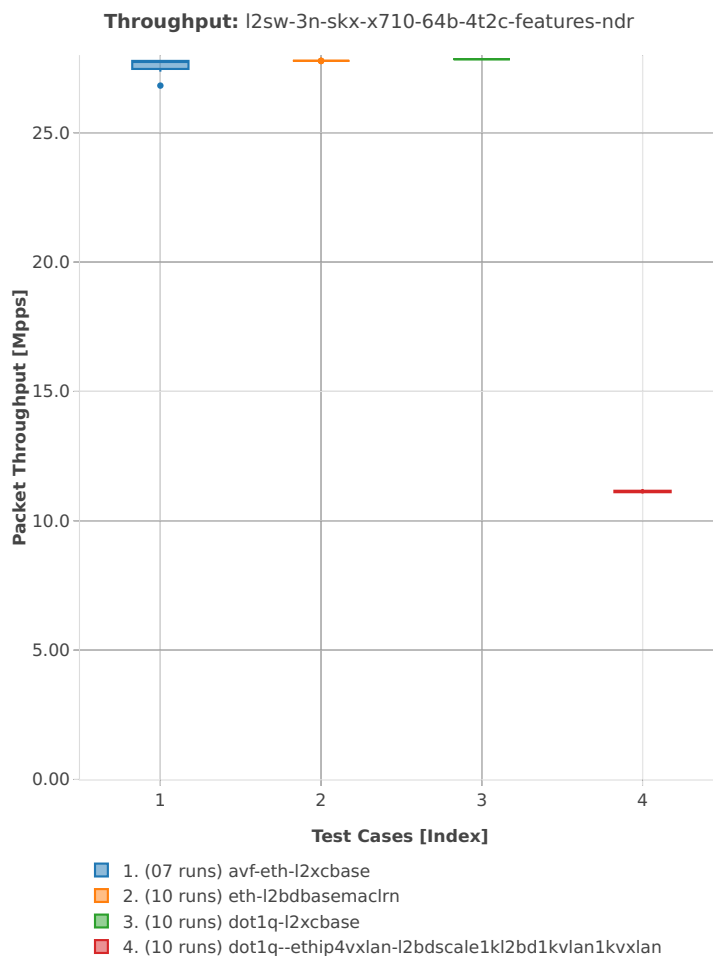

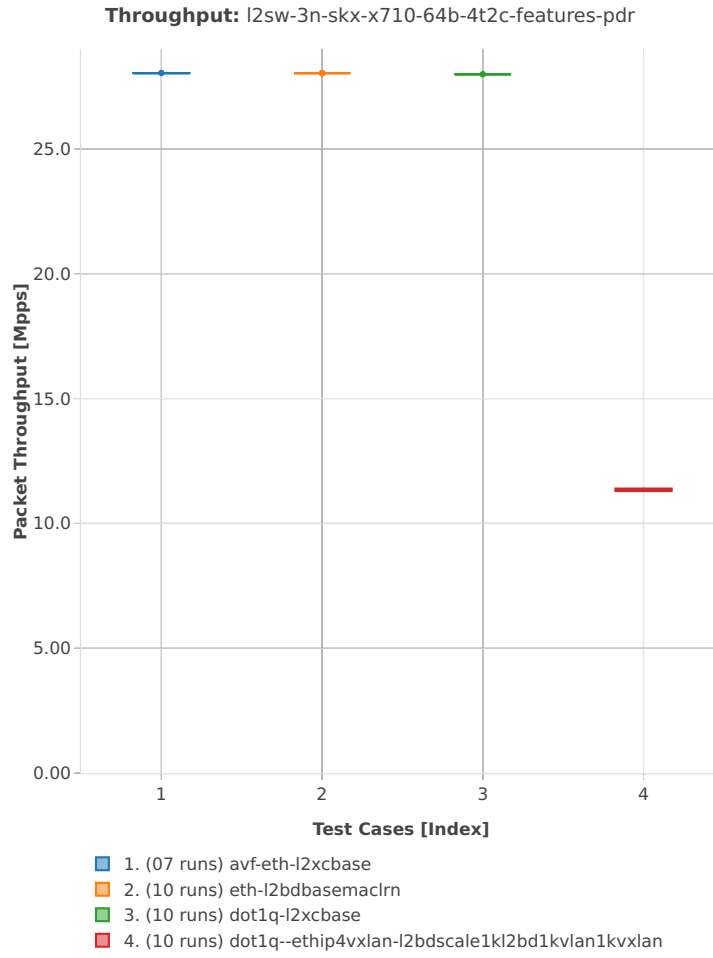



3n-skx-xxv710

64b-2t1c-base\_and\_scale

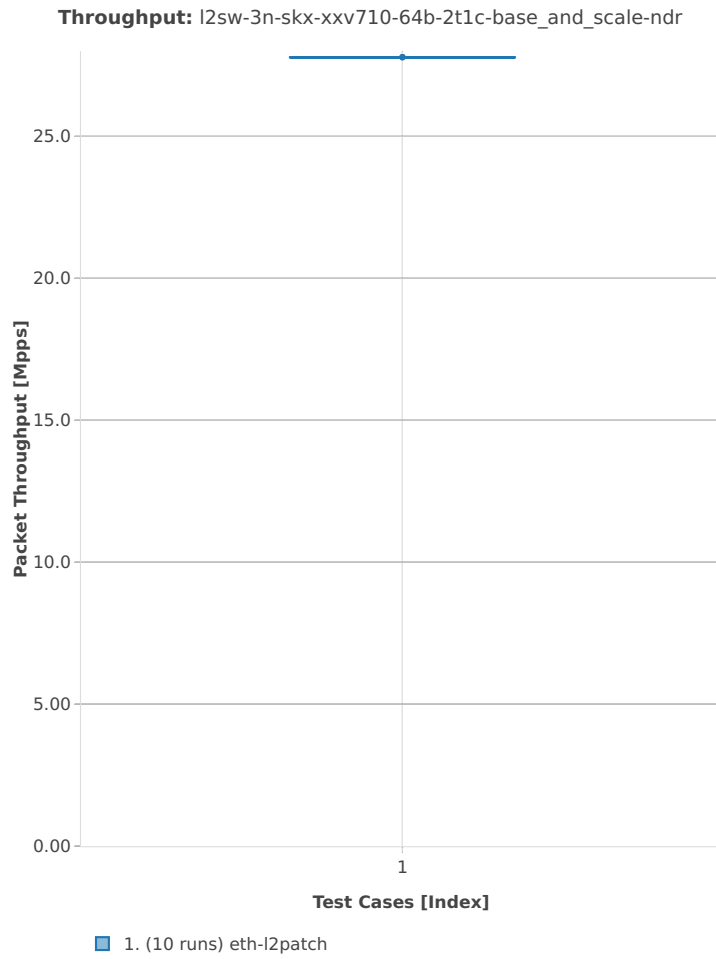

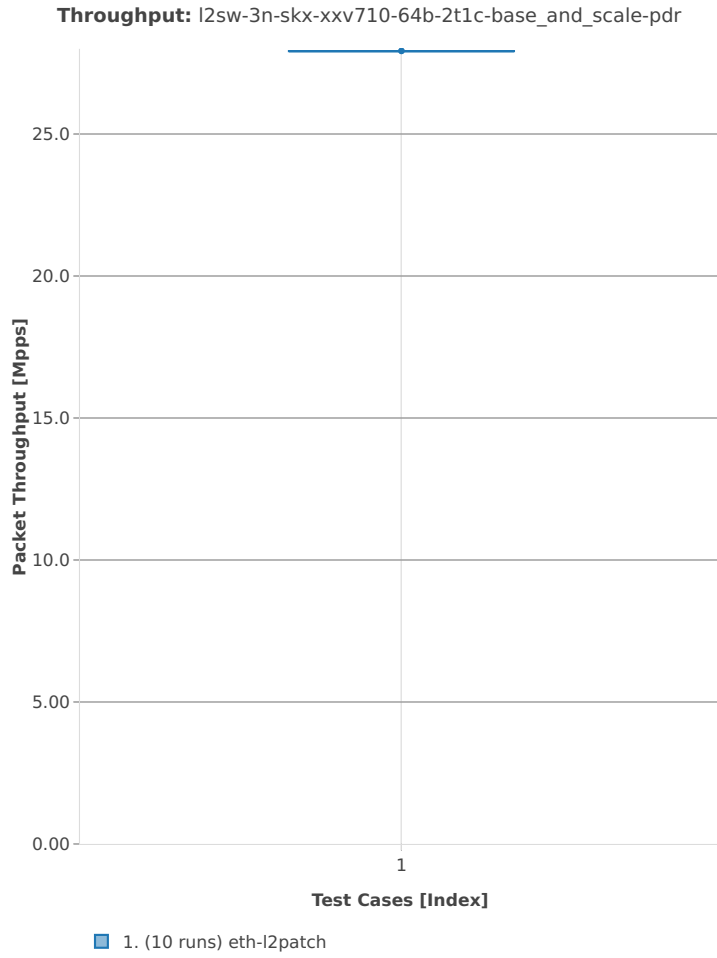

## 64b-4t2c-base\_and\_scale

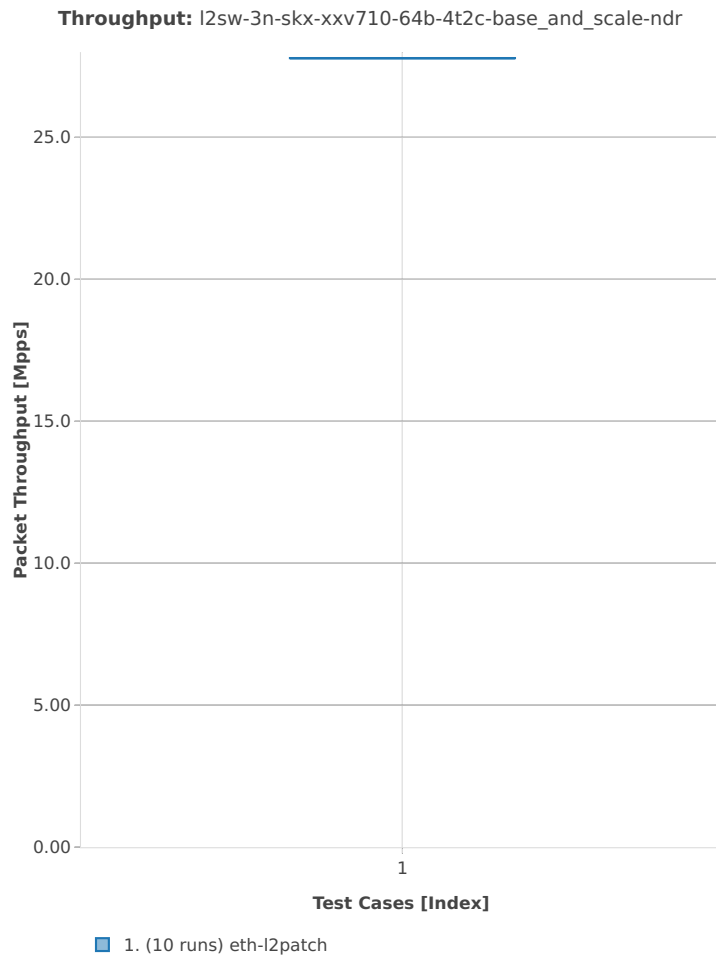

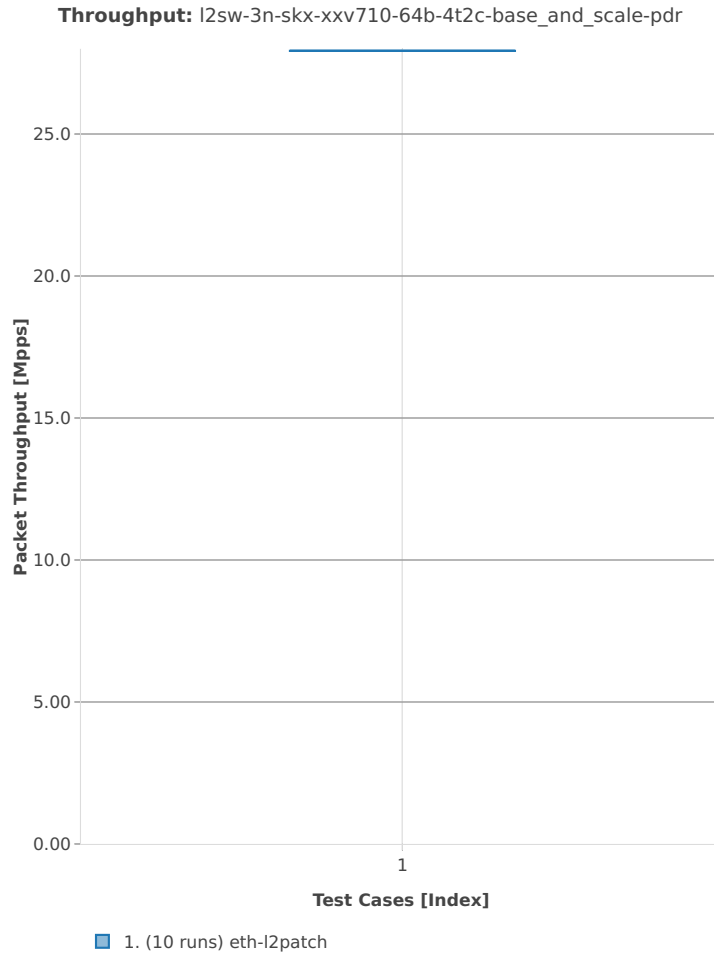

2n-skx-x710

64b-2t1c-base\_and\_scale

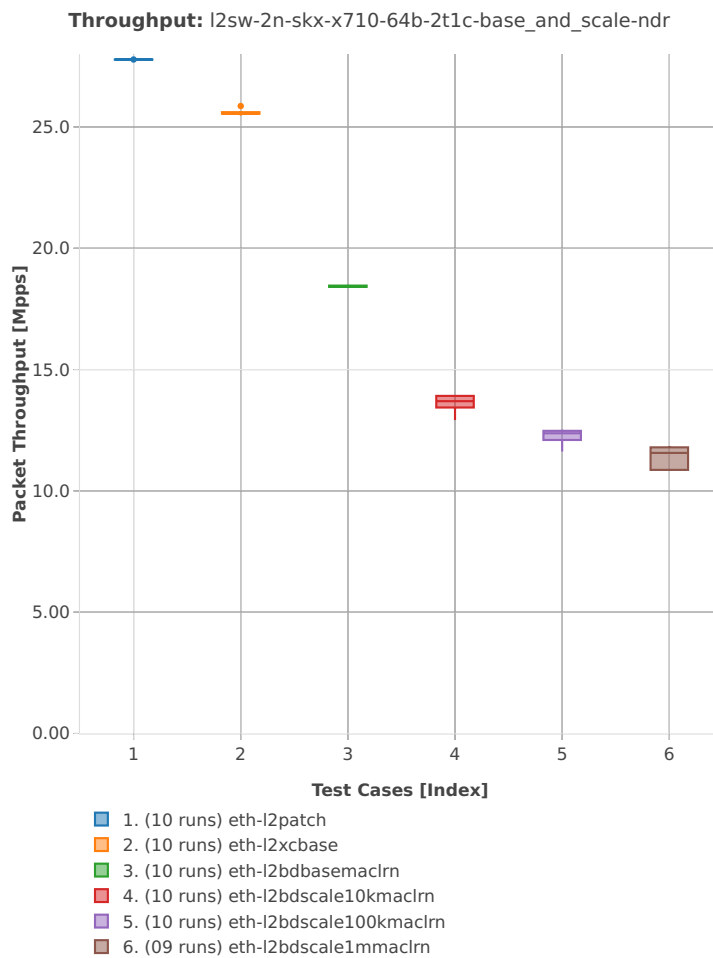

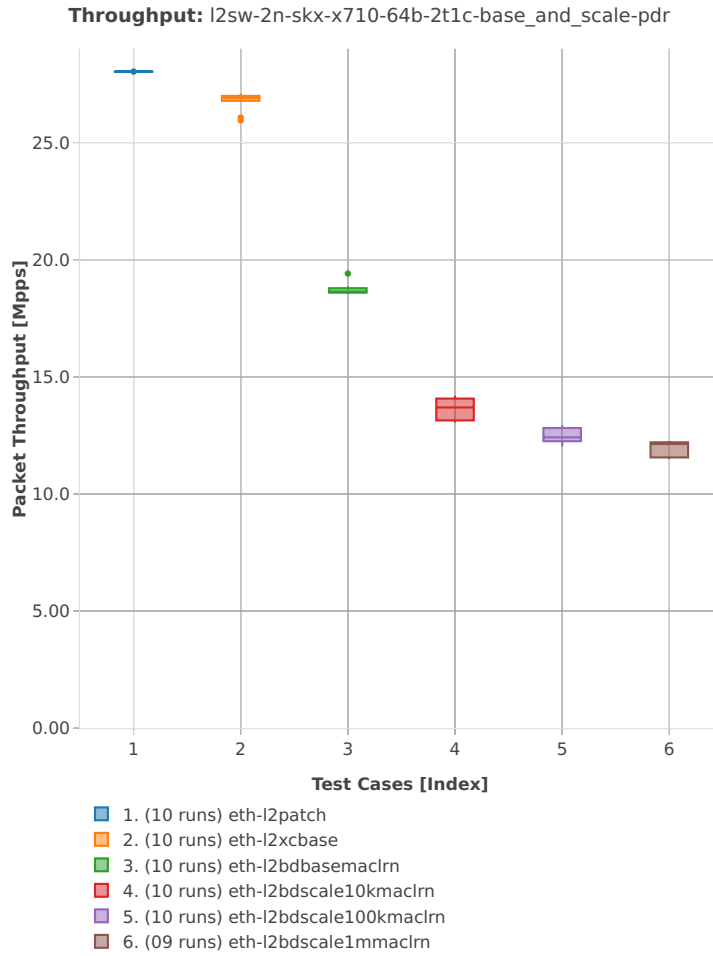

64b-4t2c-base\_and\_scale

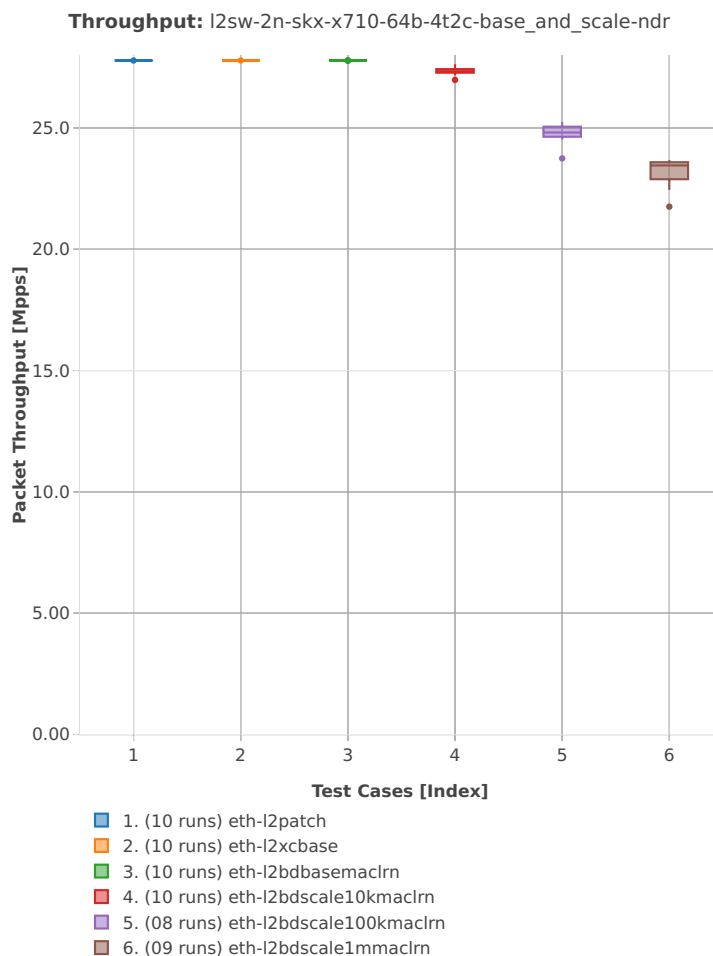

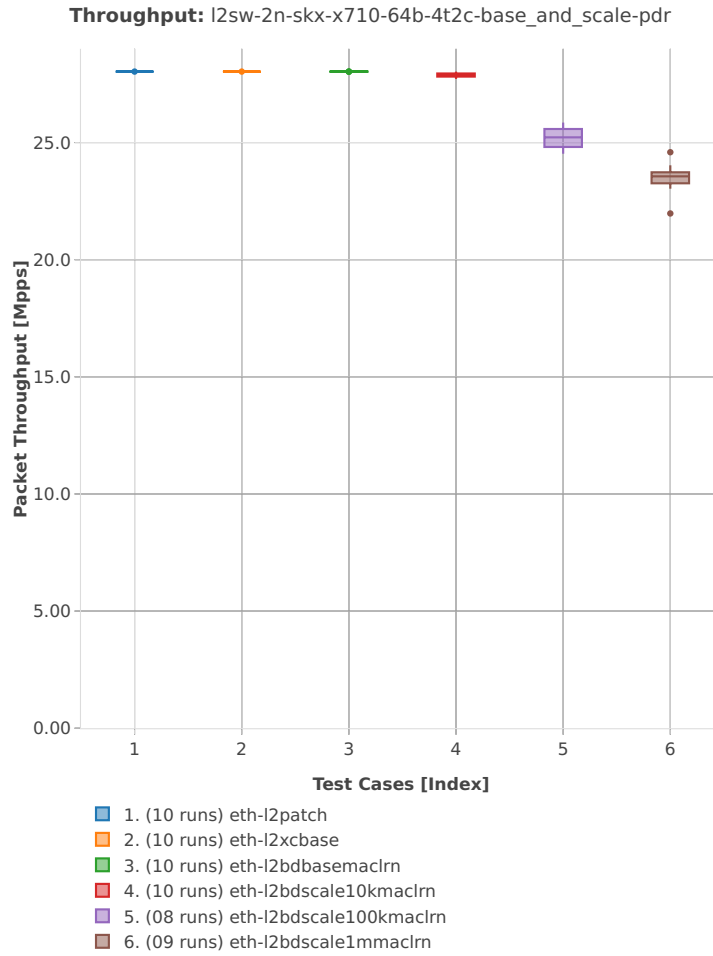



2n-skx-xxv710

64b-2t1c-base\_and\_scale

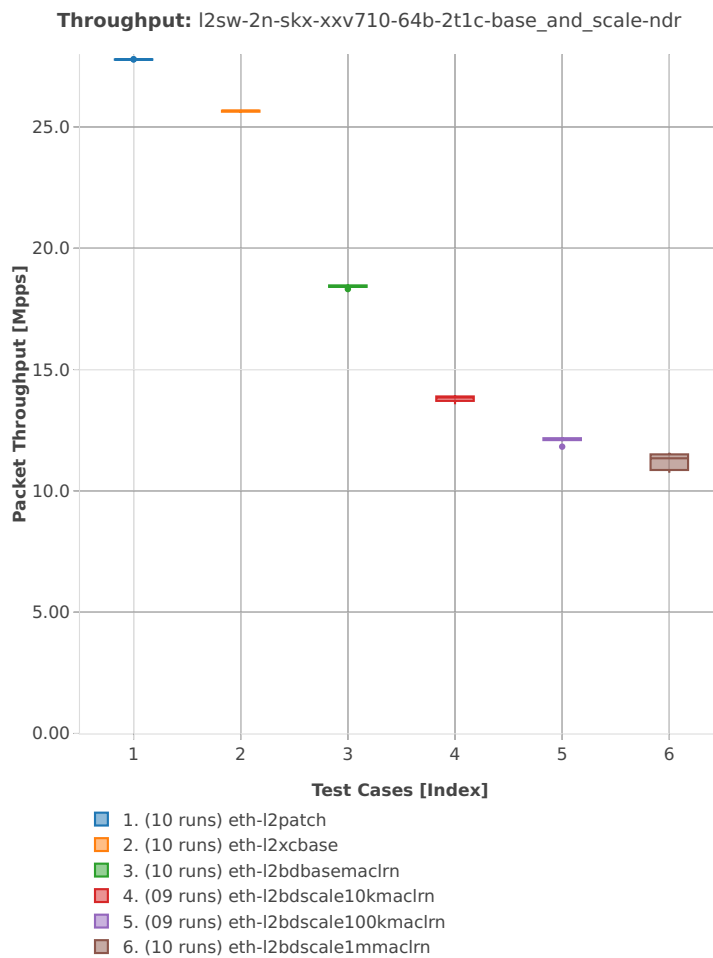

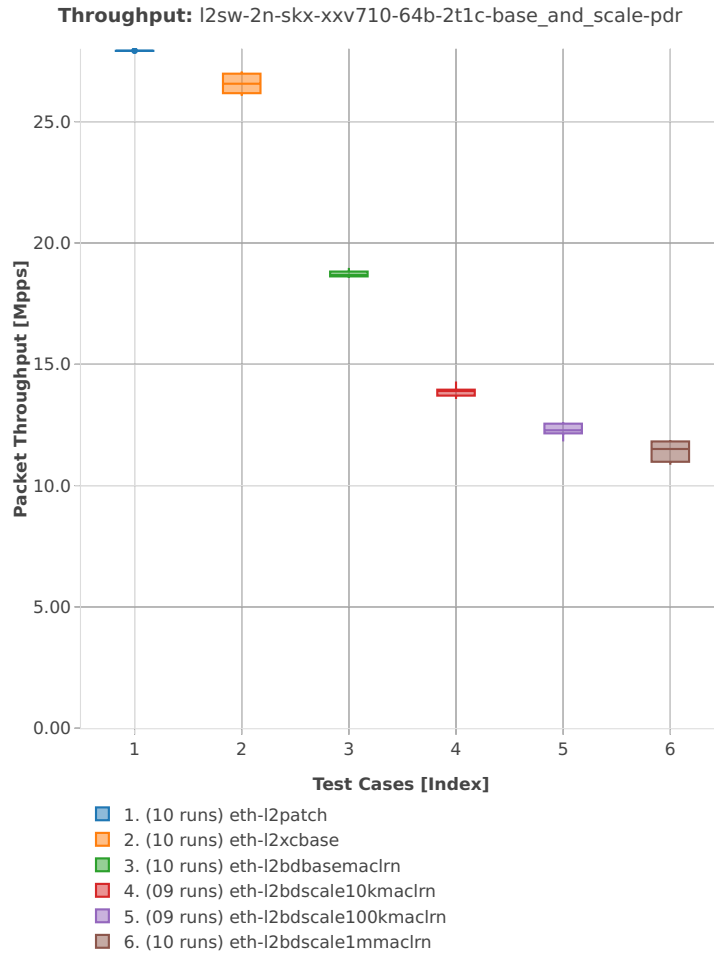

64b-4t2c-base\_and\_scale

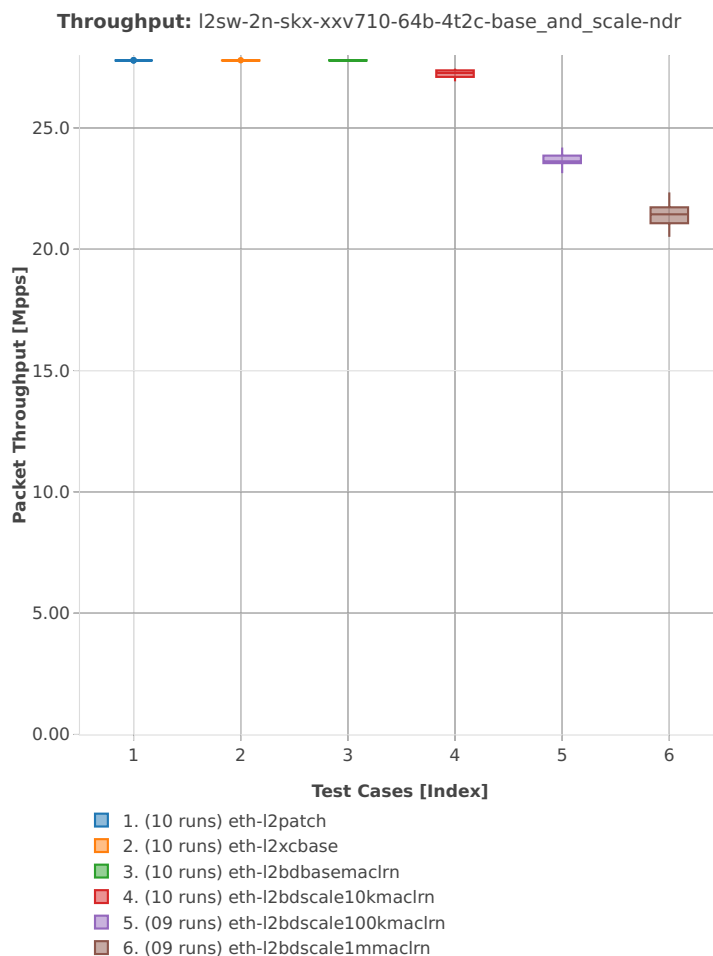

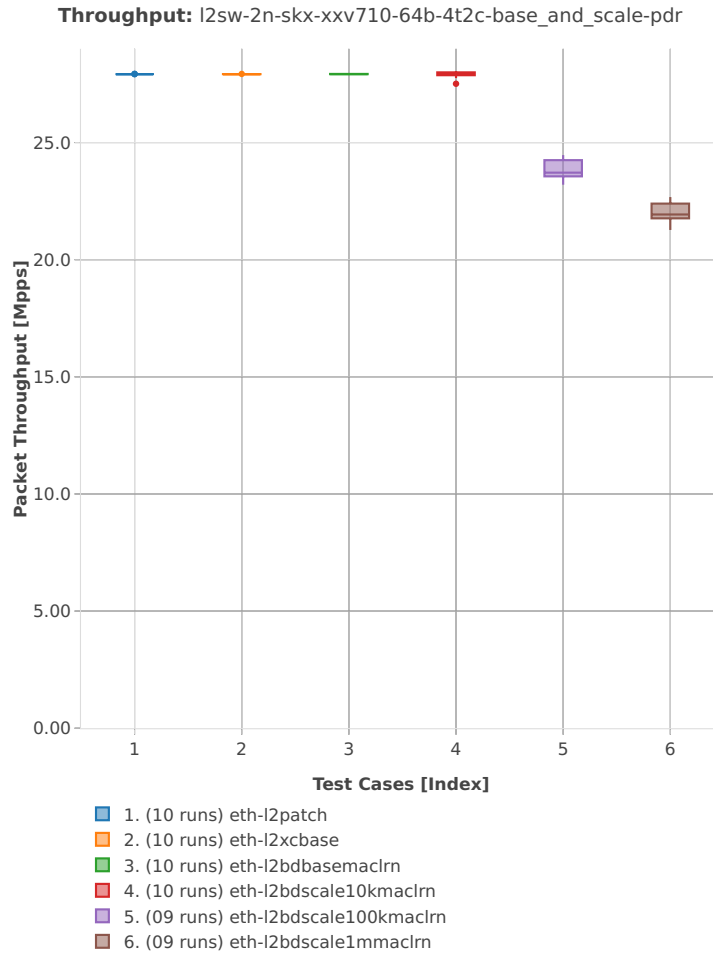

### 2.3.2 IPv4 Routing

Following sections include summary graphs of VPP Phy-to-Phy performance with IPv4 Routed-Forwarding, including NDR throughput (zero packet loss) and PDR throughput (<0.5% packet loss). Performance is reported for VPP running in multiple configurations of VPP worker thread(s), a.k.a. VPP data plane thread(s), and their physical CPU core(s) placement.

CSIT source code for the test cases used for plots can be found in [CSIT git repository](#)<sup>43</sup>.

---

<sup>43</sup> <https://git.fd.io/csit/tree/tests/vpp/perf/ip4?h=rls1901>

3n-hsw-x520

64b-1t1c-base\_and\_scale

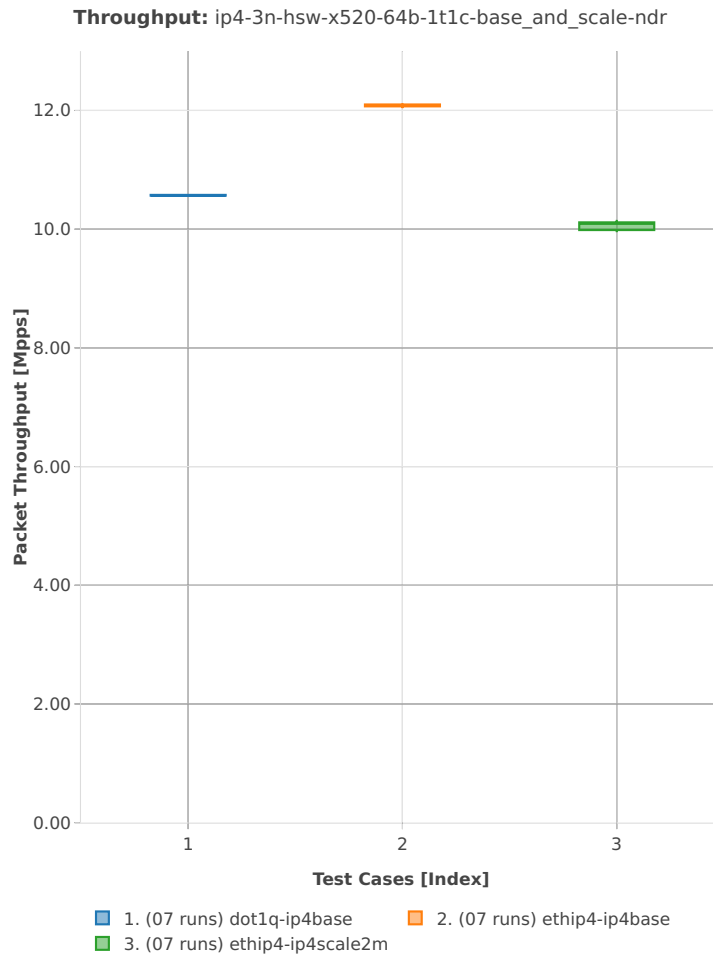

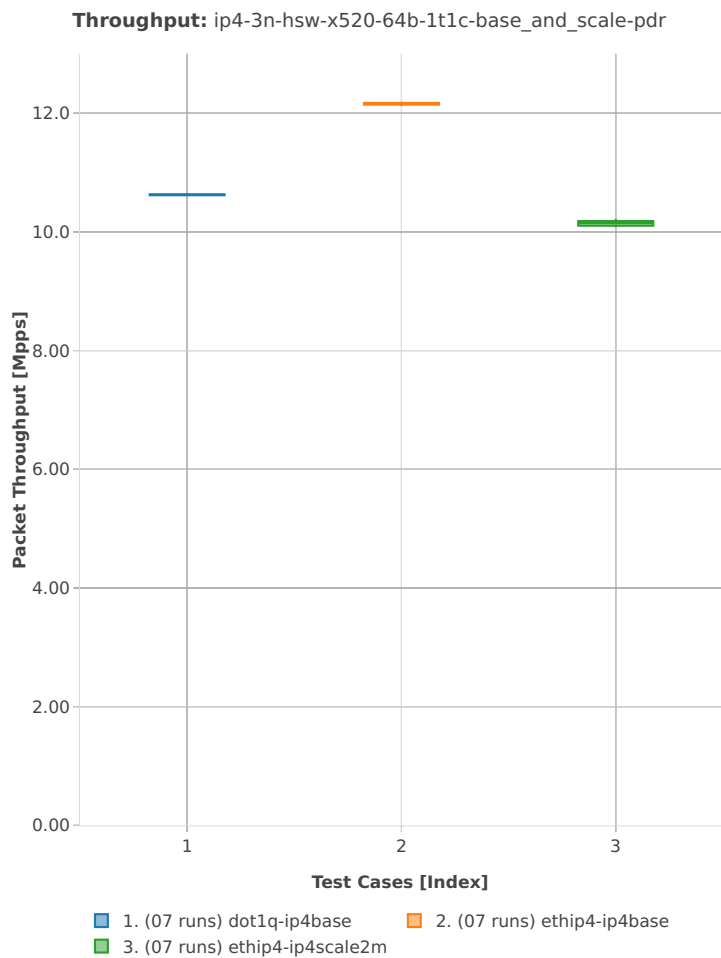

## 64b-2t2c-base\_and\_scale

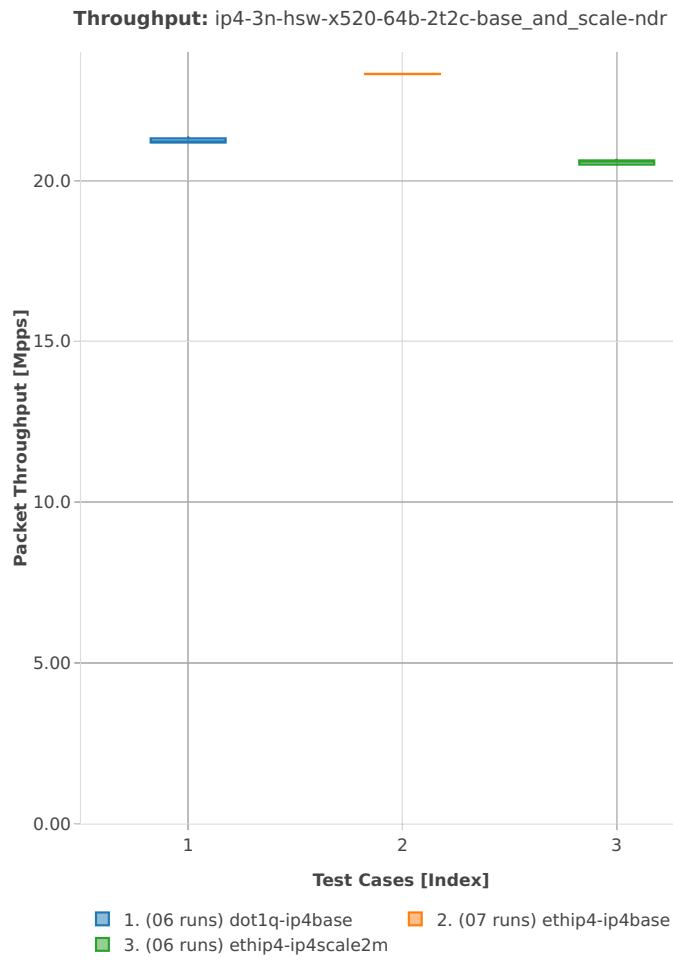



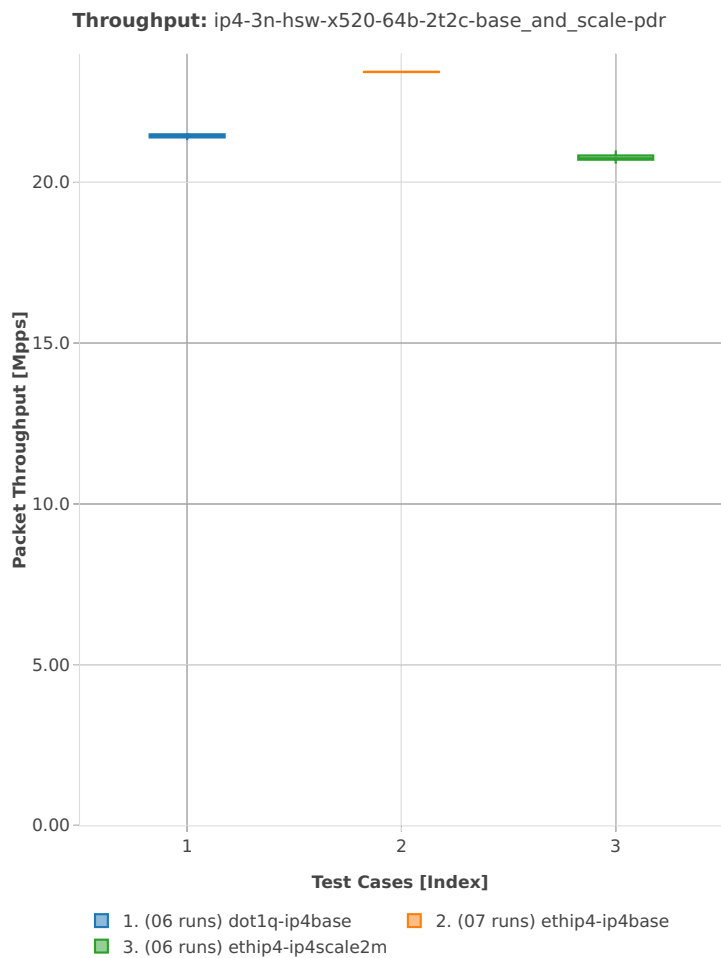

## 64b-1t1c-features

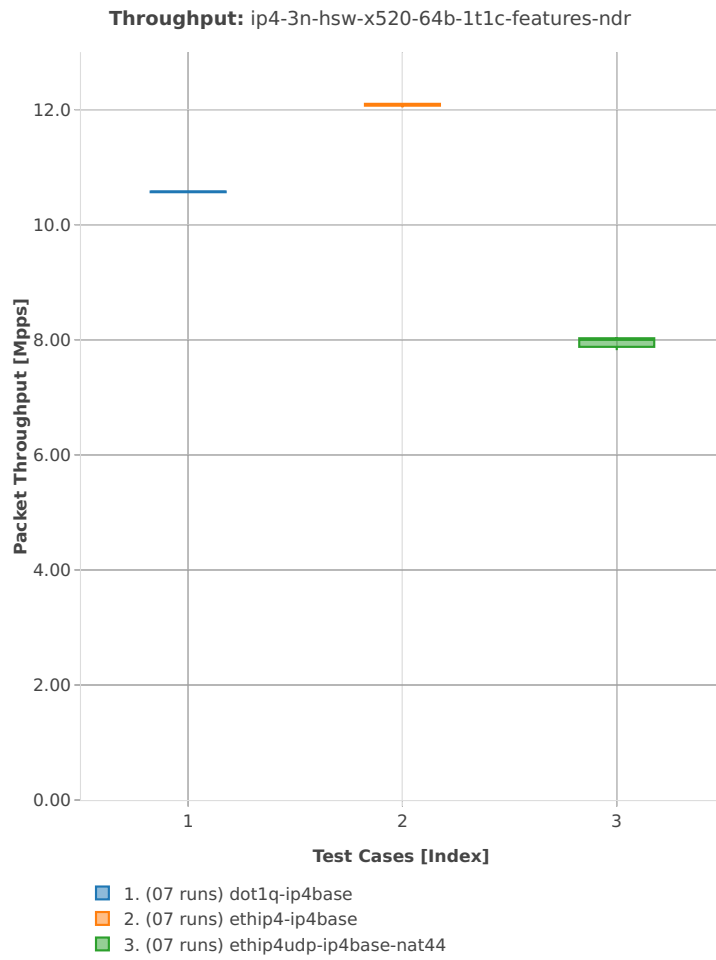

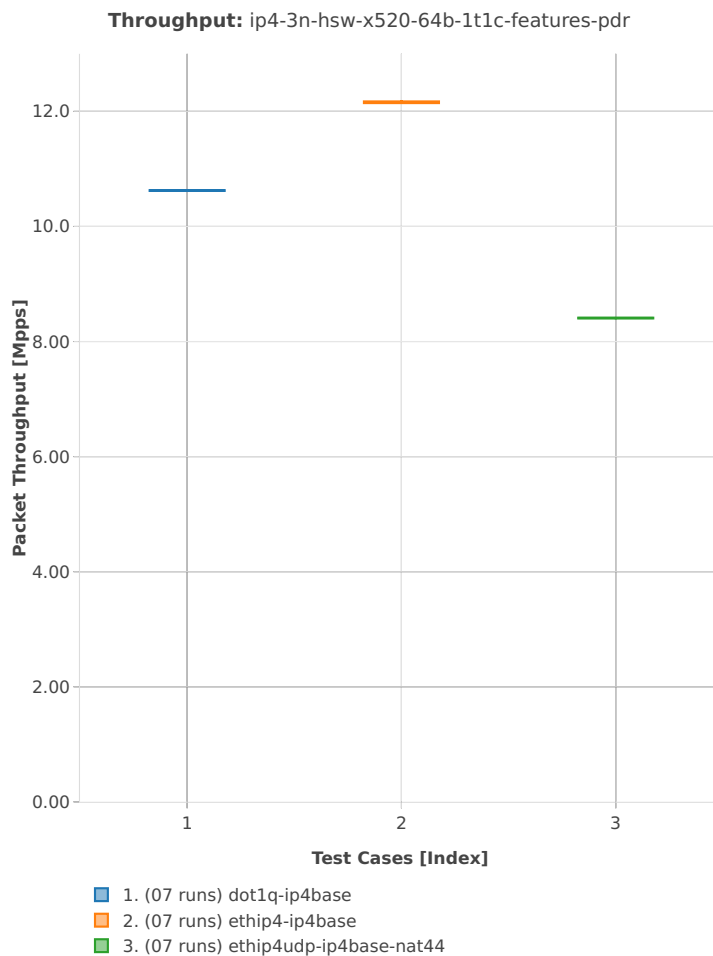

64b-2t2c-features

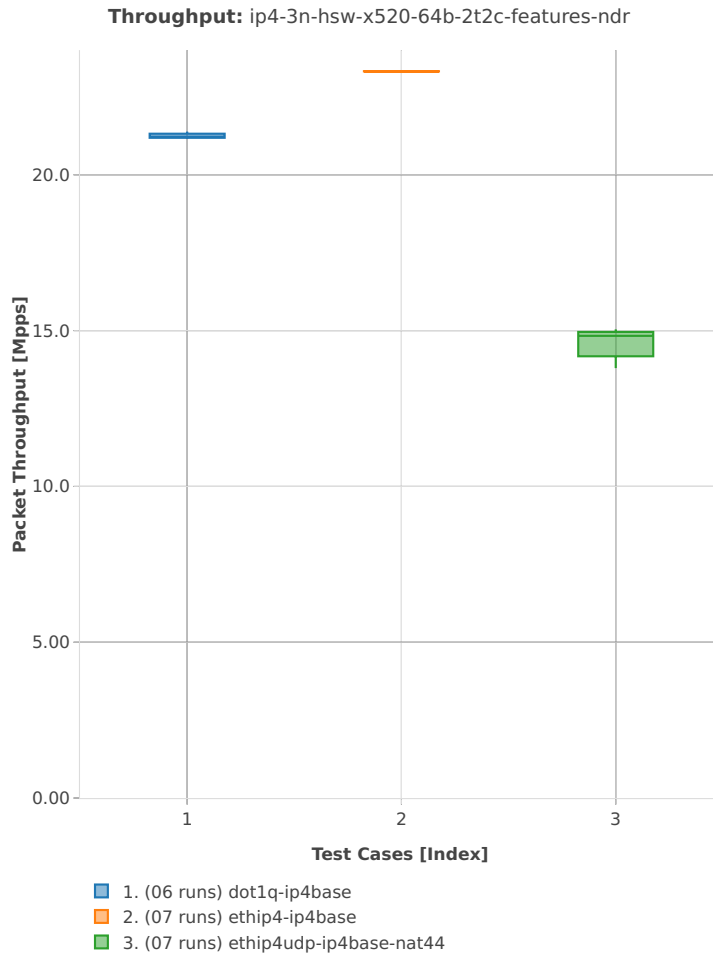

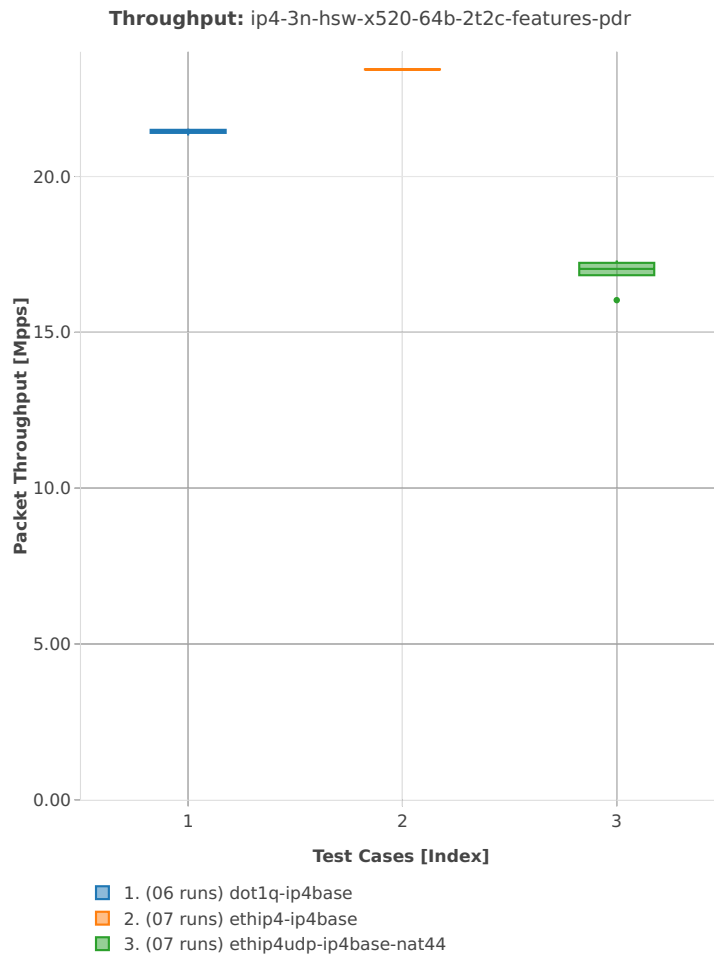

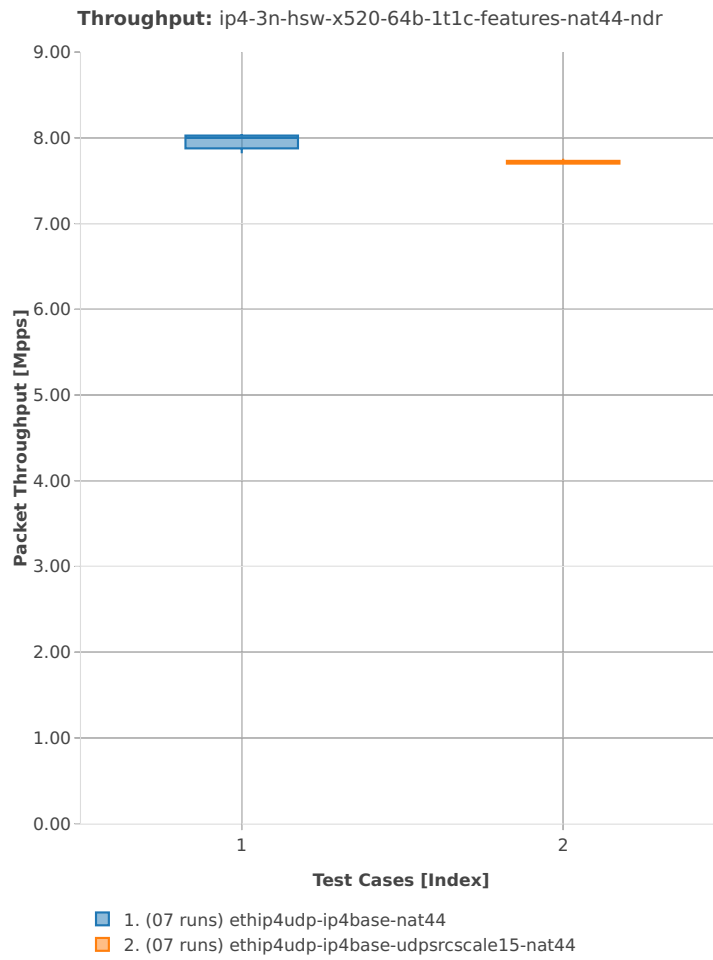
**64b-1t1c-features-nat44**

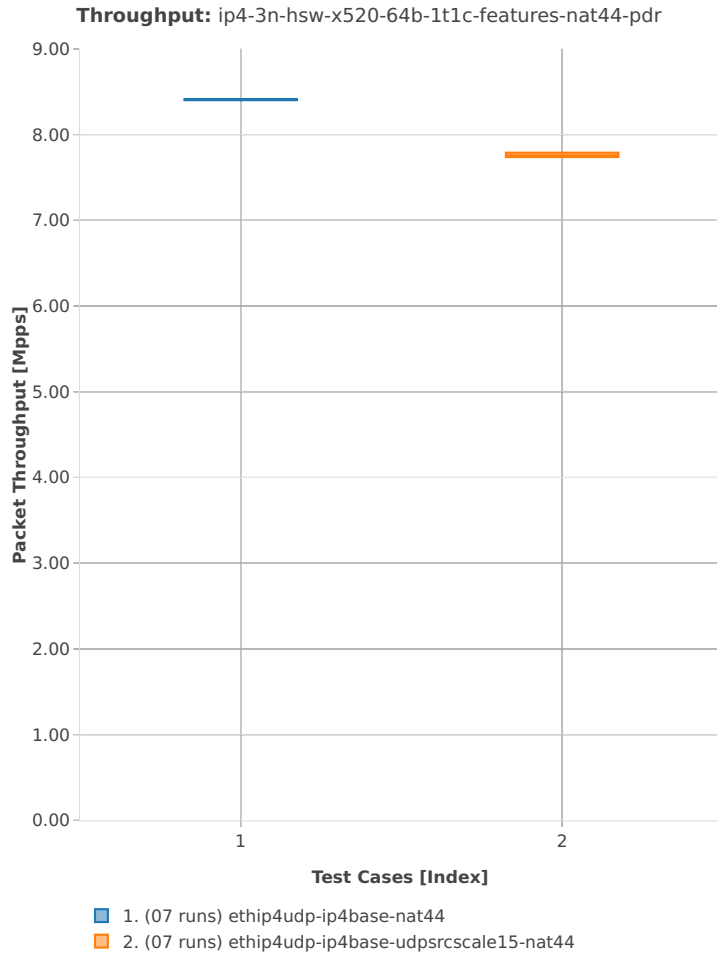

64b-2t2c-features-nat44

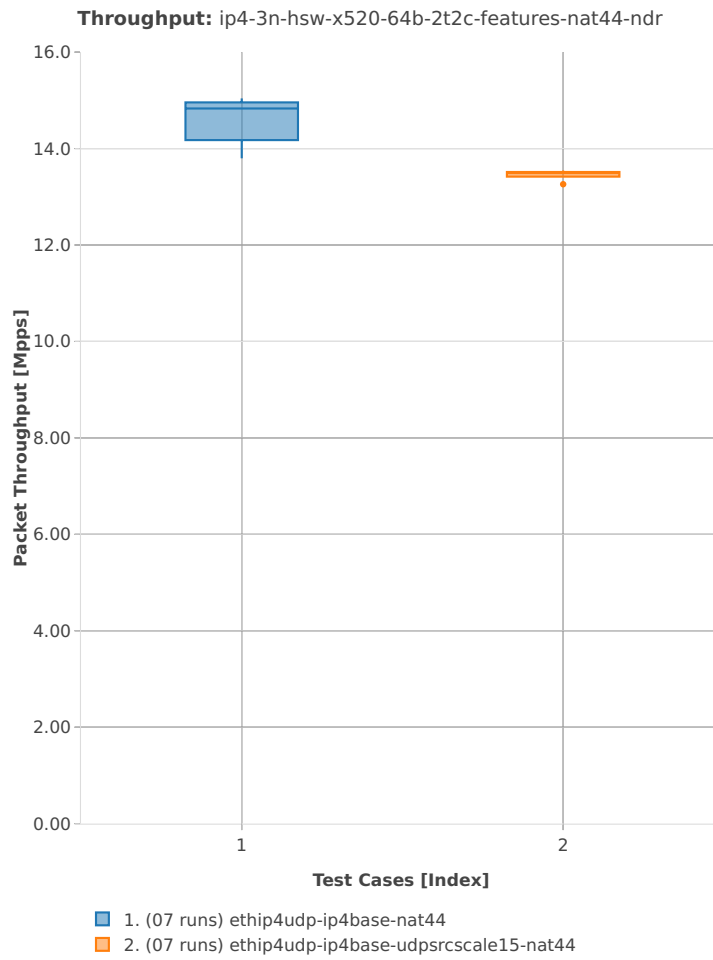



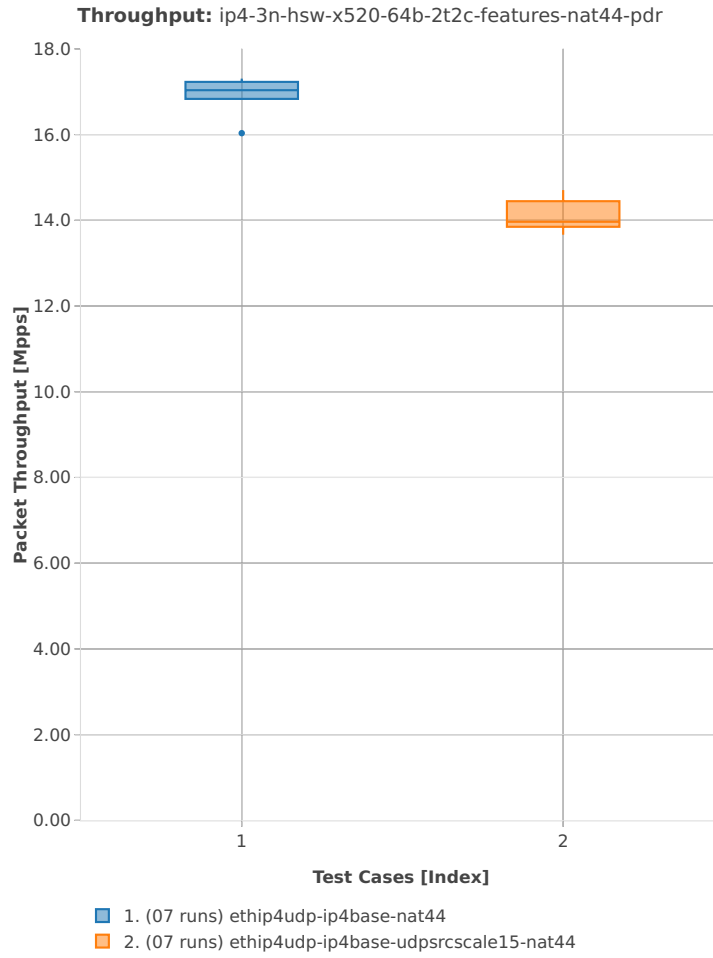

## 64b-1t1c-features-iacl

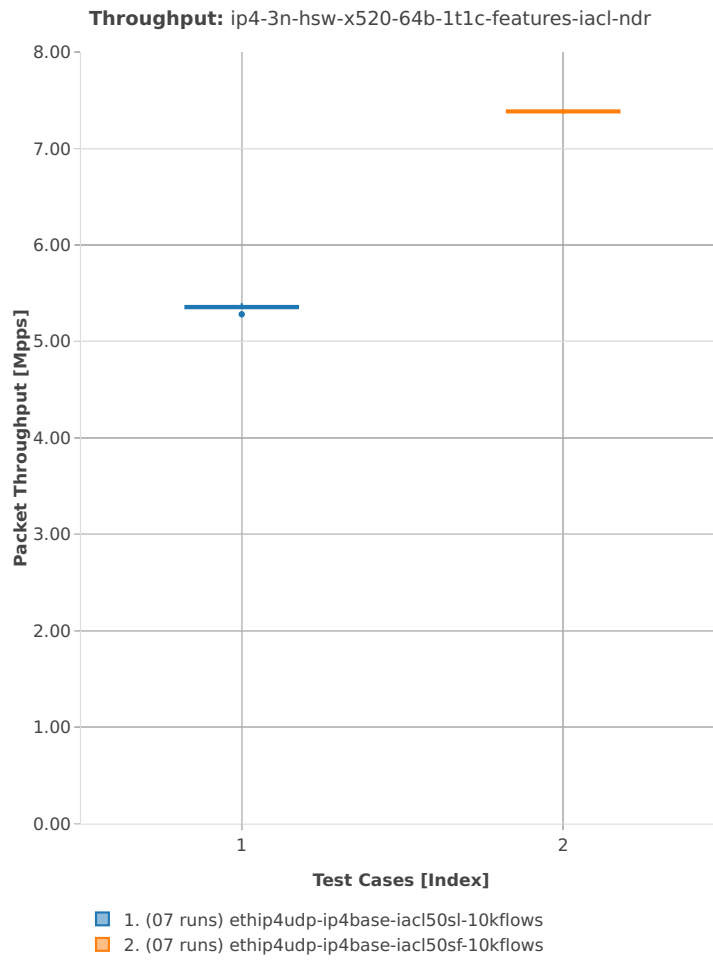

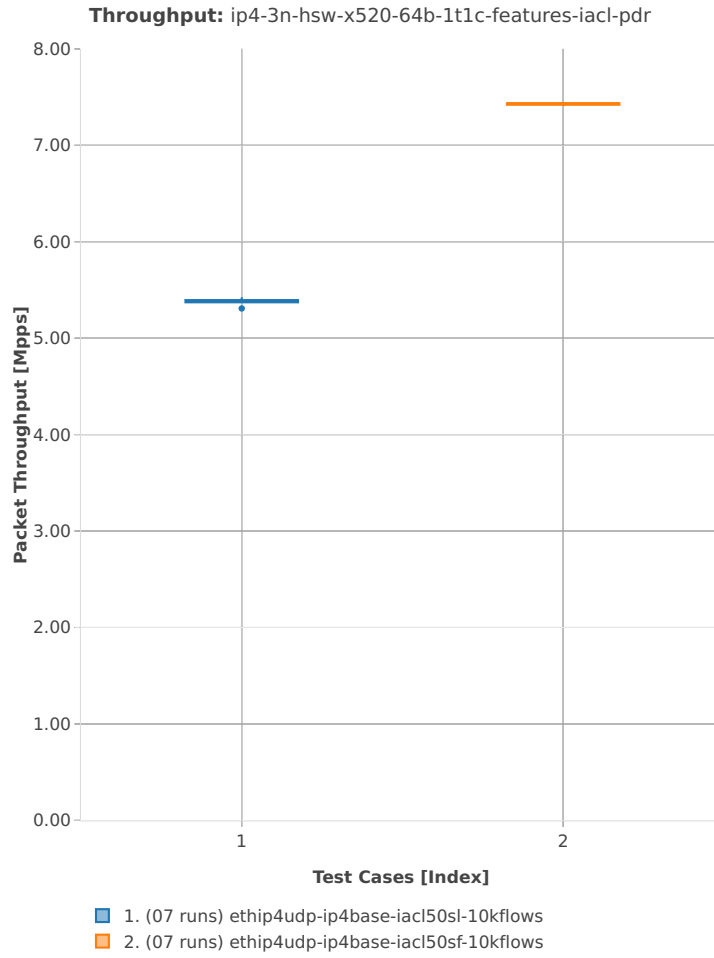

64b-2t2c-features-iacl

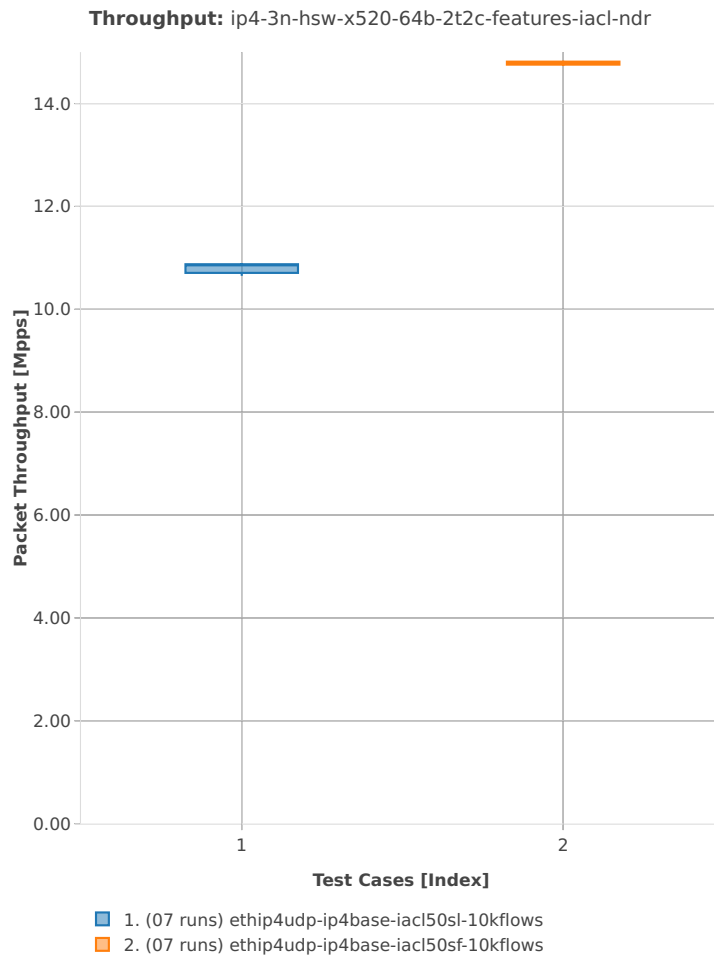

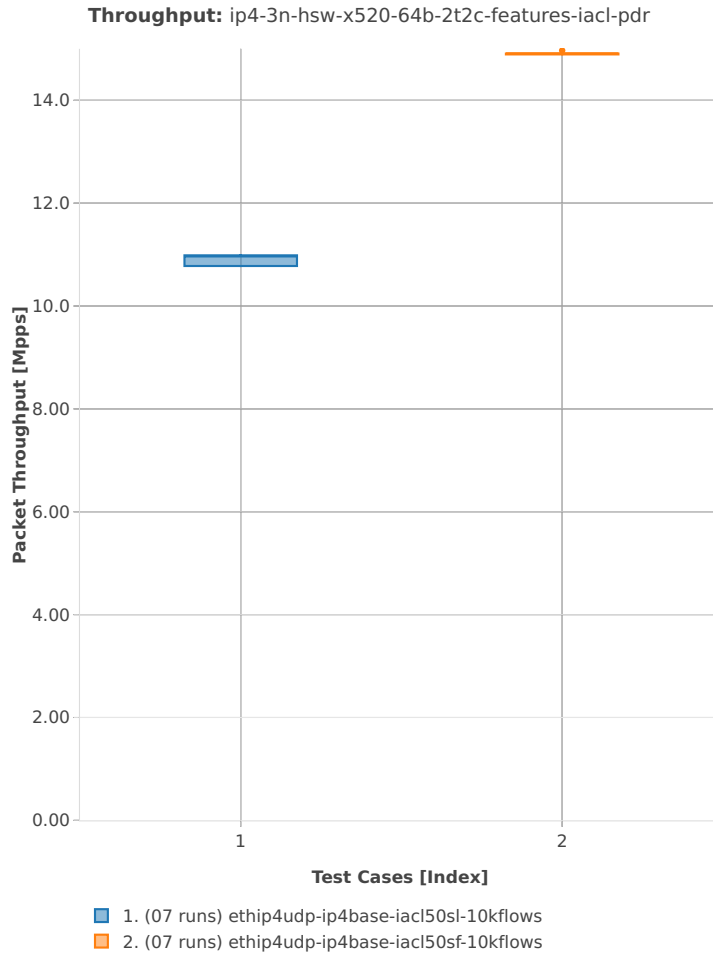

## 64b-1t1c-features-oacl

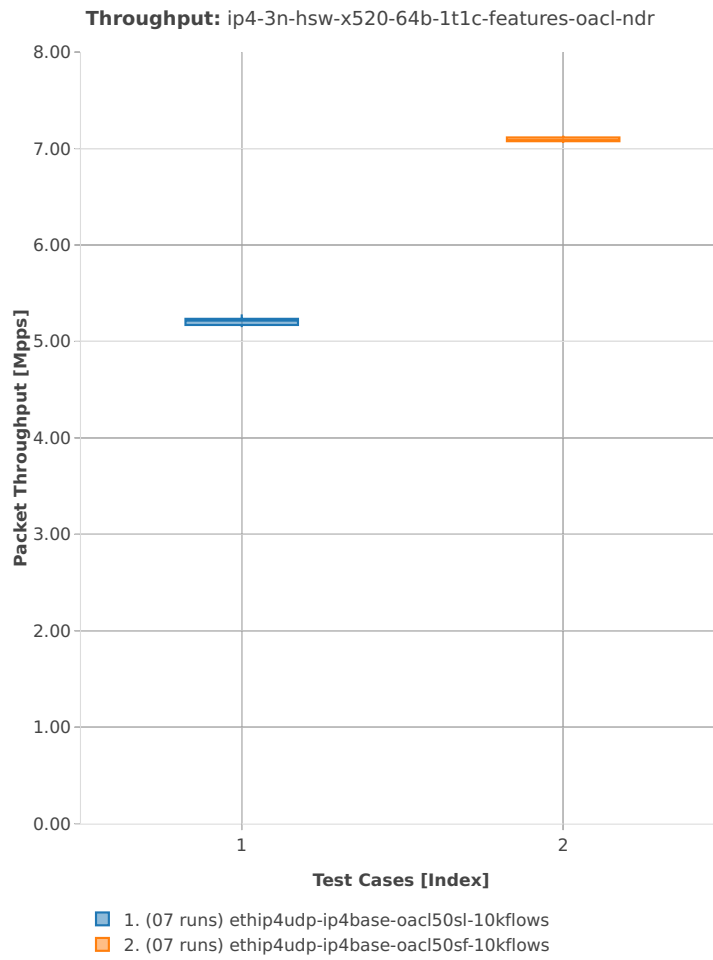

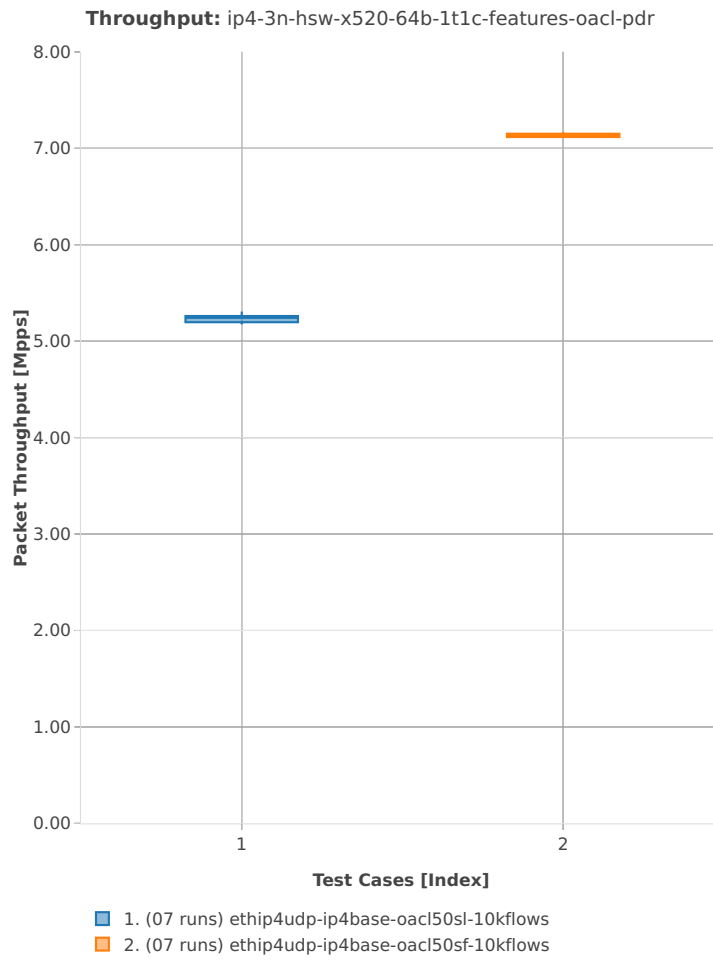

## 64b-2t2c-features-oacl

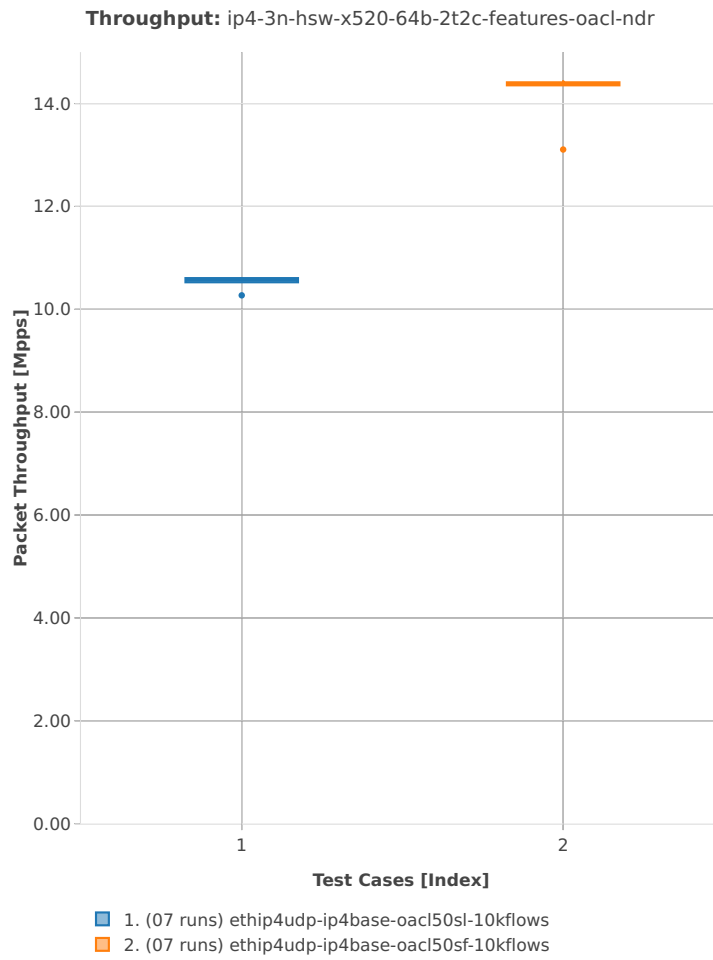



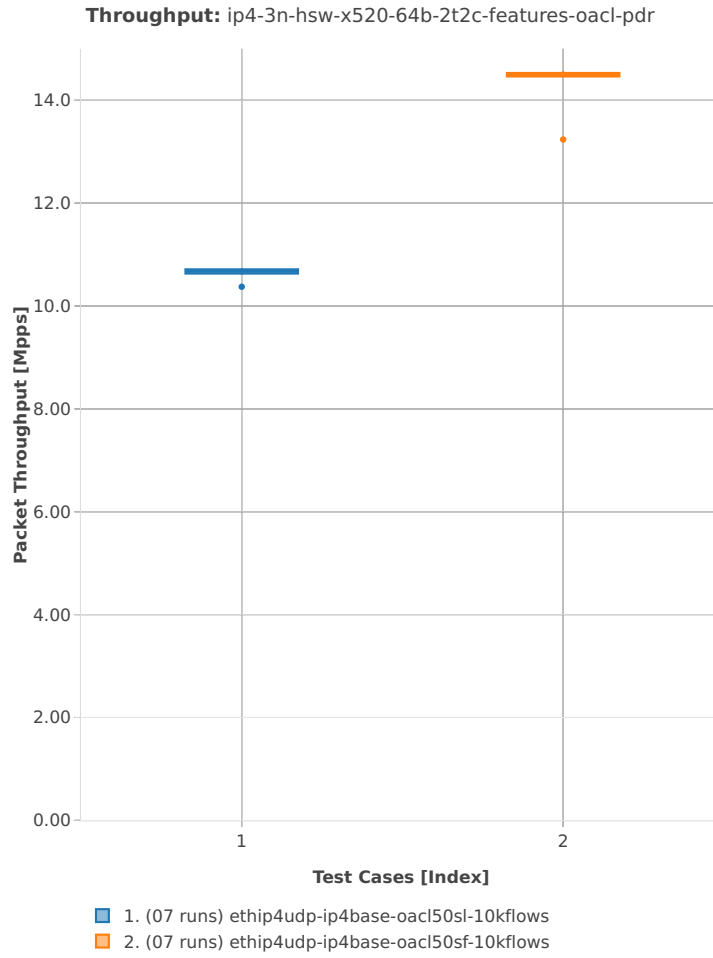

3n-hsw-x710

64b-1t1c-base\_and\_scale

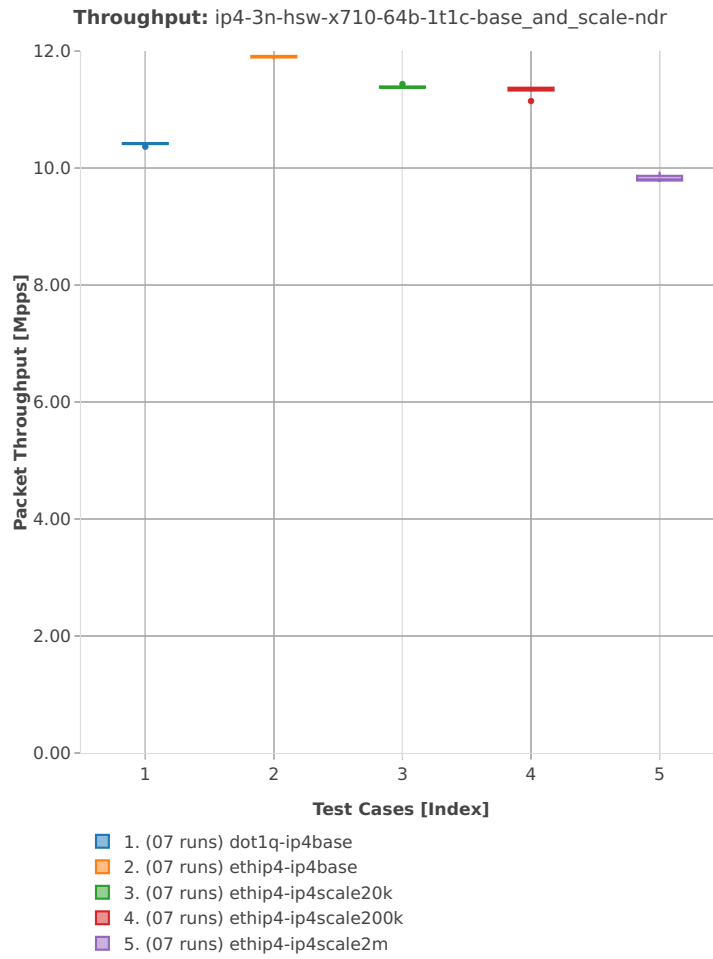

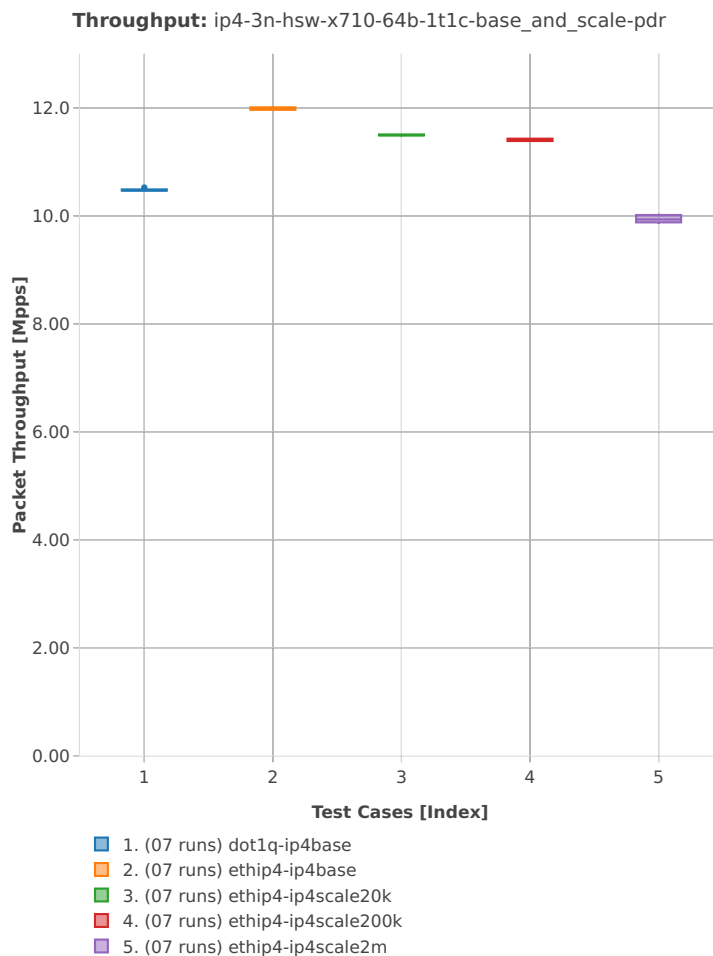

## 64b-2t2c-base\_and\_scale

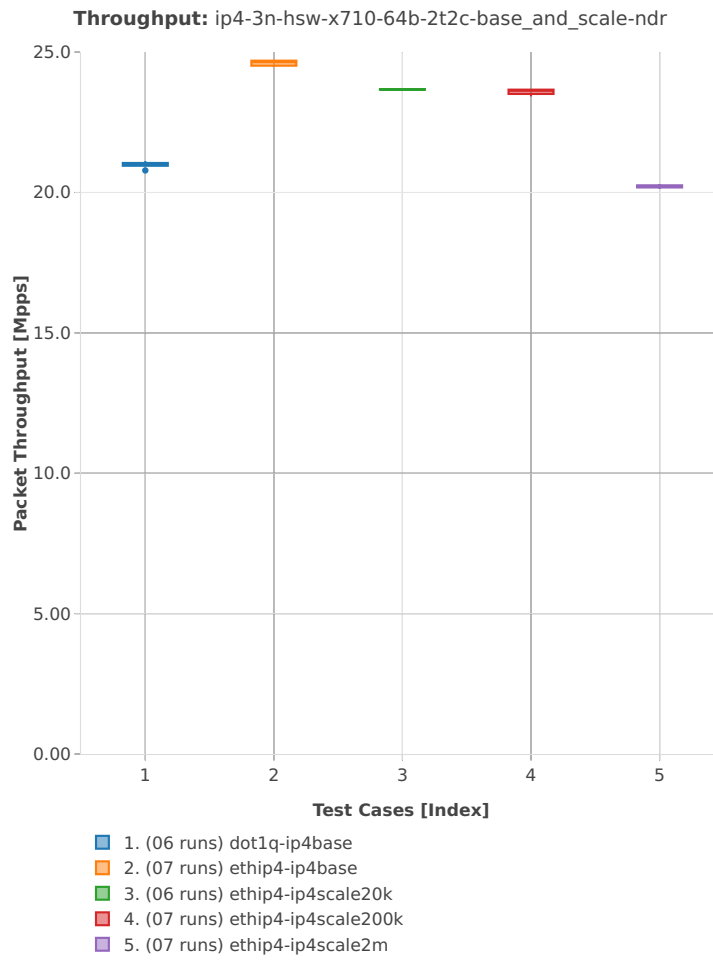

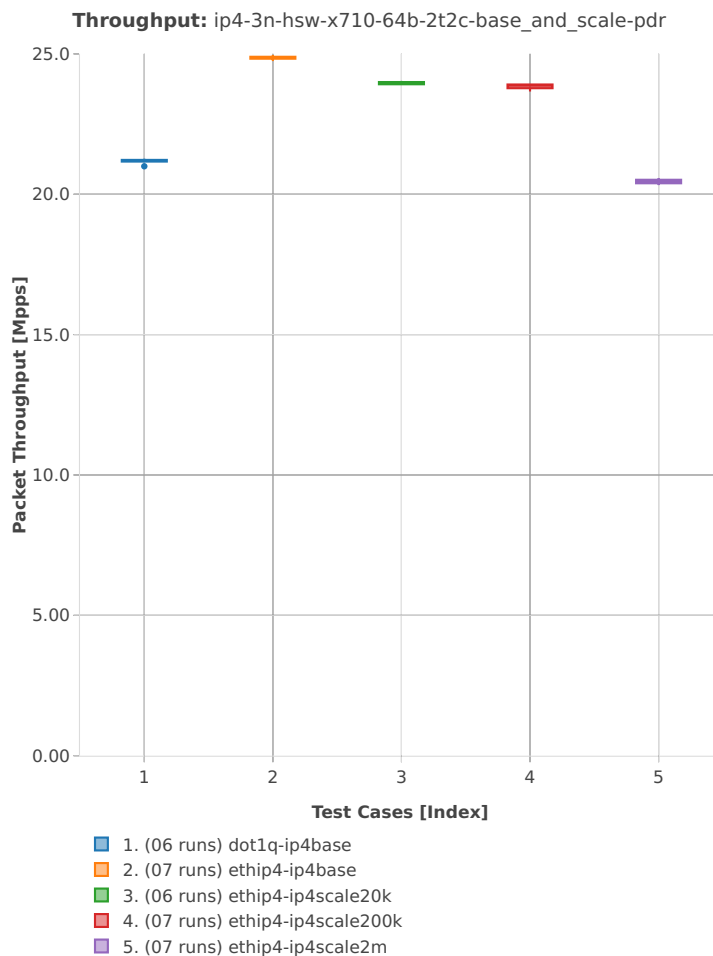

64b-1t1c-features

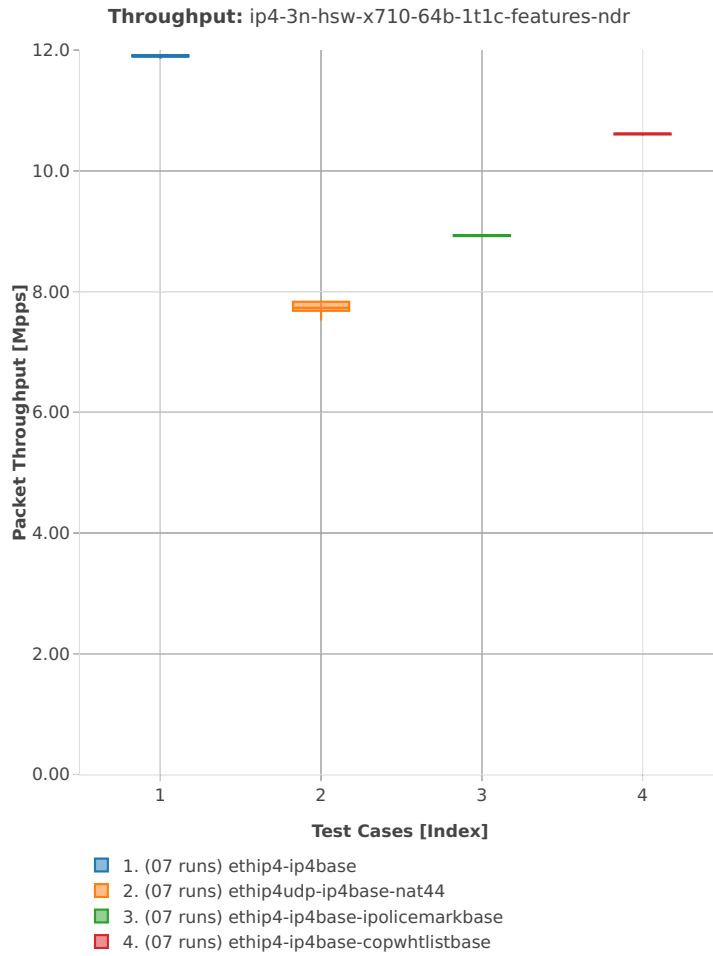

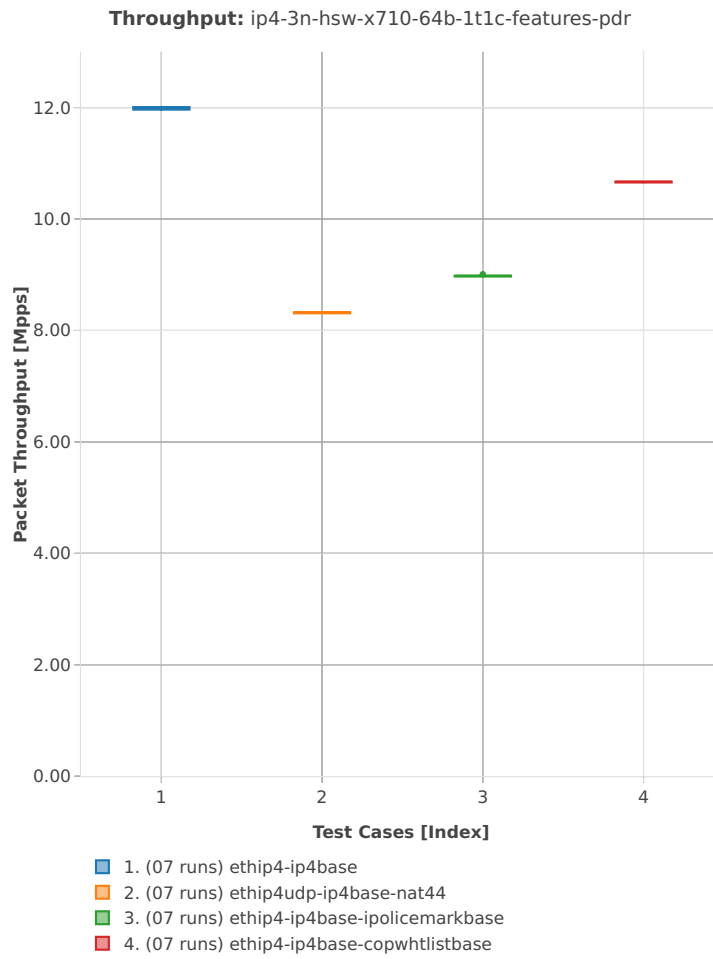

## 64b-2t2c-features

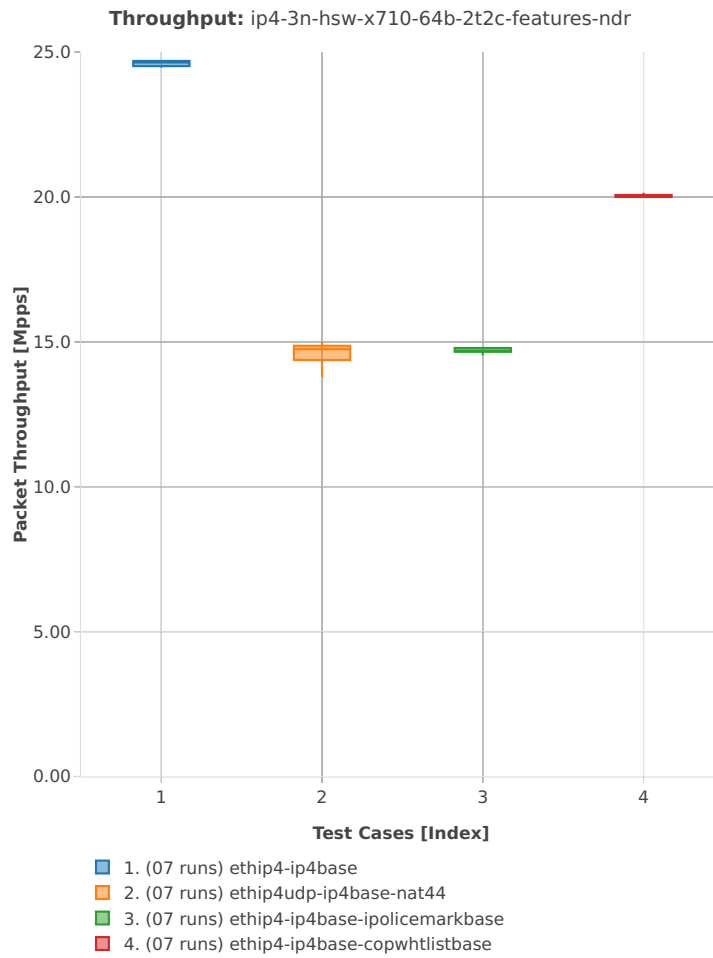



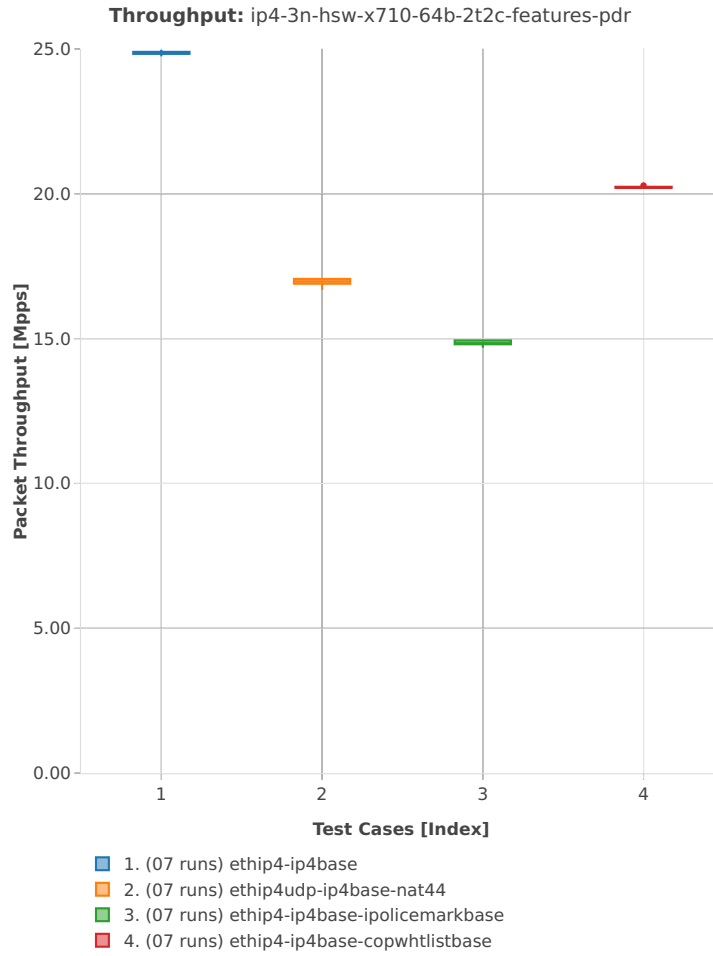

## 64b-1t1c-features-nat44

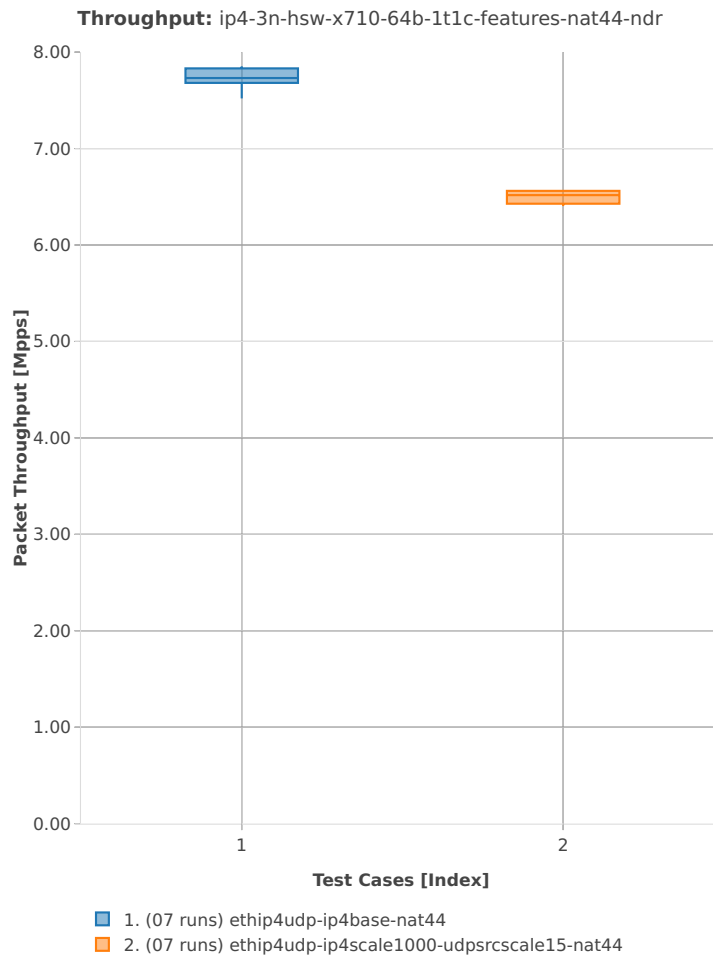

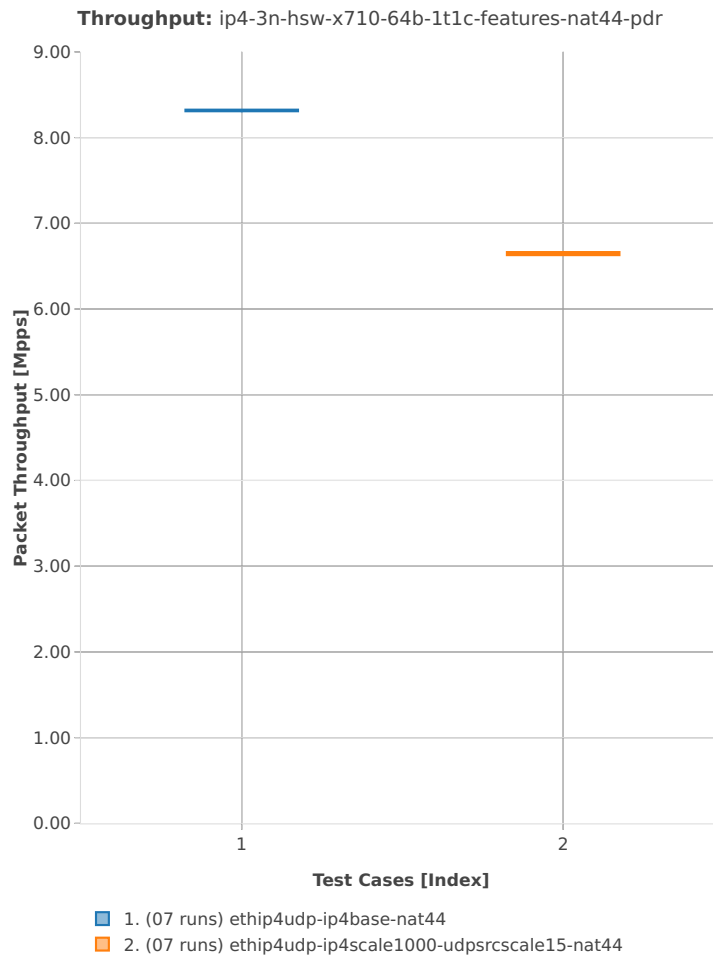

## 64b-2t2c-features-nat44

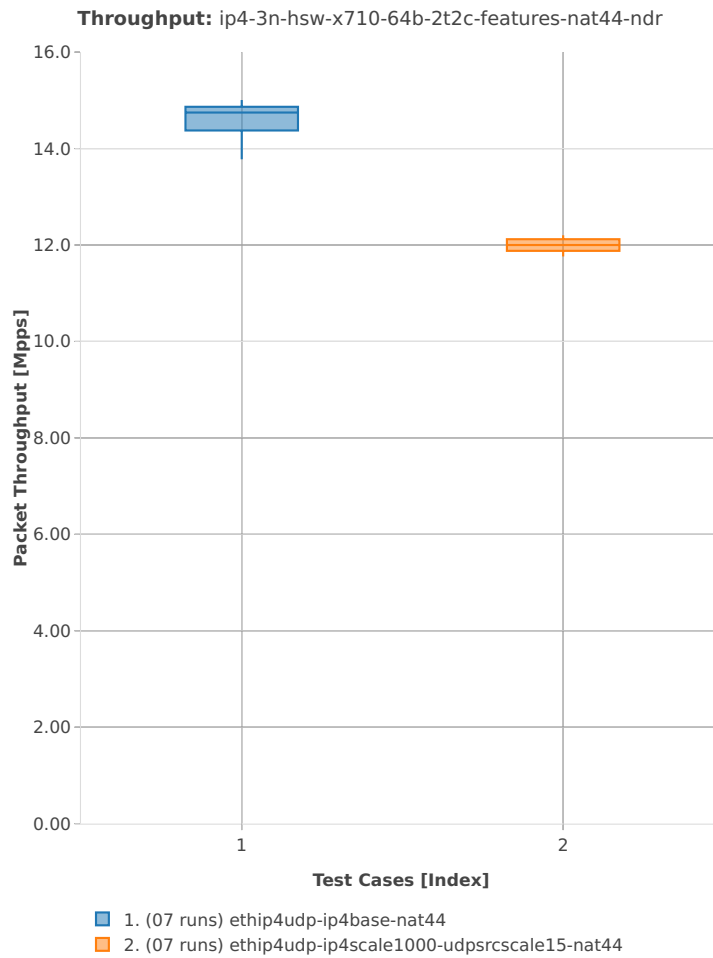

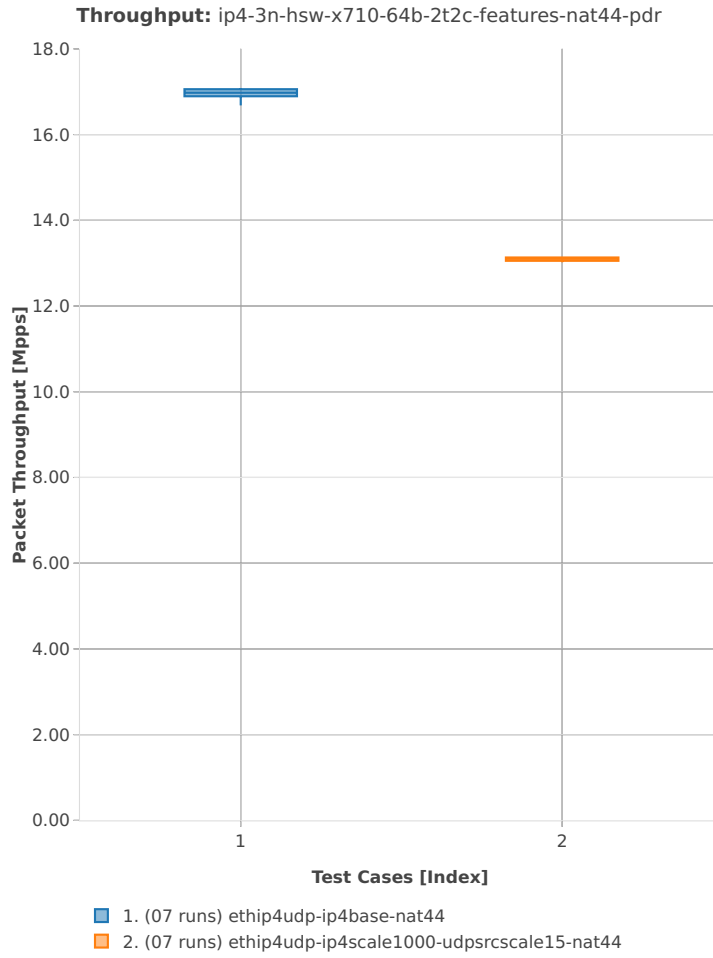

## 64b-1t1c-features-iacl

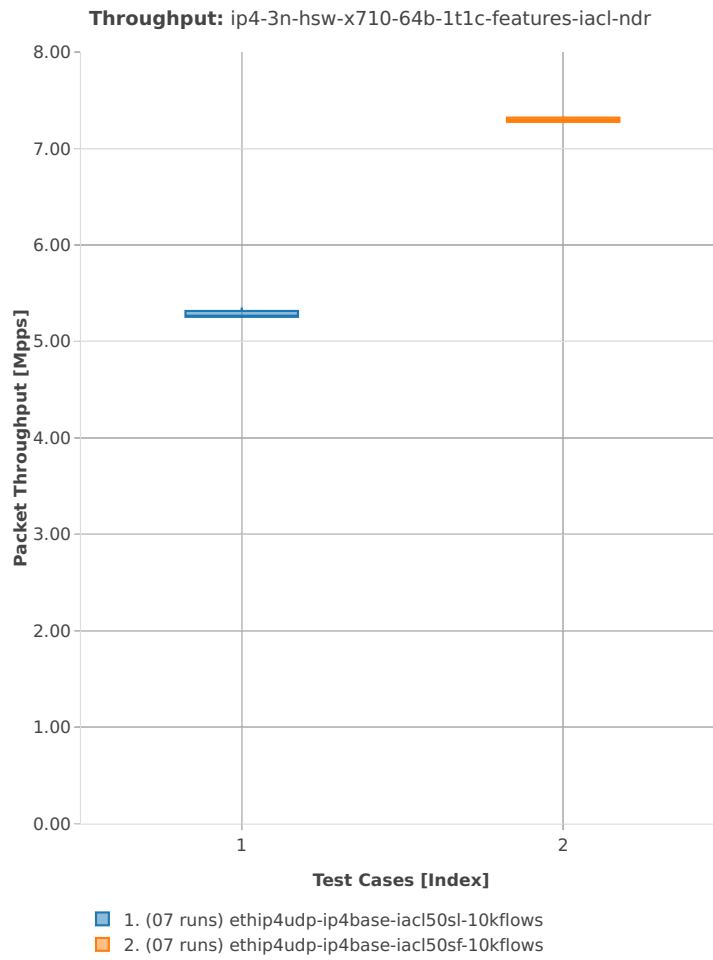

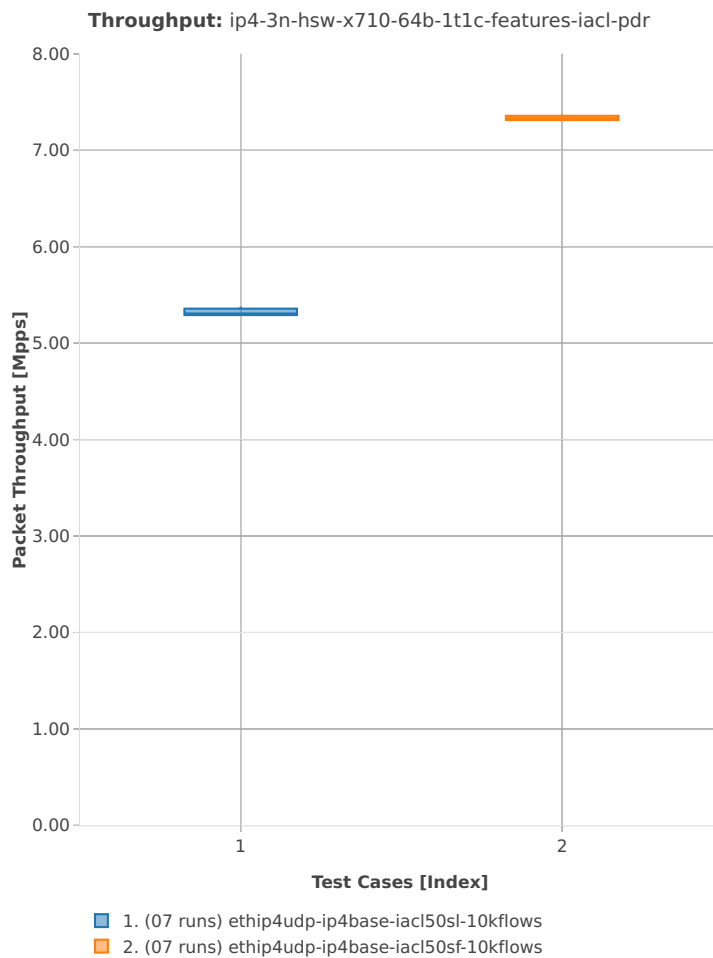

## 64b-2t2c-features-iacl

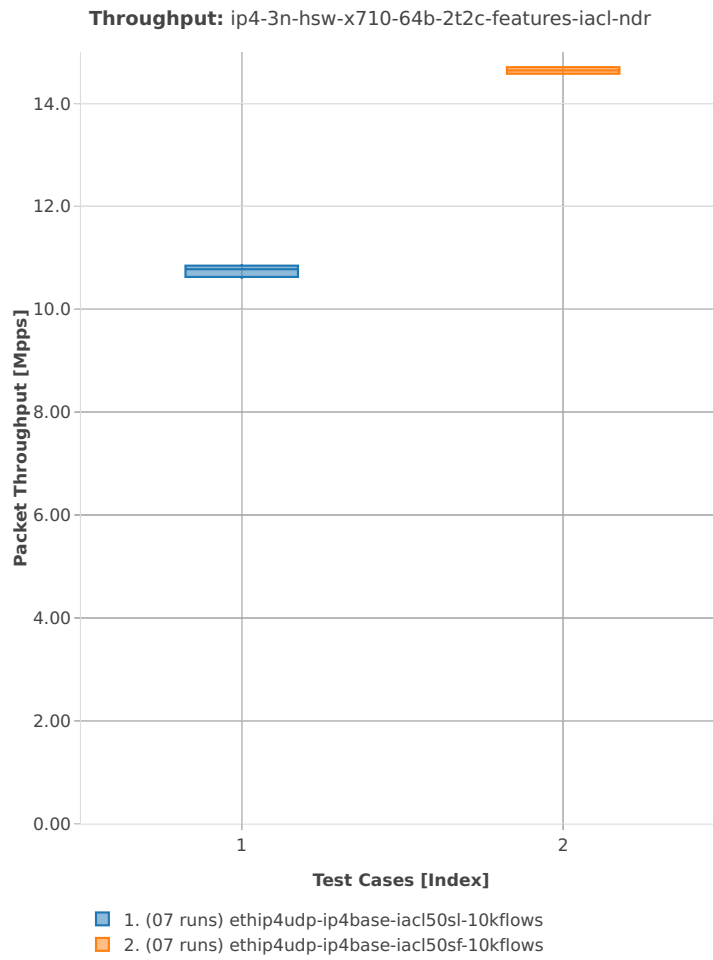



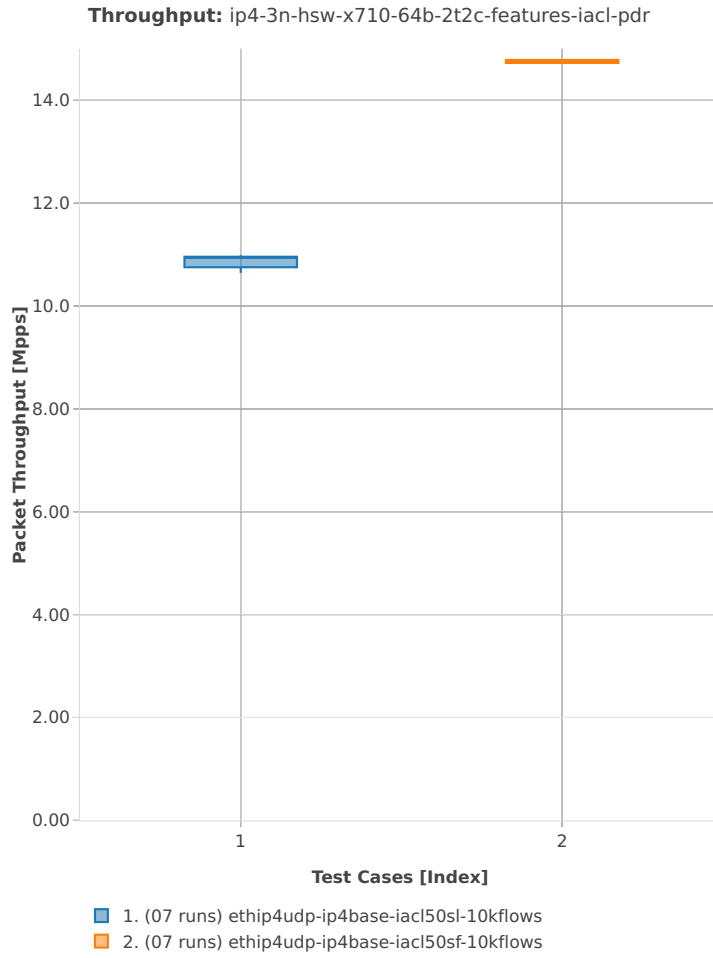

3n-hsw-xl710

64b-1t1c-base\_and\_scale

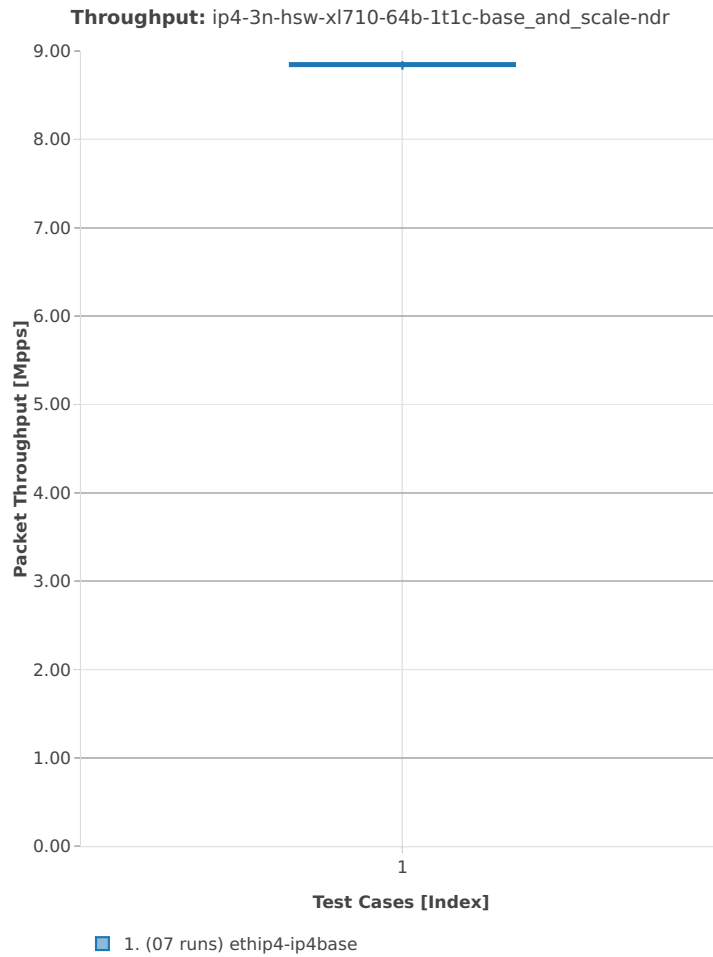

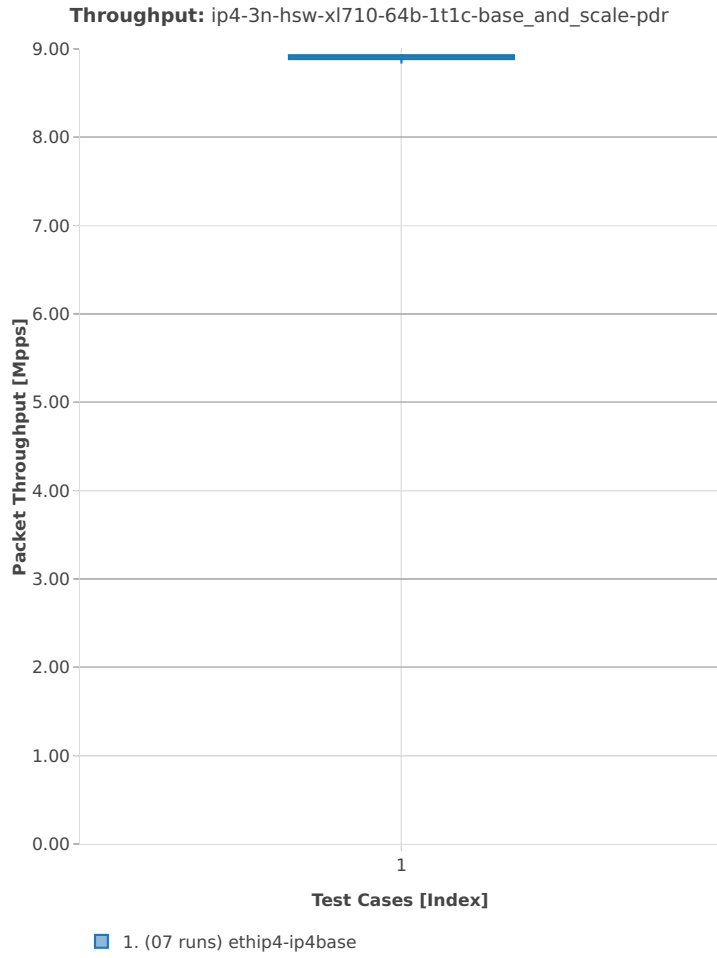

## 64b-2t2c-base\_and\_scale

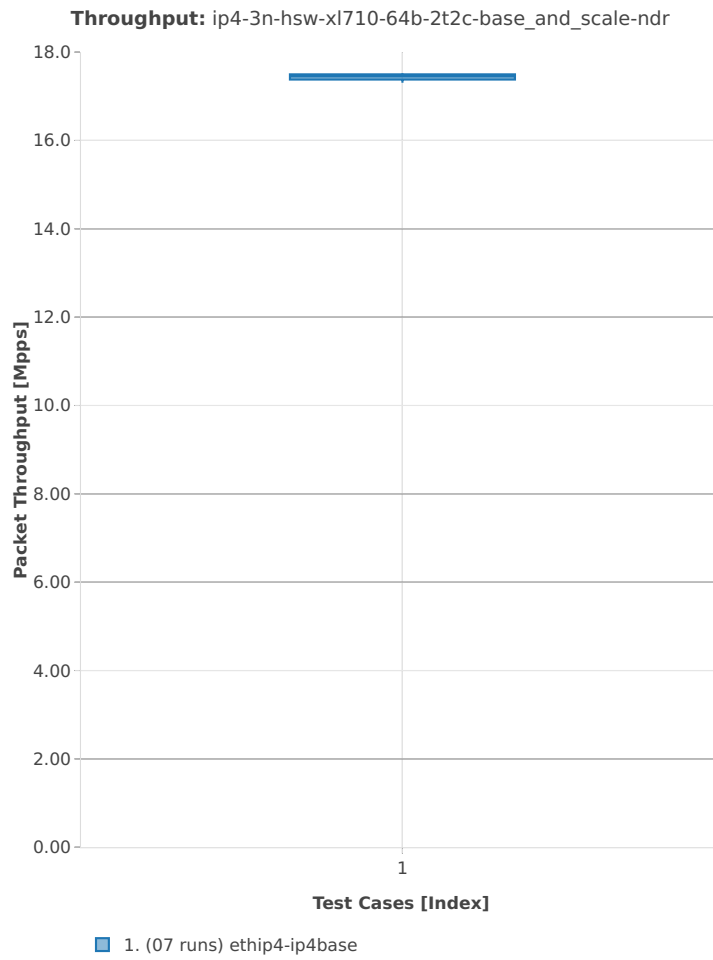

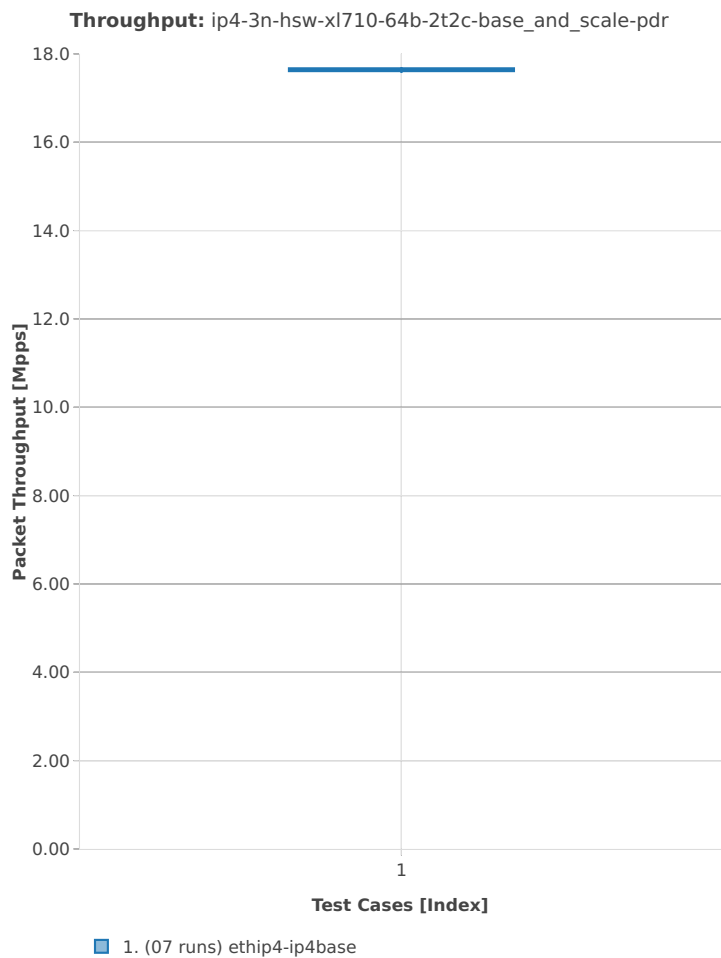

3n-skx-x710

64b-2t1c-base\_and\_scale

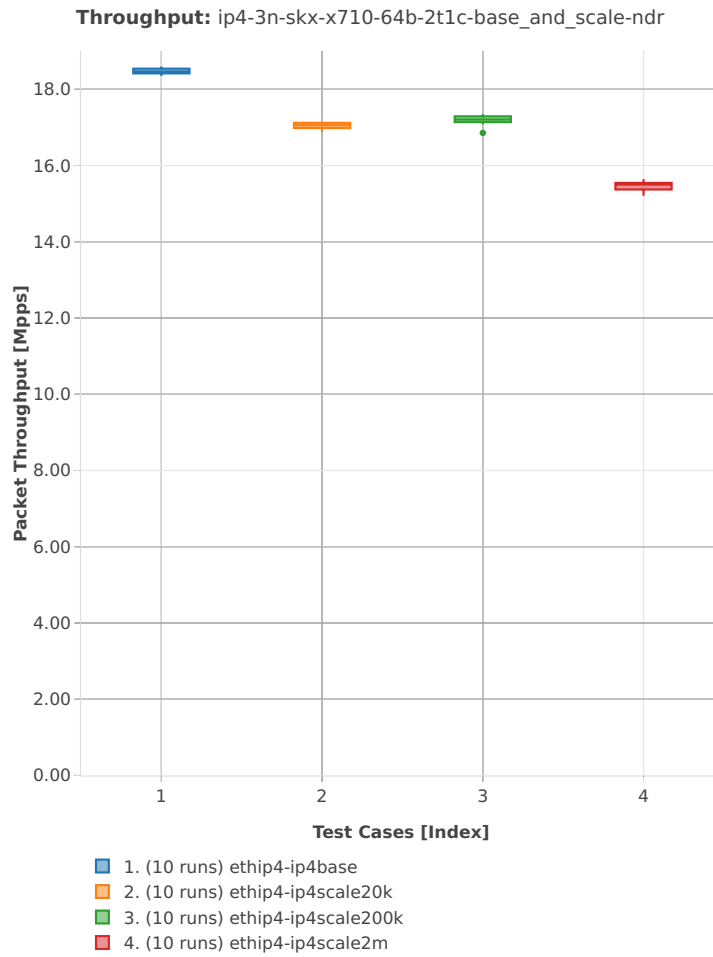

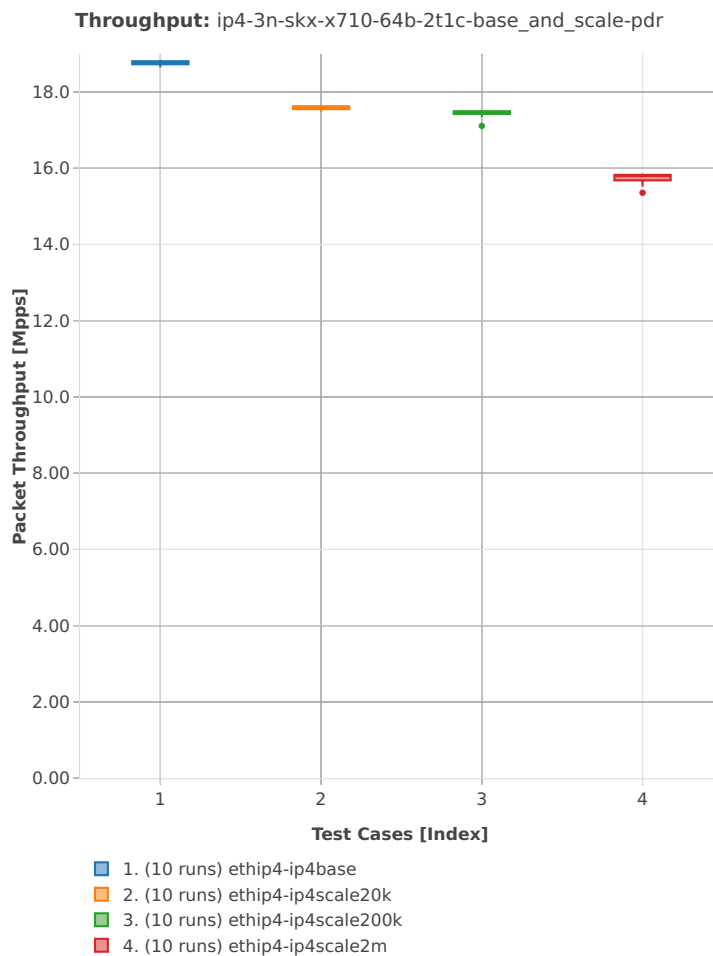

## 64b-4t2c-base\_and\_scale

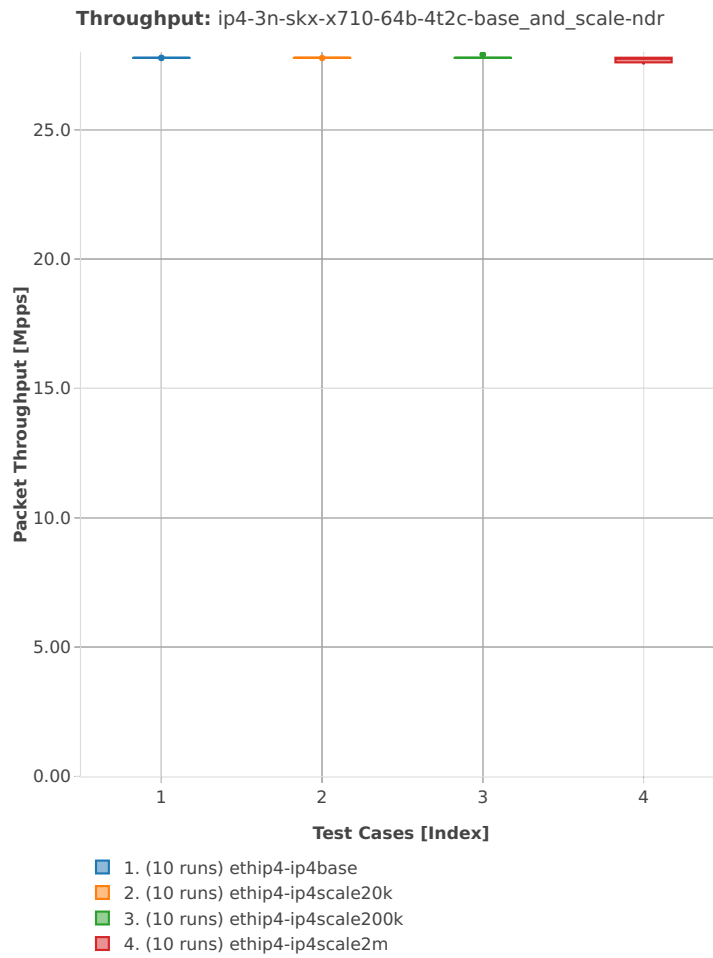



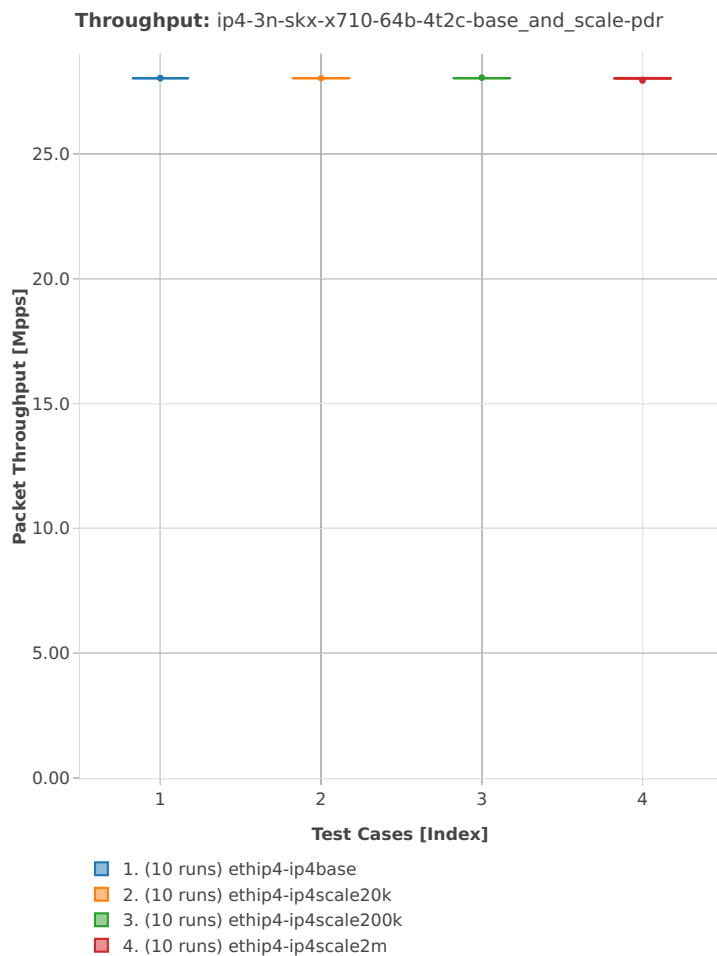

64b-2t1c-features

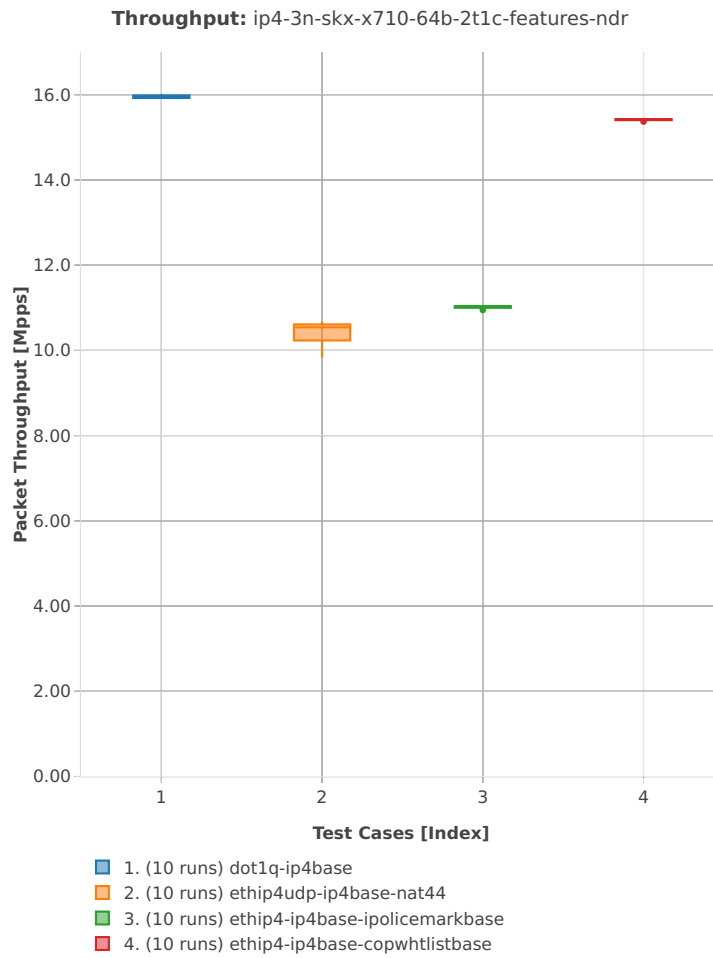

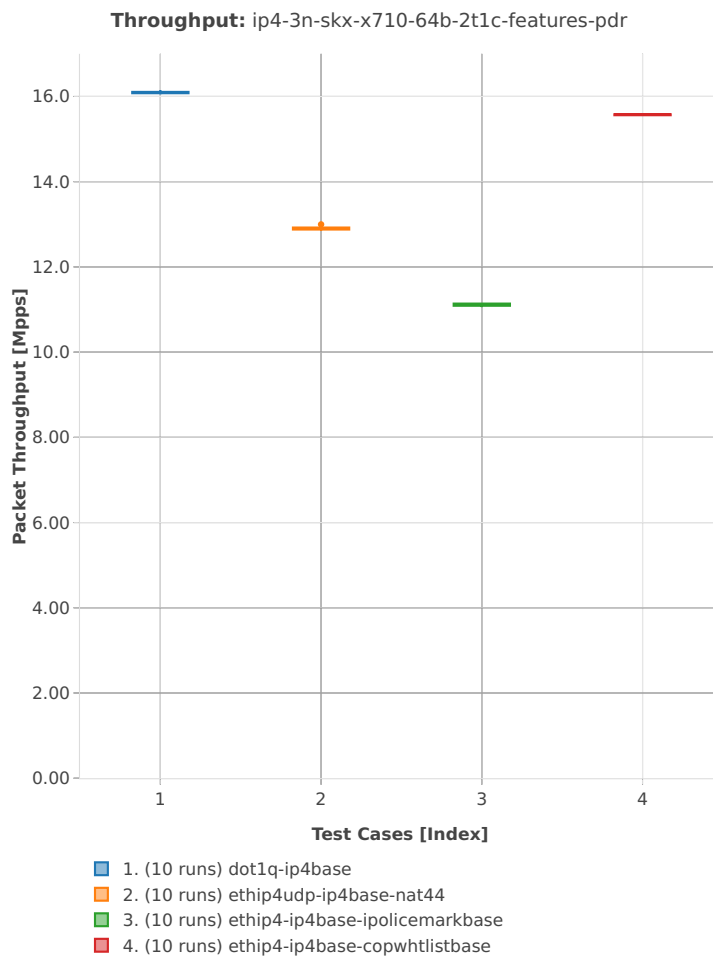

64b-4t2c-features

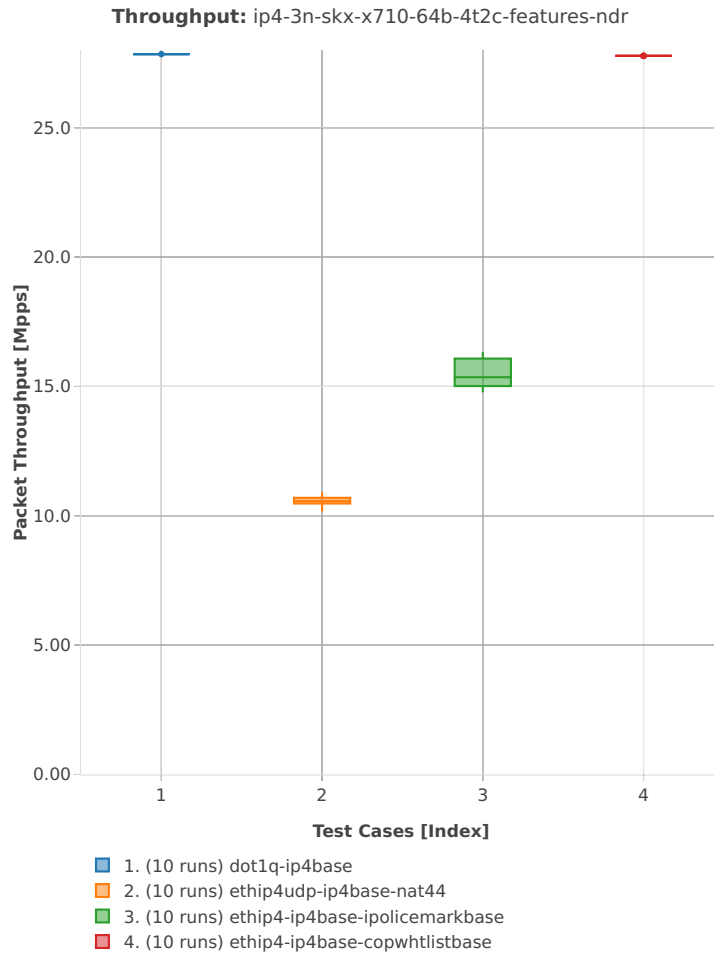

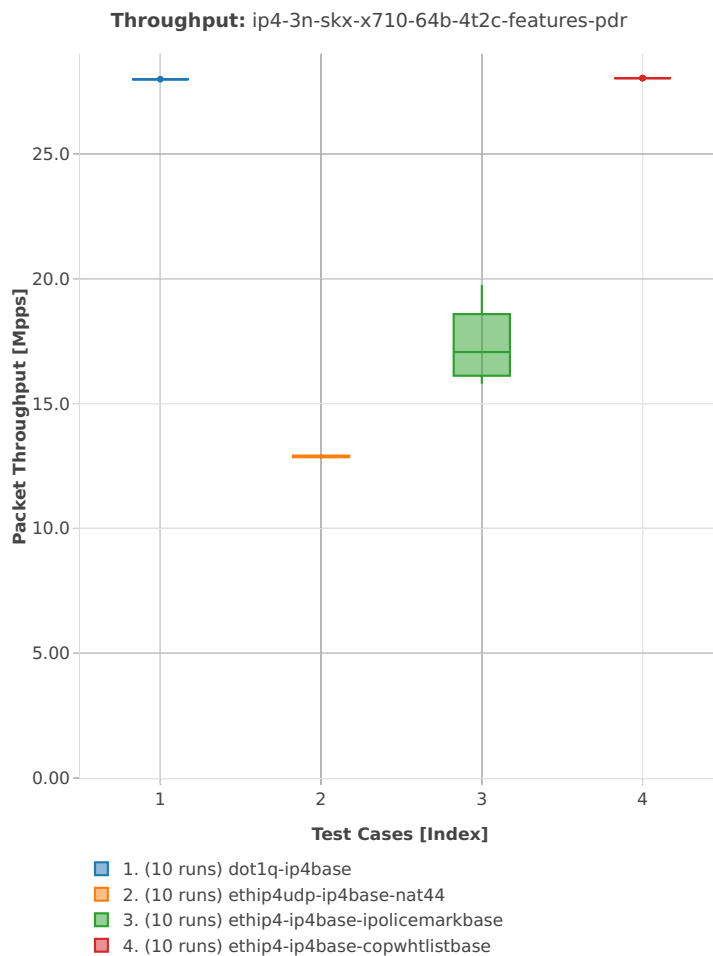

## 64b-2t1c-features-nat44

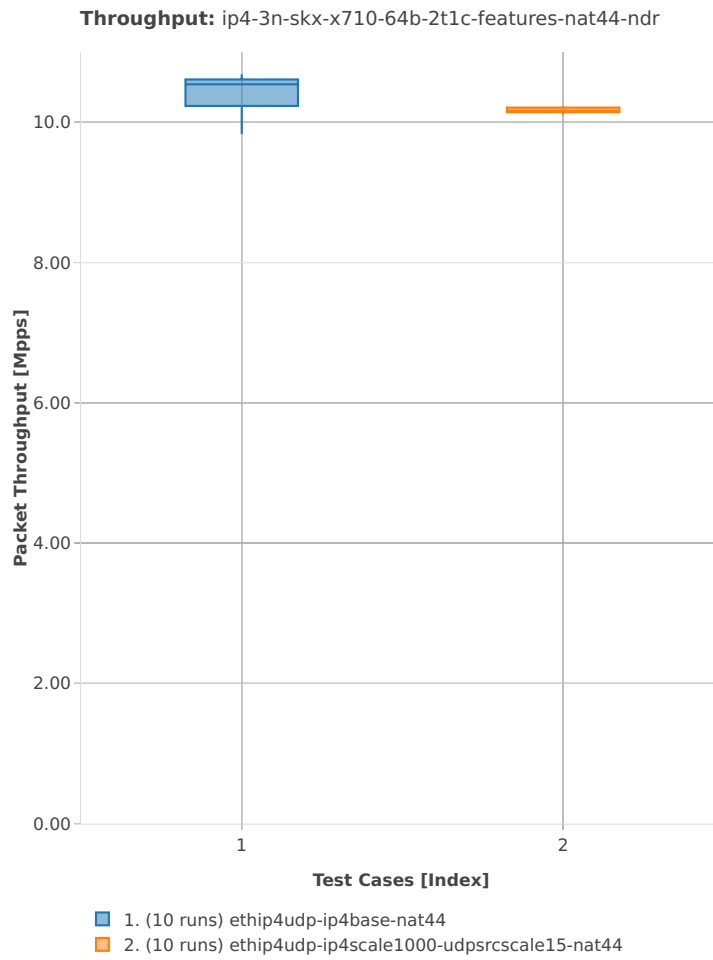

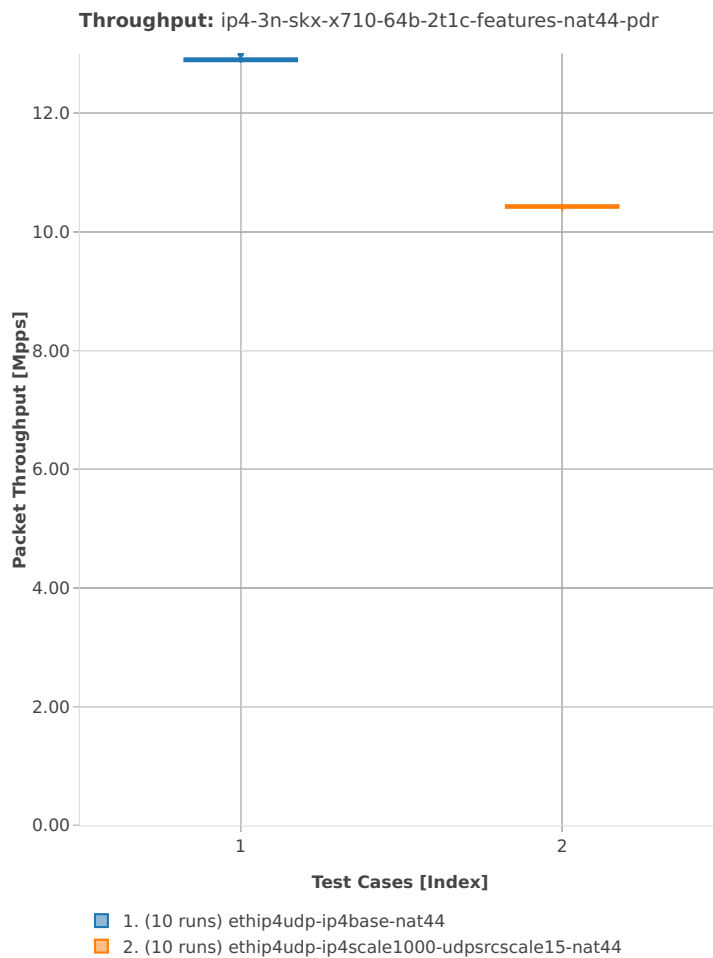

## 64b-4t2c-features-nat44

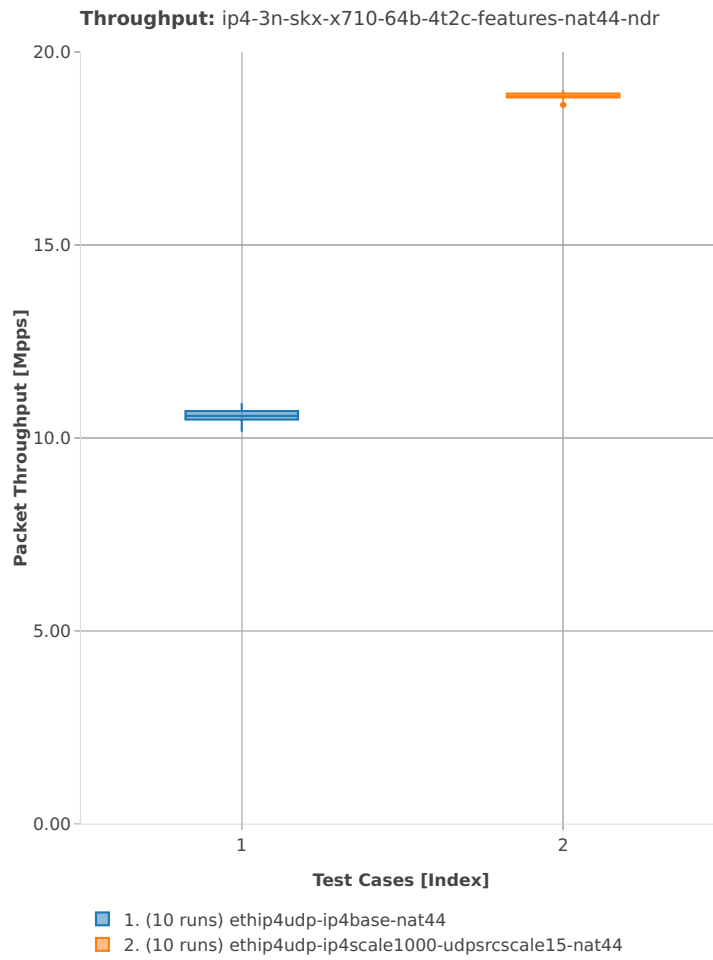



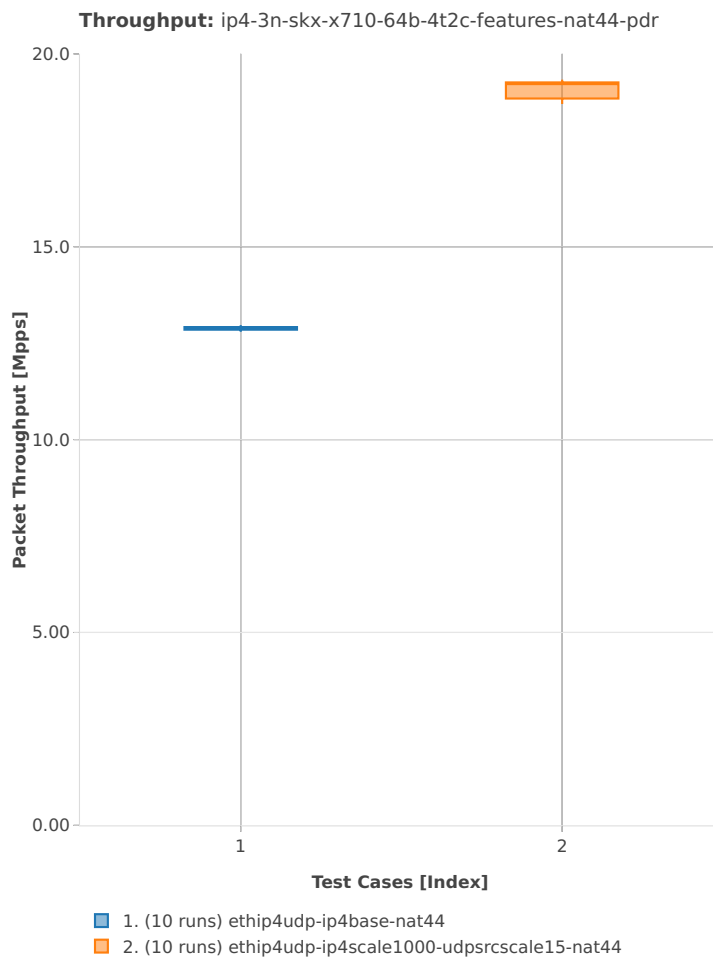

## 64b-2t1c-features-iacl

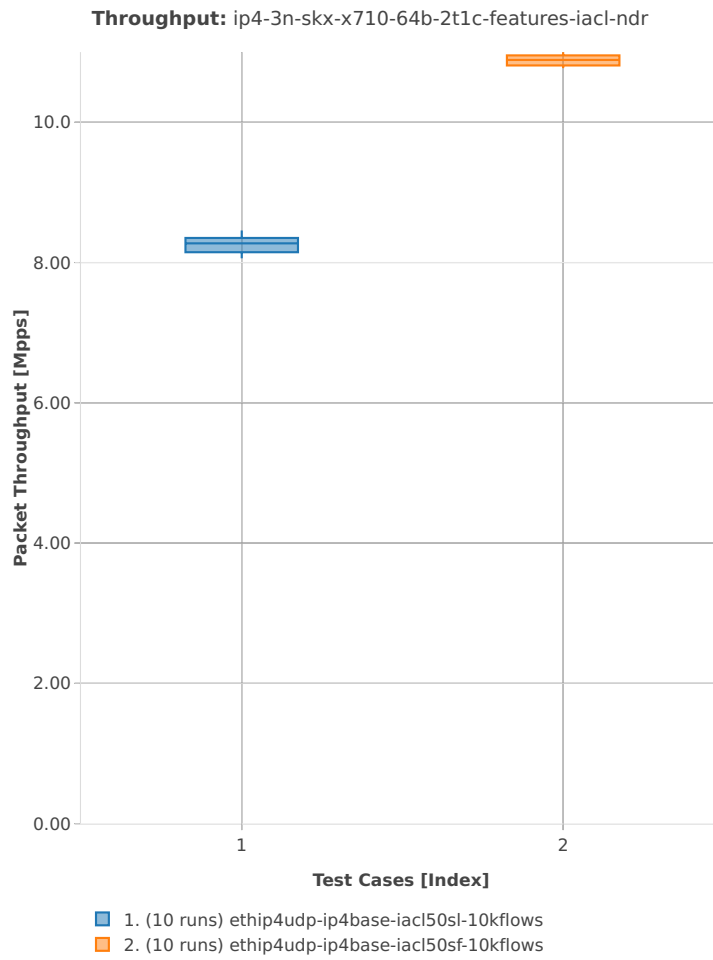

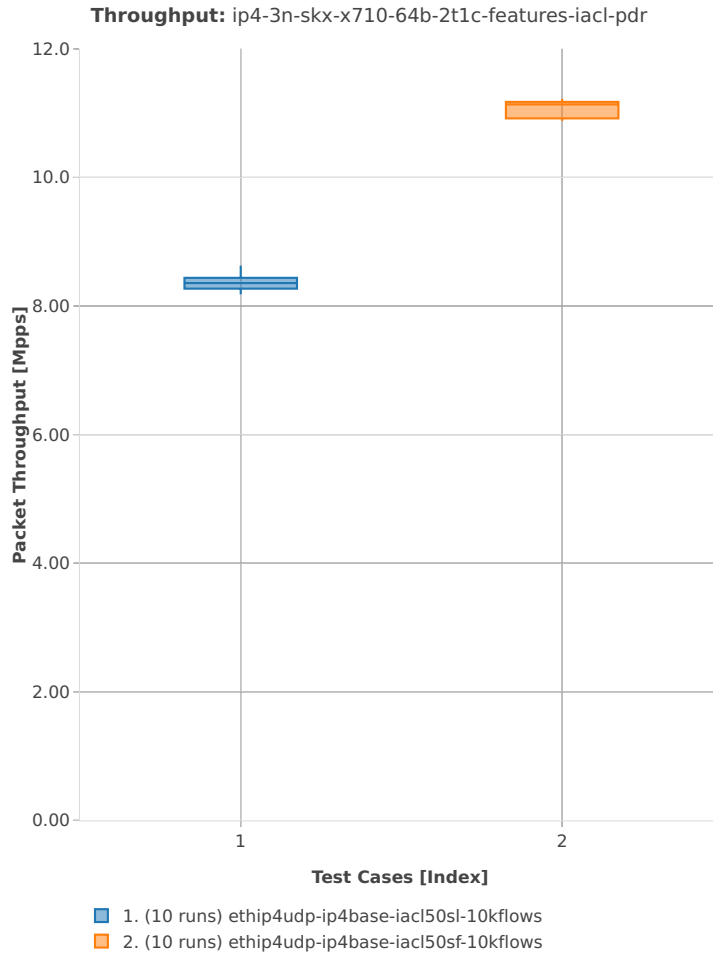

## 64b-4t2c-features-iacl

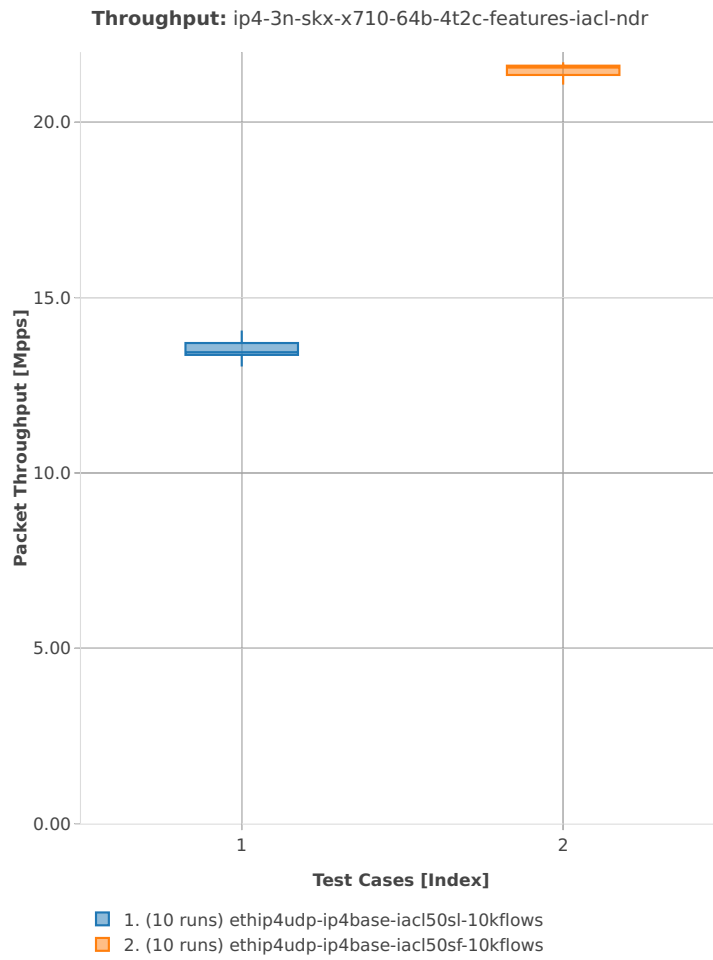

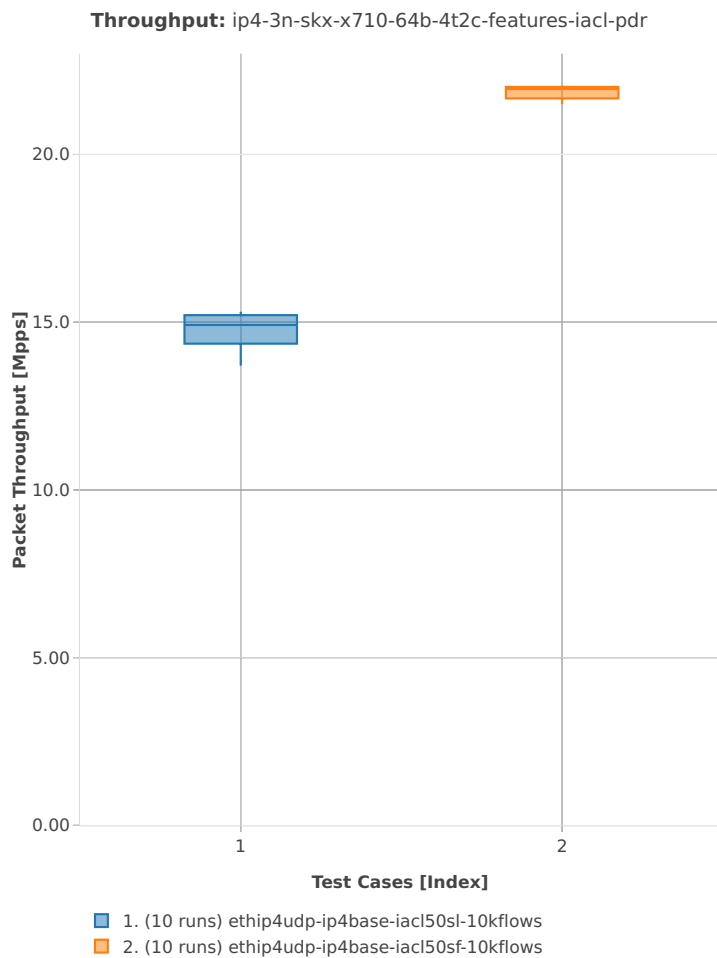

2n-skx-x710

64b-2t1c-base\_and\_scale

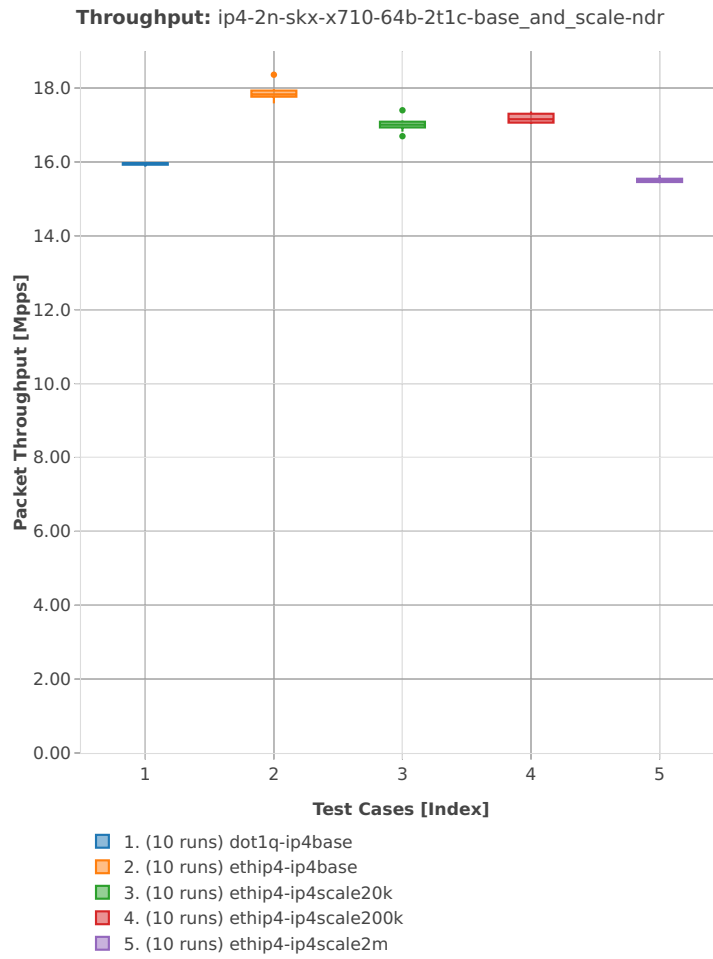

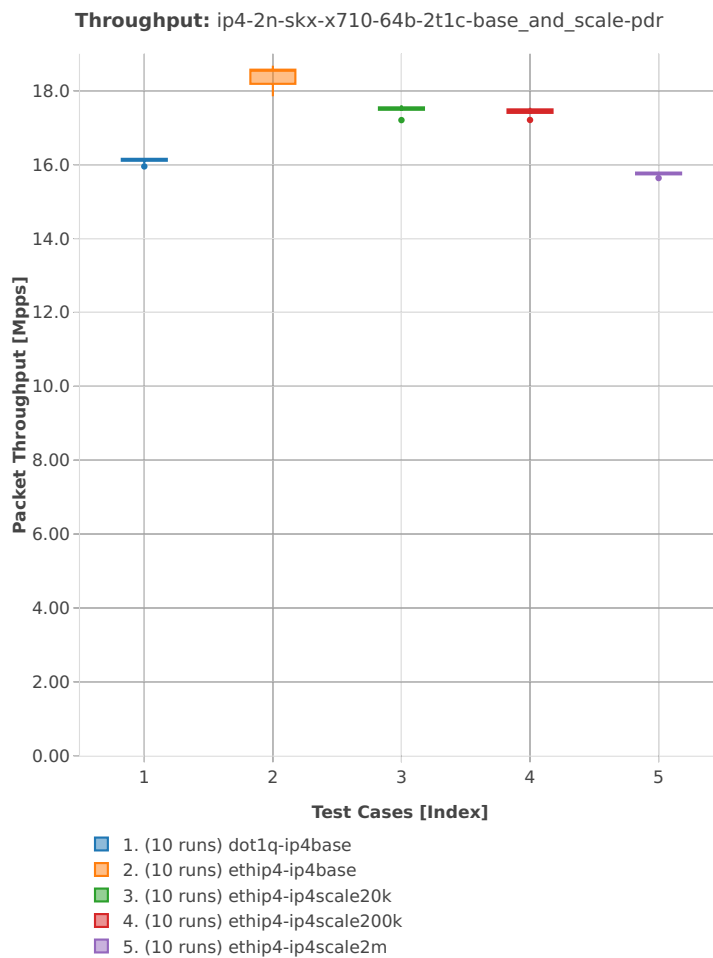

64b-4t2c-base\_and\_scale

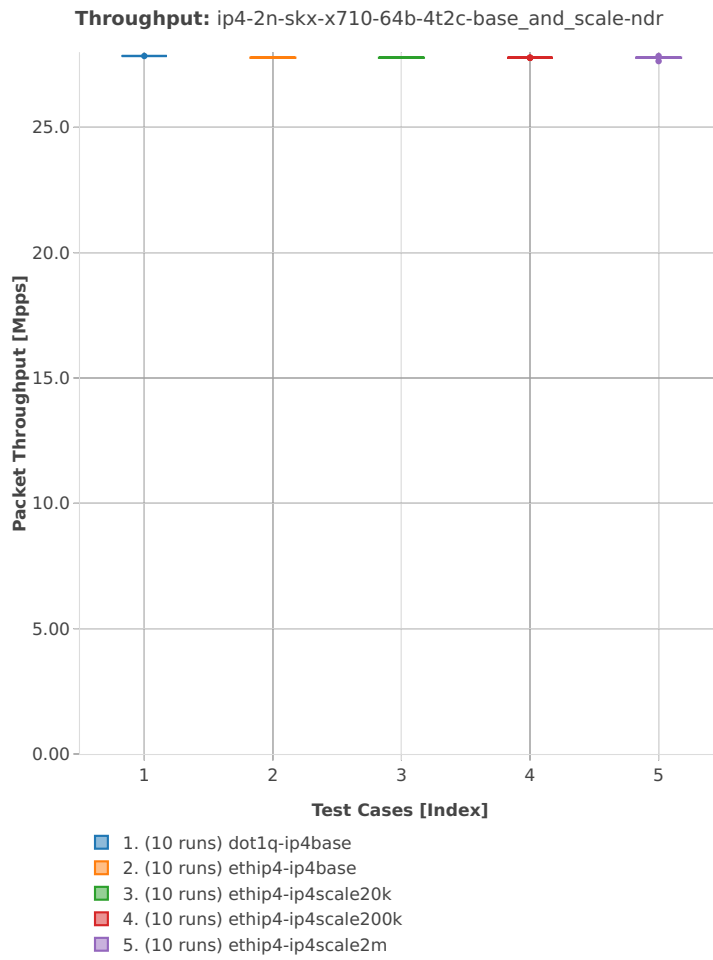



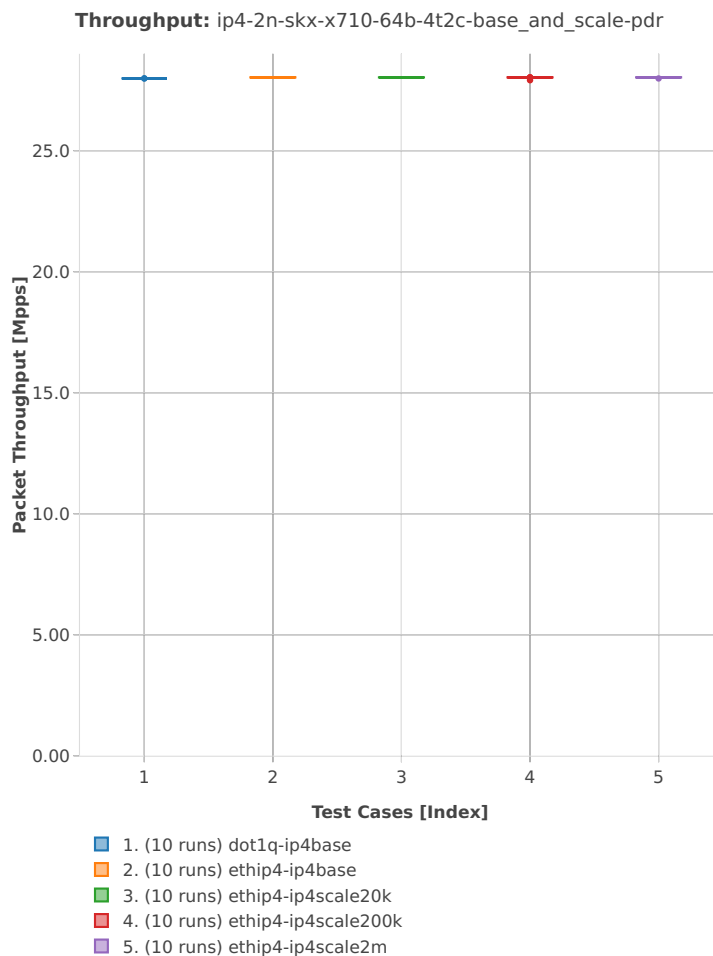

2n-skx-xxv710

64b-2t1c-base\_and\_scale

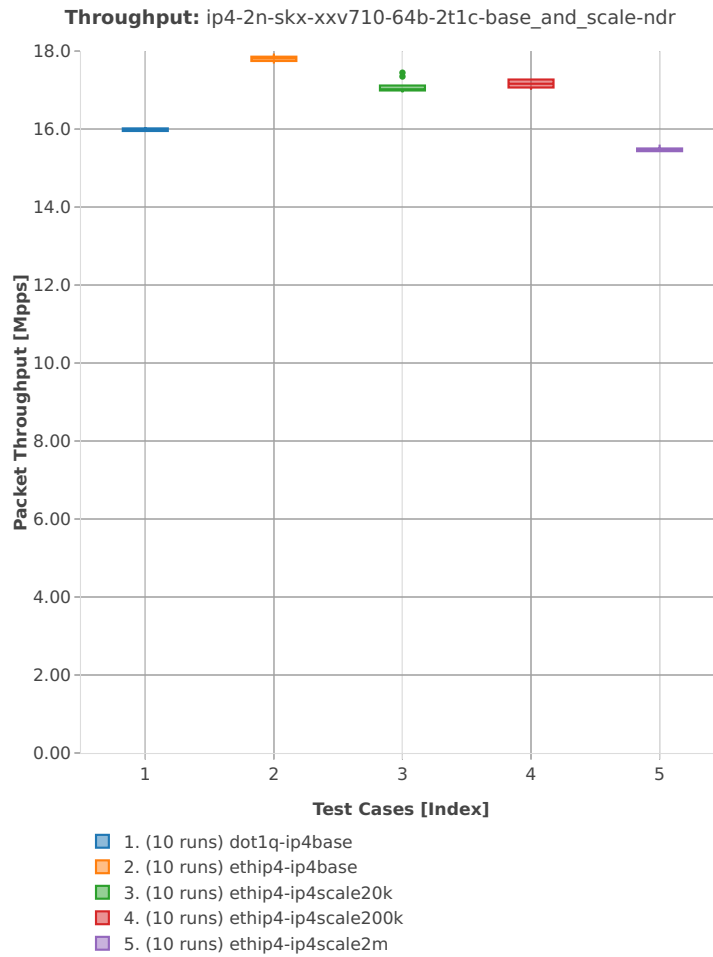

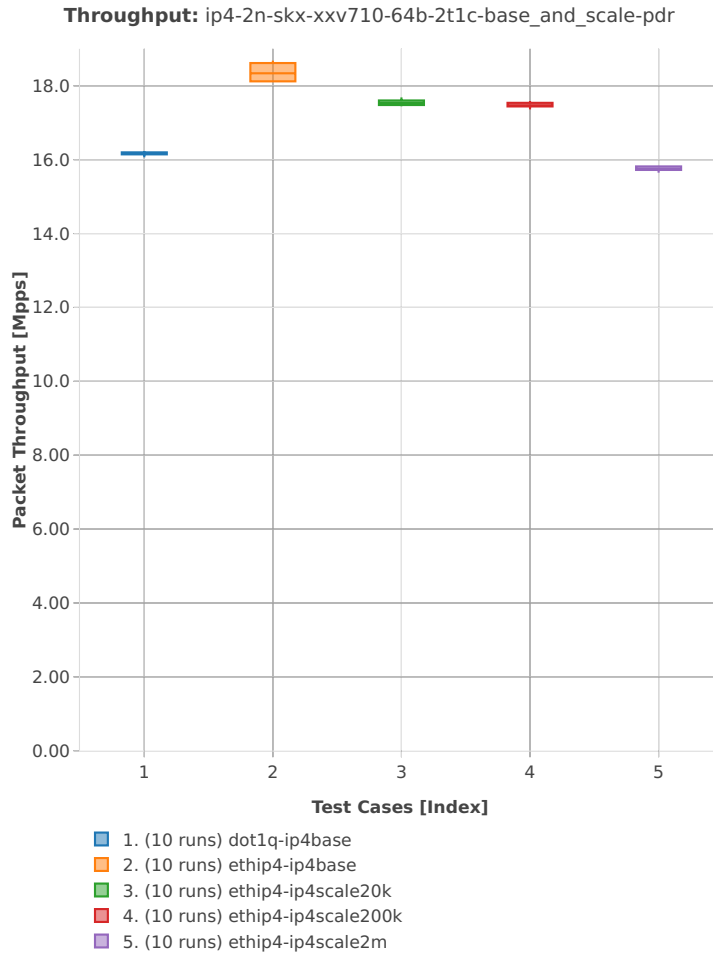

## 64b-4t2c-base\_and\_scale

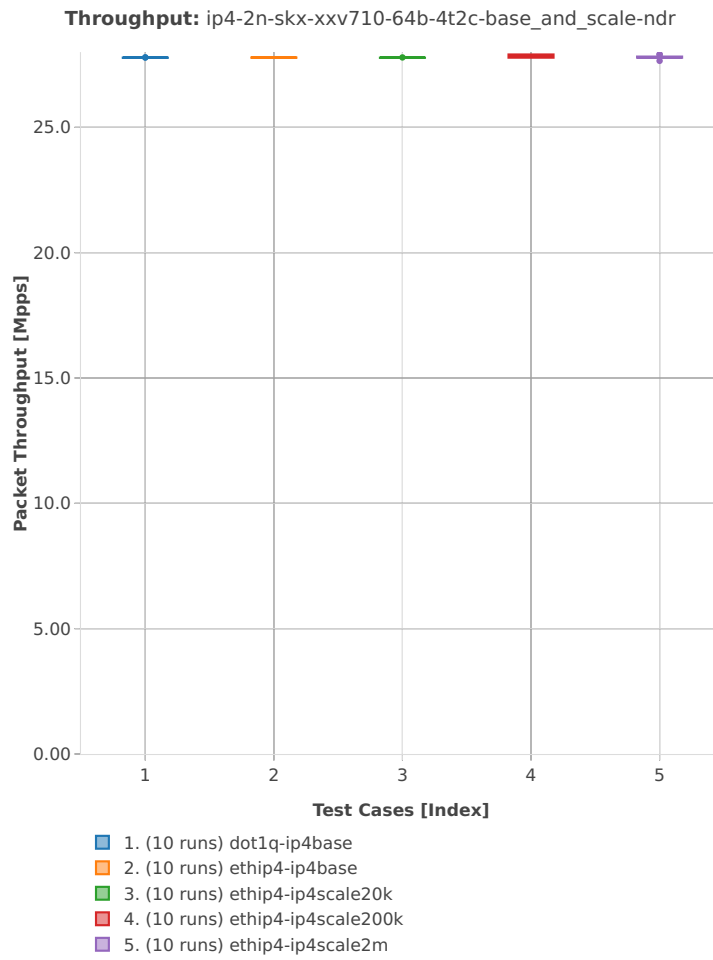

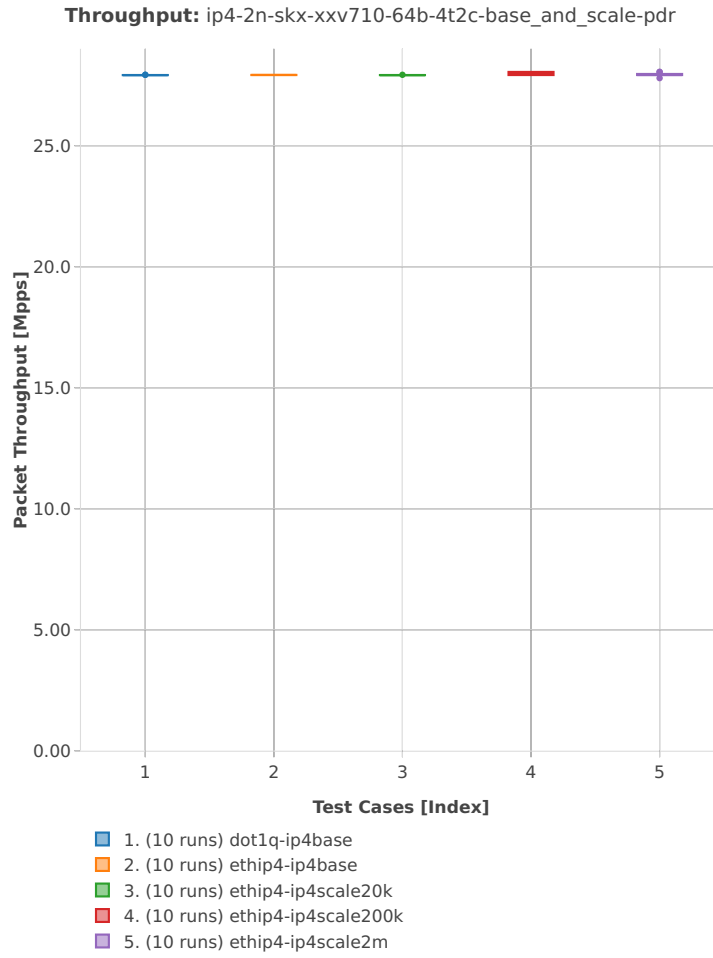

### 2.3.3 IPv6 Routing

Following sections include summary graphs of VPP Phy-to-Phy performance with IPv6 Routed-Forwarding, including NDR throughput (zero packet loss) and PDR throughput (<0.5% packet loss). Performance is reported for VPP running in multiple configurations of VPP worker thread(s), a.k.a. VPP data plane thread(s), and their physical CPU core(s) placement.

CSIT source code for the test cases used for plots can be found in [CSIT git repository](#)<sup>44</sup>.

---

<sup>44</sup> <https://git.fd.io/csit/tree/tests/vpp/perf/ip6?h=rls1901>

3n-hsw-x520

78b-1t1c-base\_and\_scale

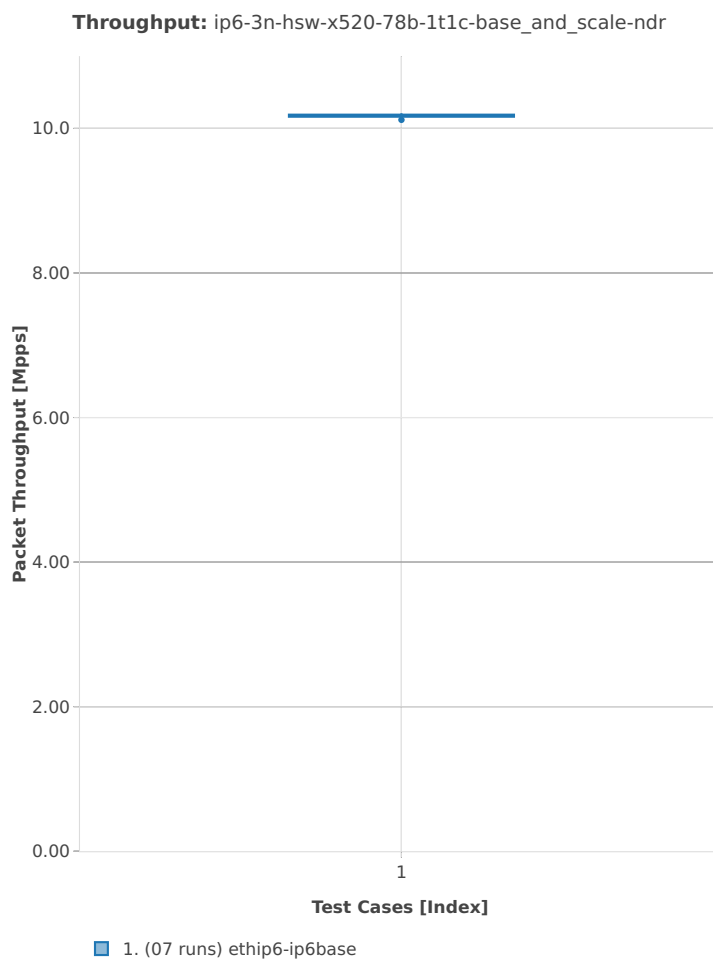

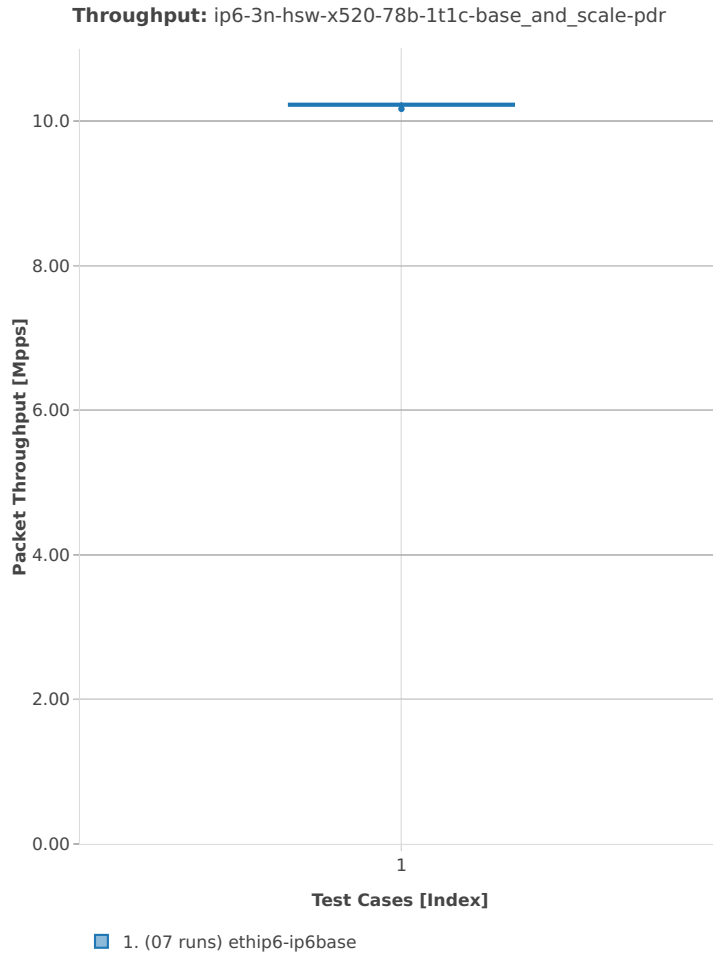



78b-2t2c-base\_and\_scale

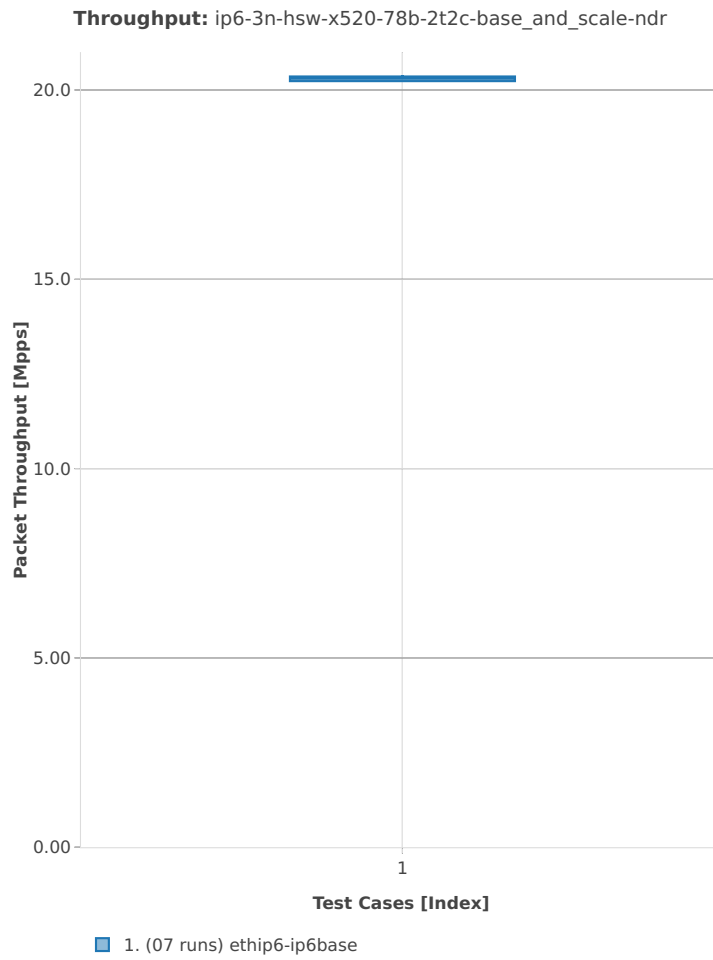

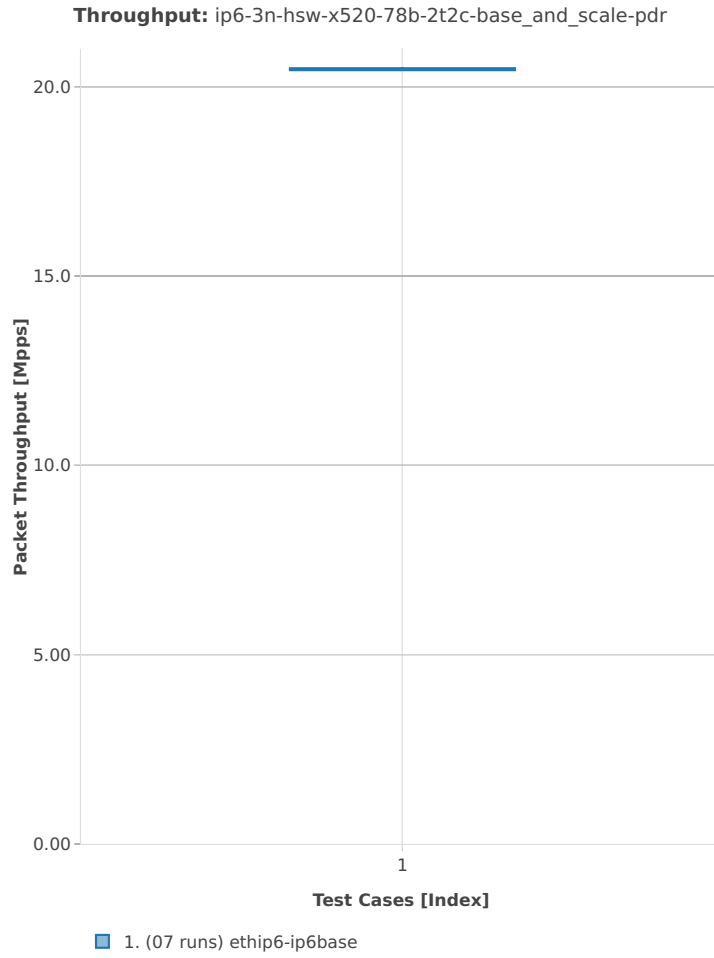

## 78b-1t1c-base\_and\_features

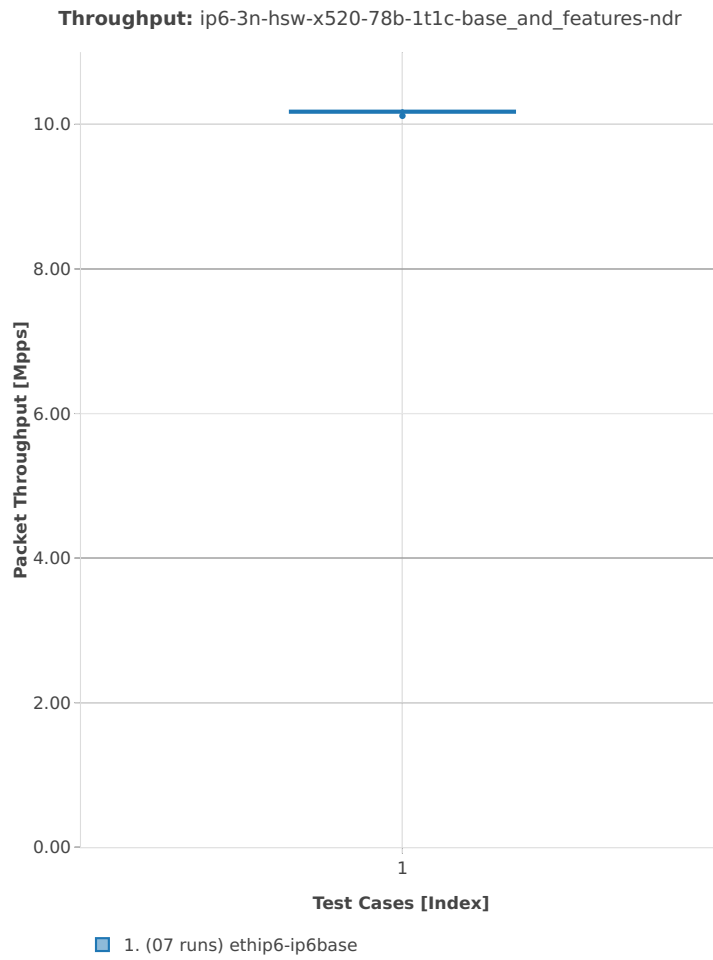

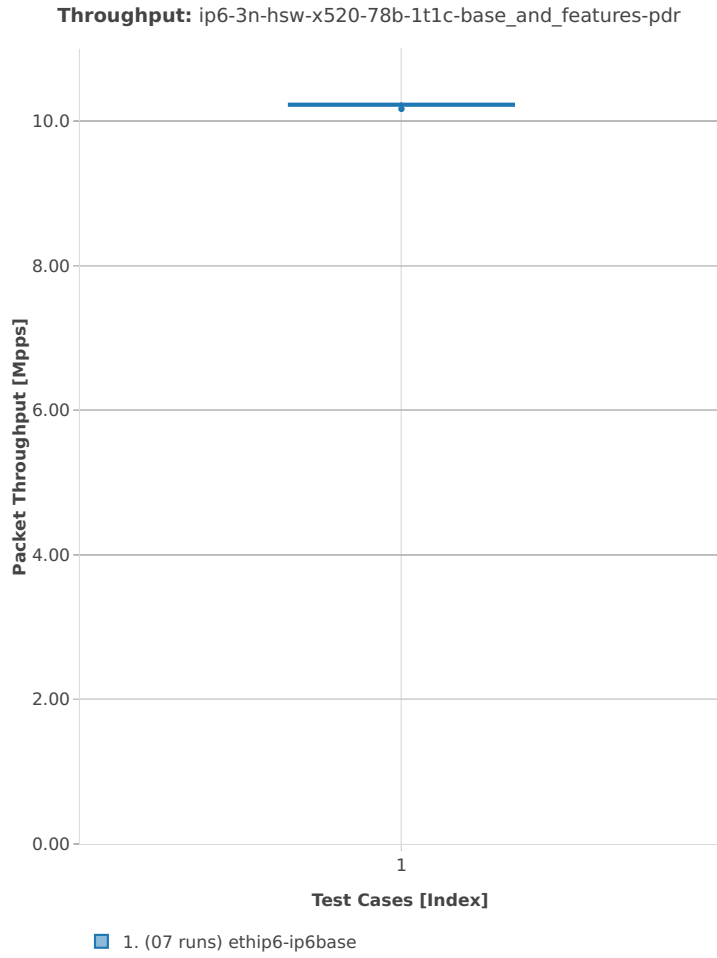

78b-2t2c-base\_and\_features

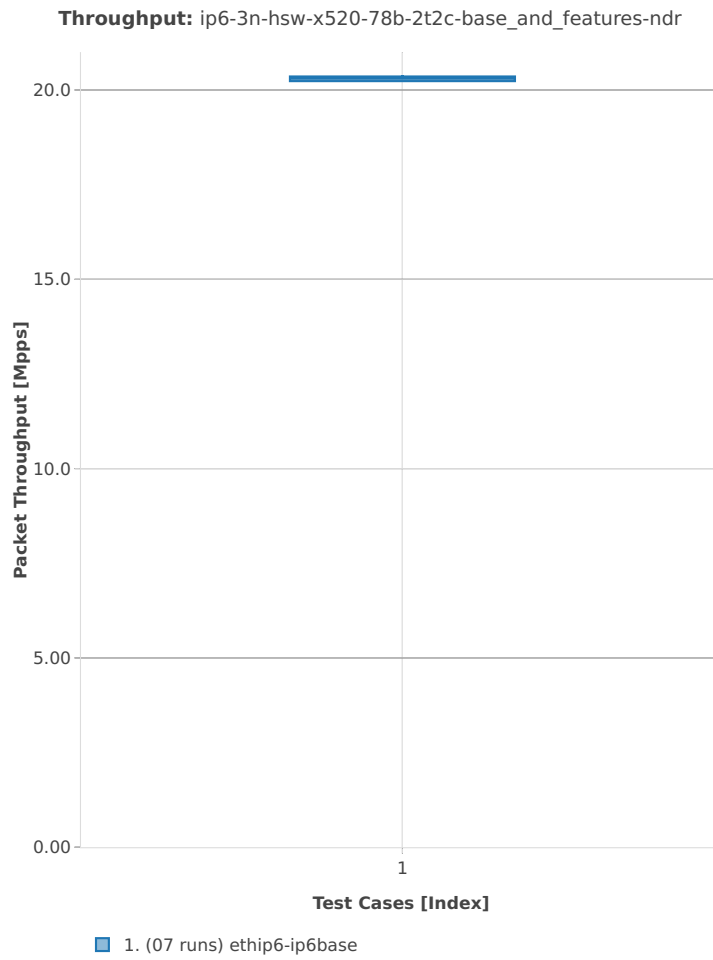

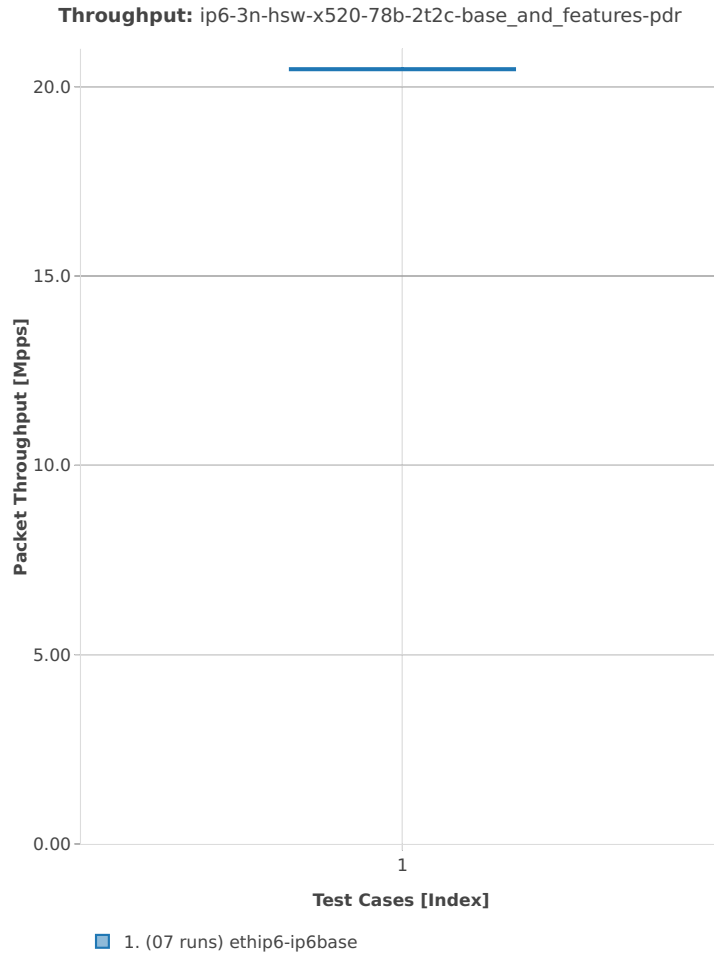

3n-hsw-x710

78b-1t1c-base\_and\_scale

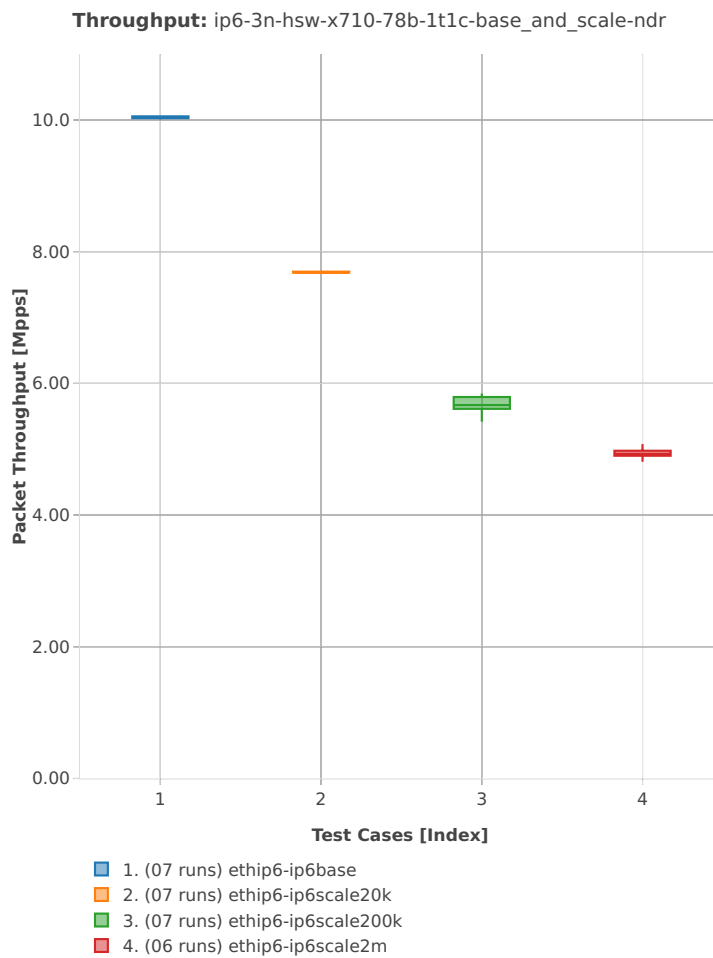

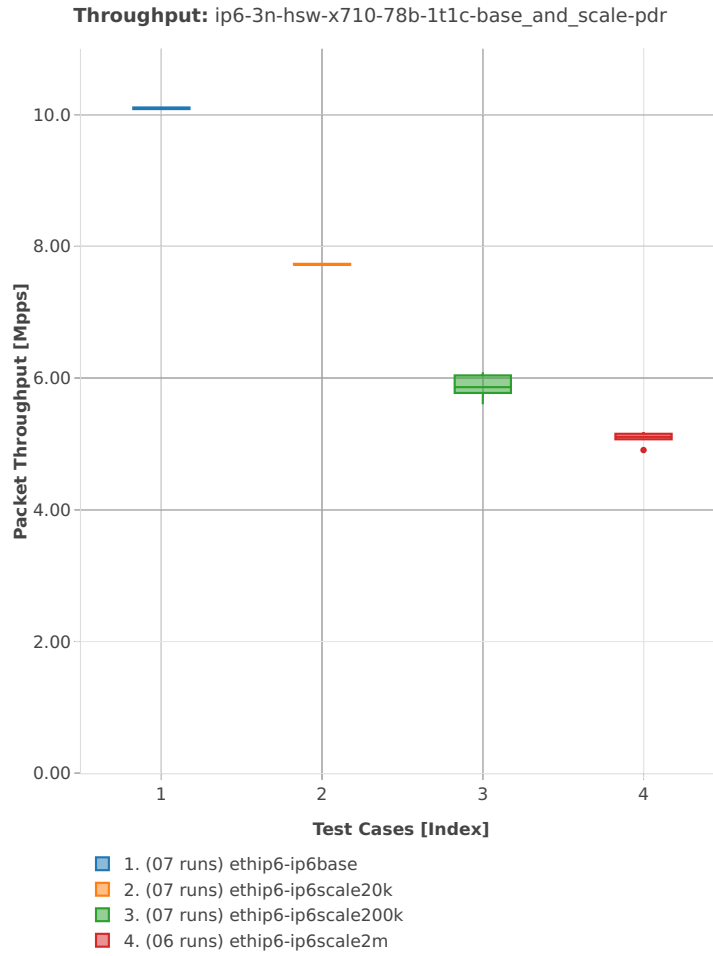



78b-2t2c-base\_and\_scale

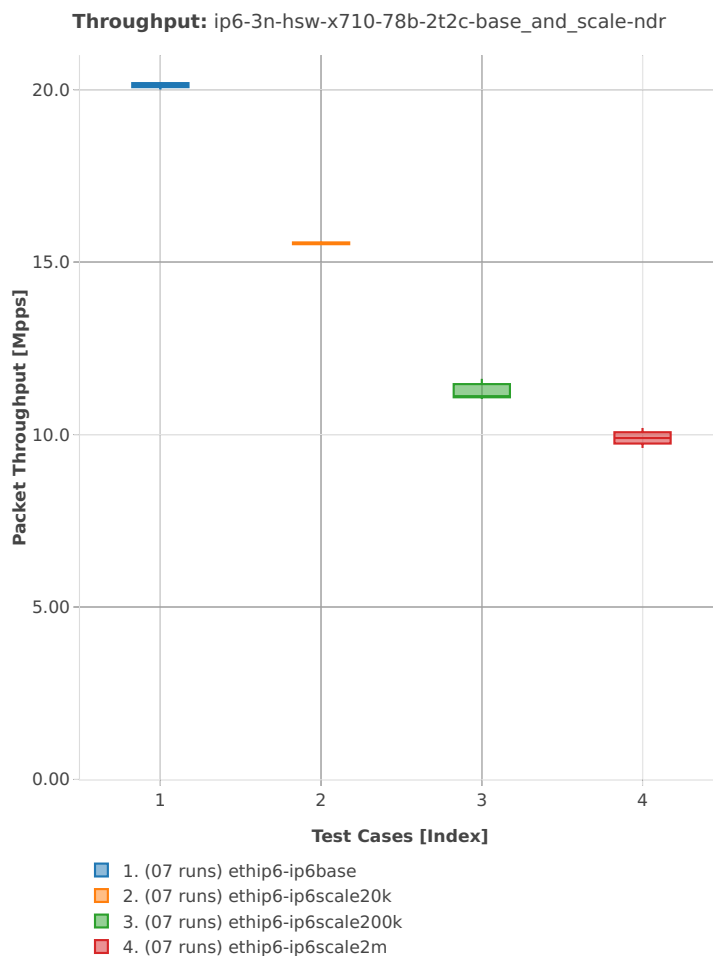

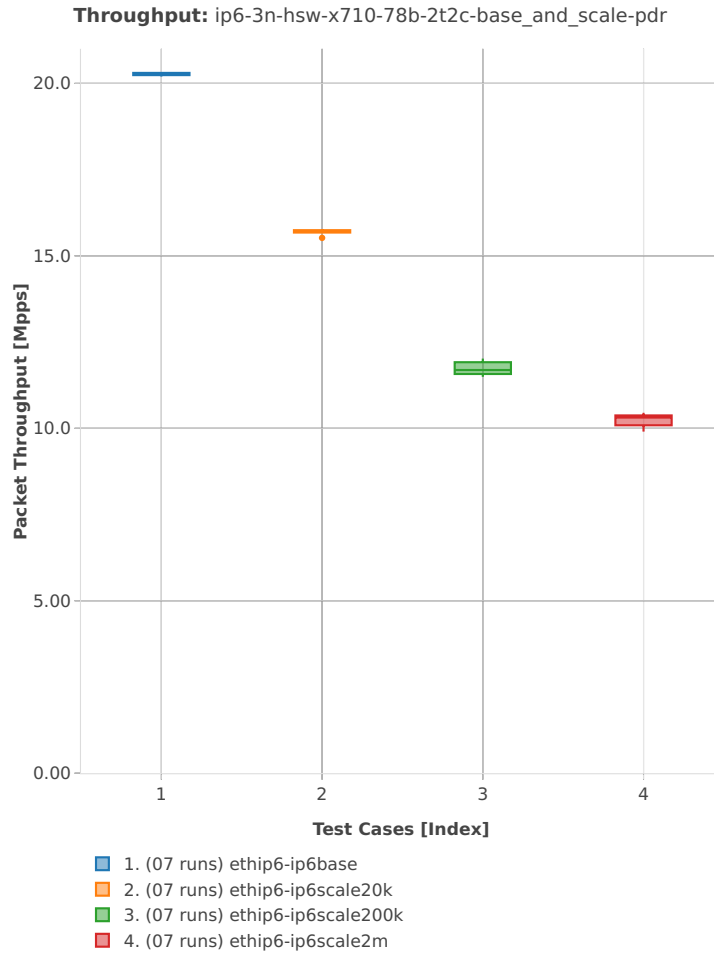

78b-1t1c-base\_and\_features

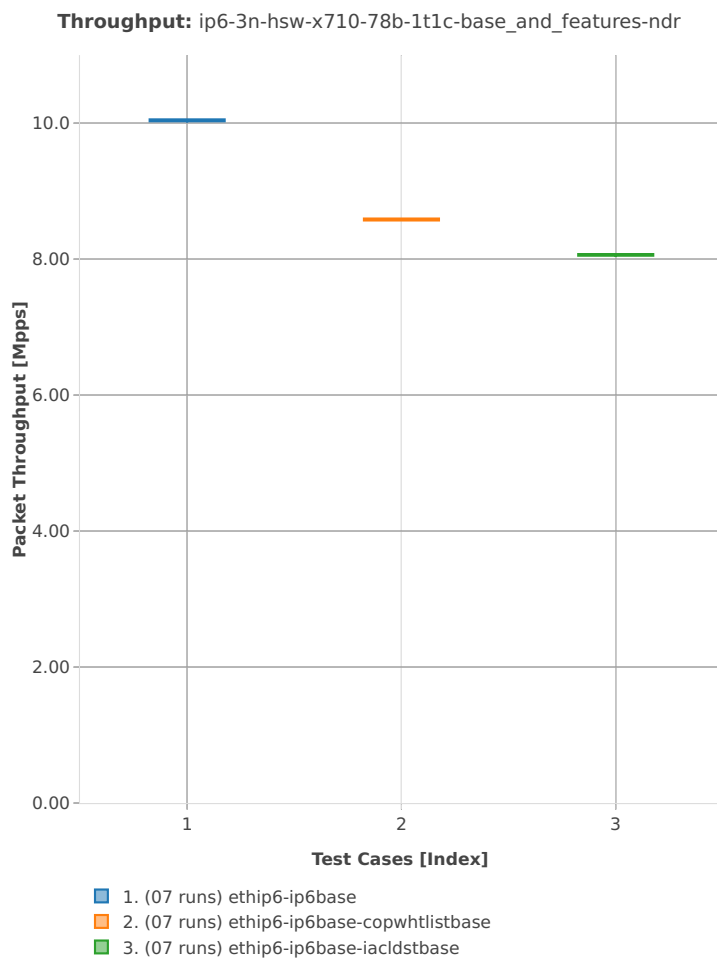

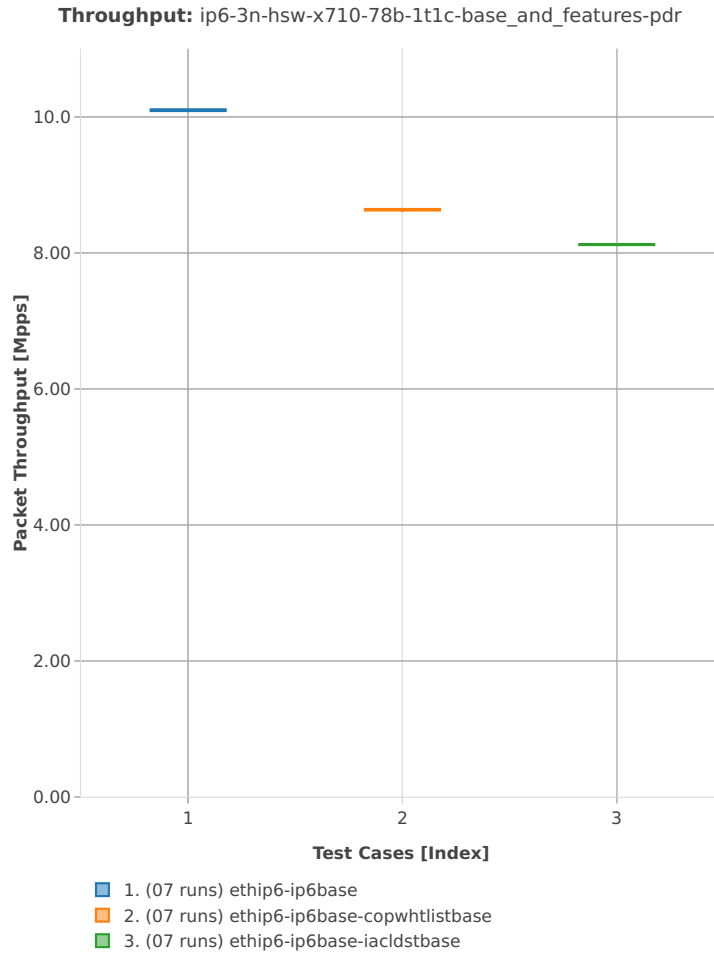

78b-2t2c-base\_and\_features

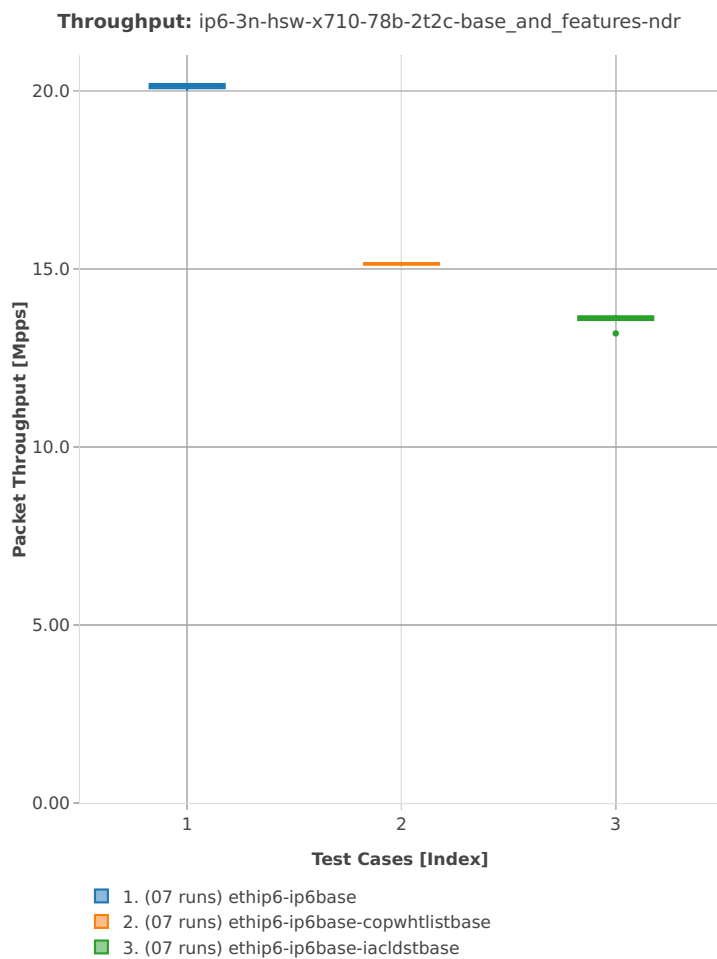

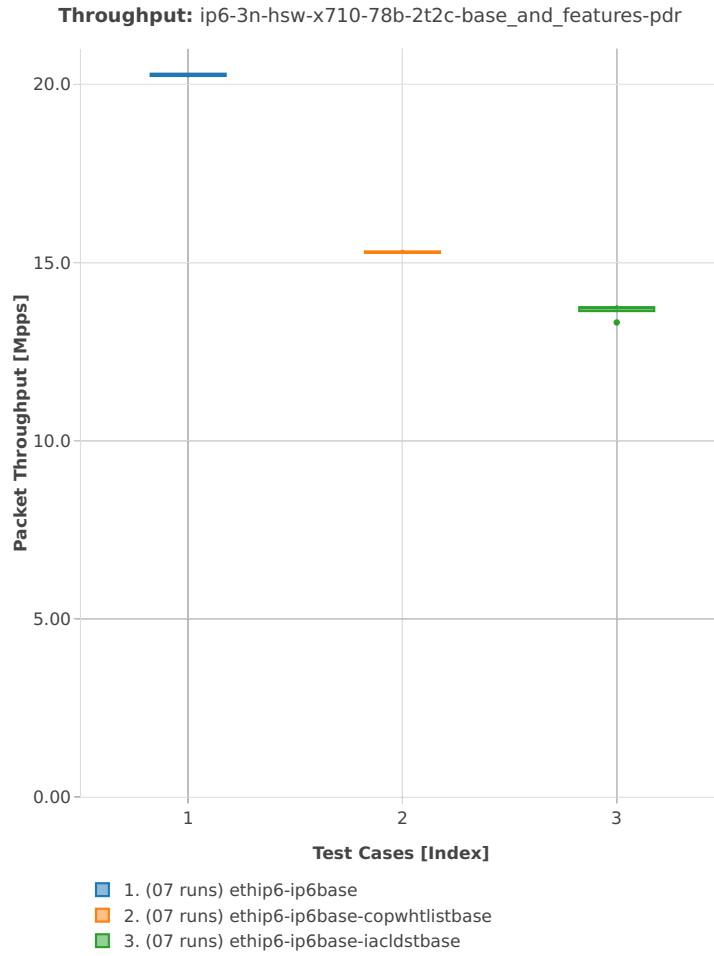

3n-hsw-xl710

78b-1t1c-base\_and\_scale

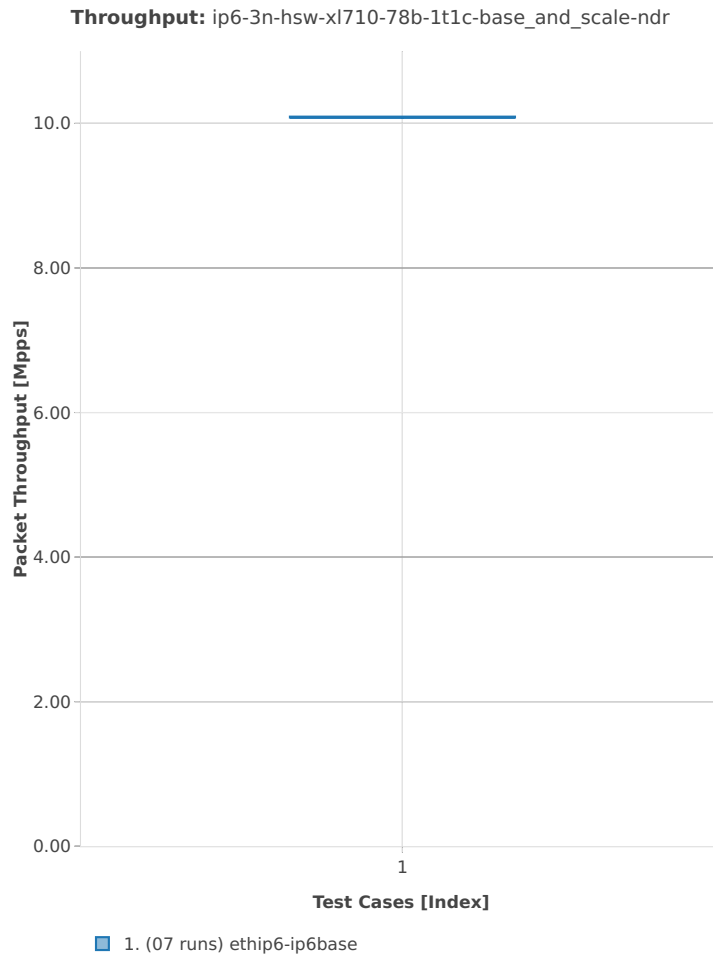

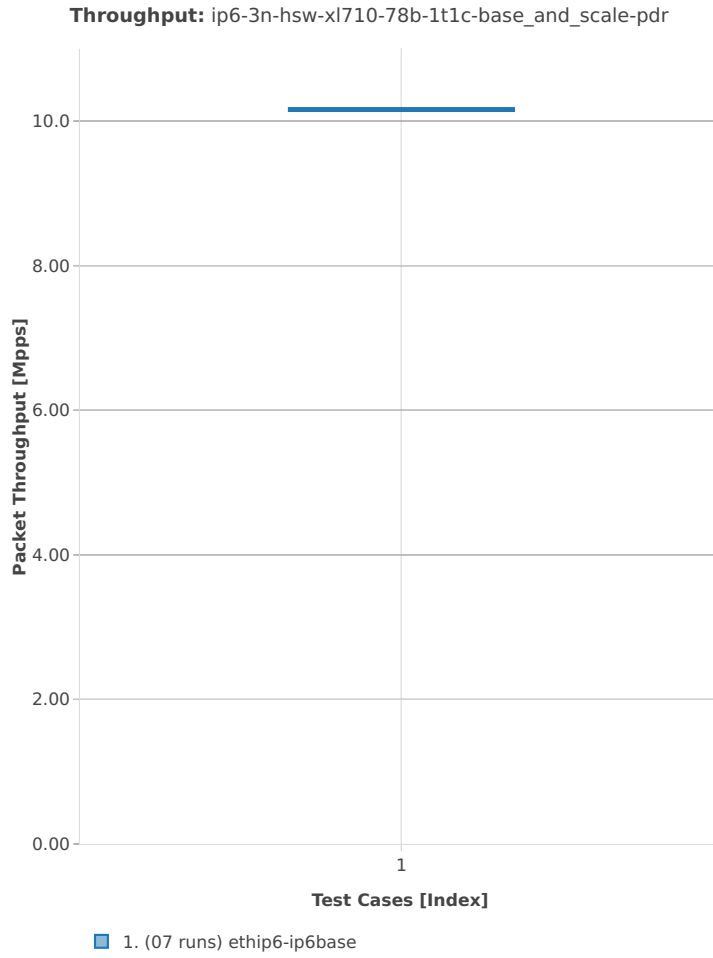



### 78b-2t2c-base\_and\_scale

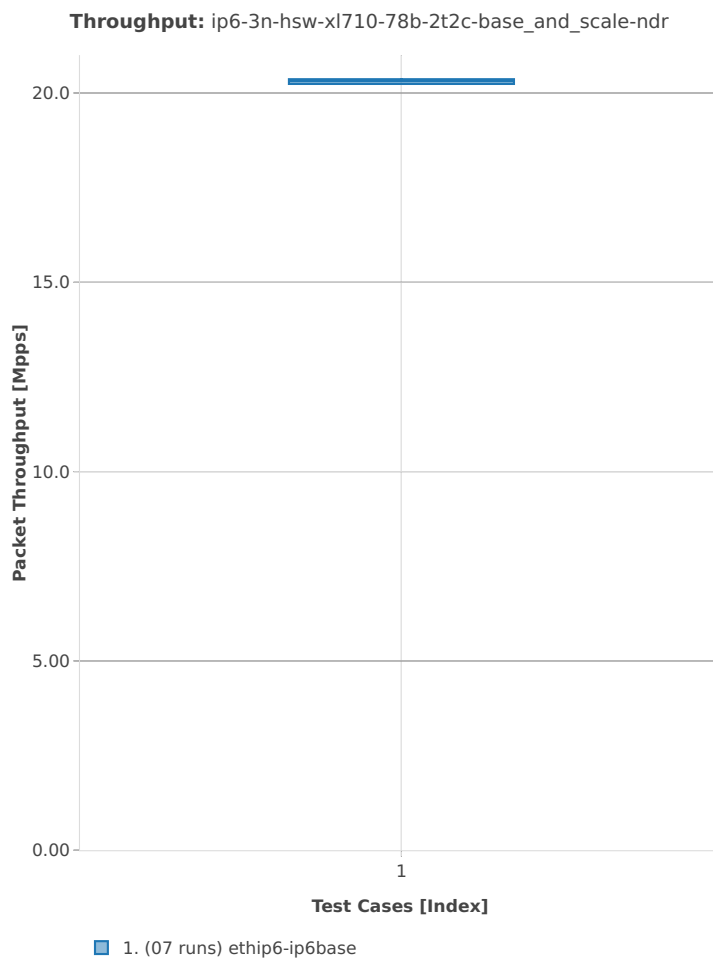

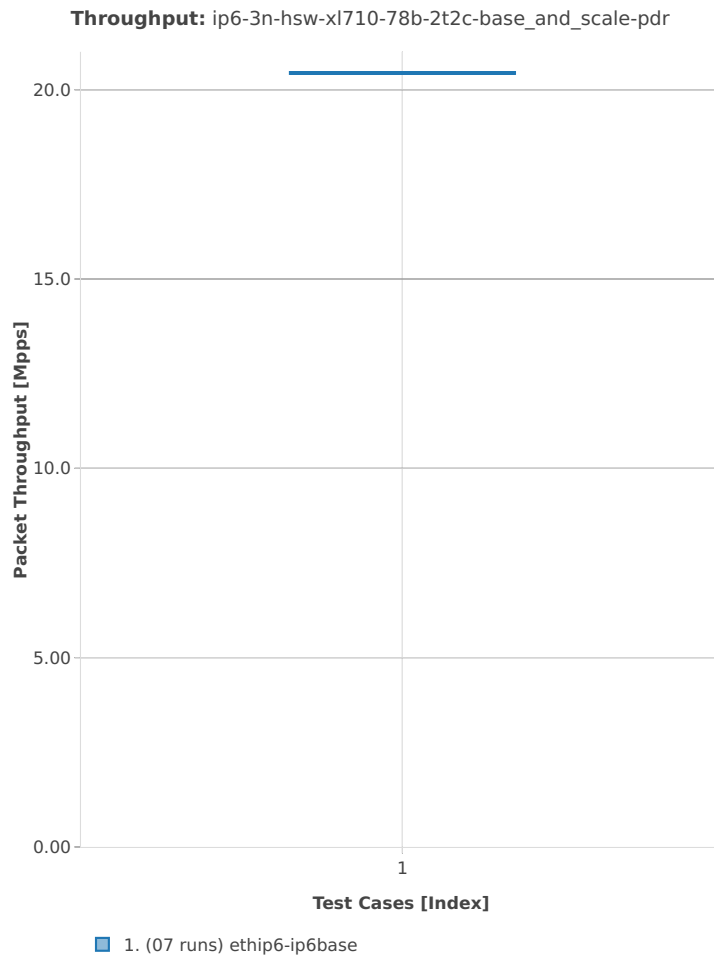

3n-skx-x710

78b-2t1c-base\_and\_scale

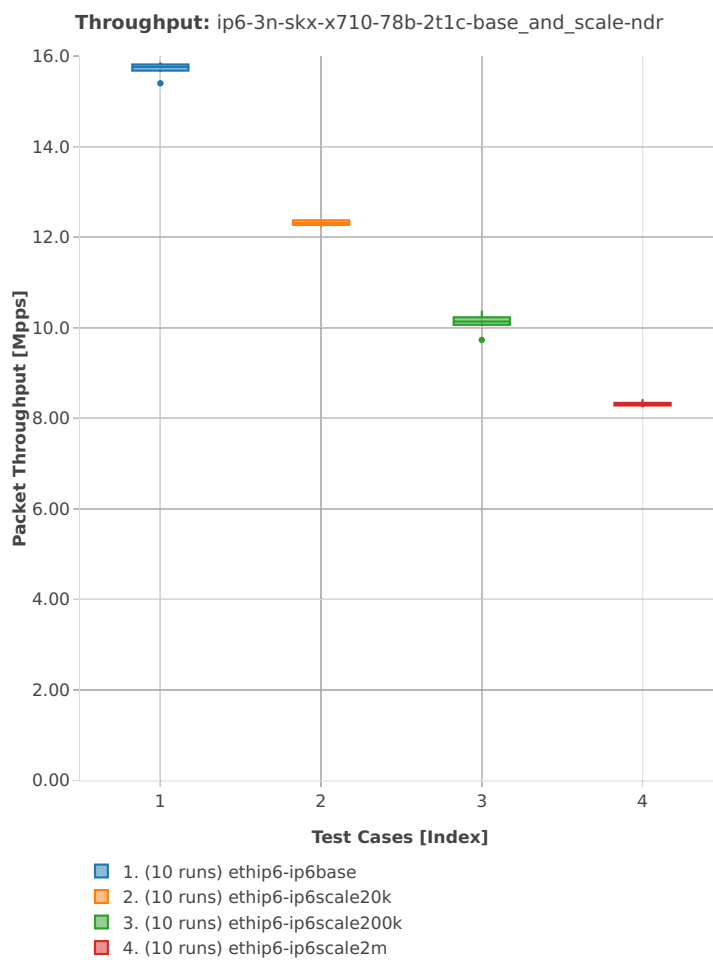

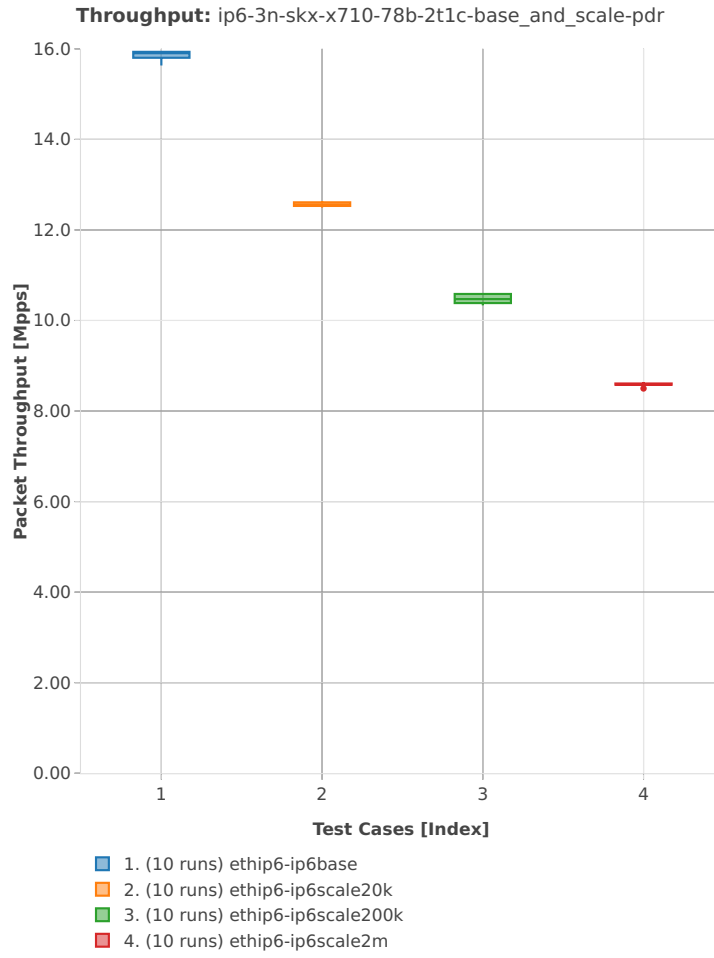

78b-4t2c-base\_and\_scale

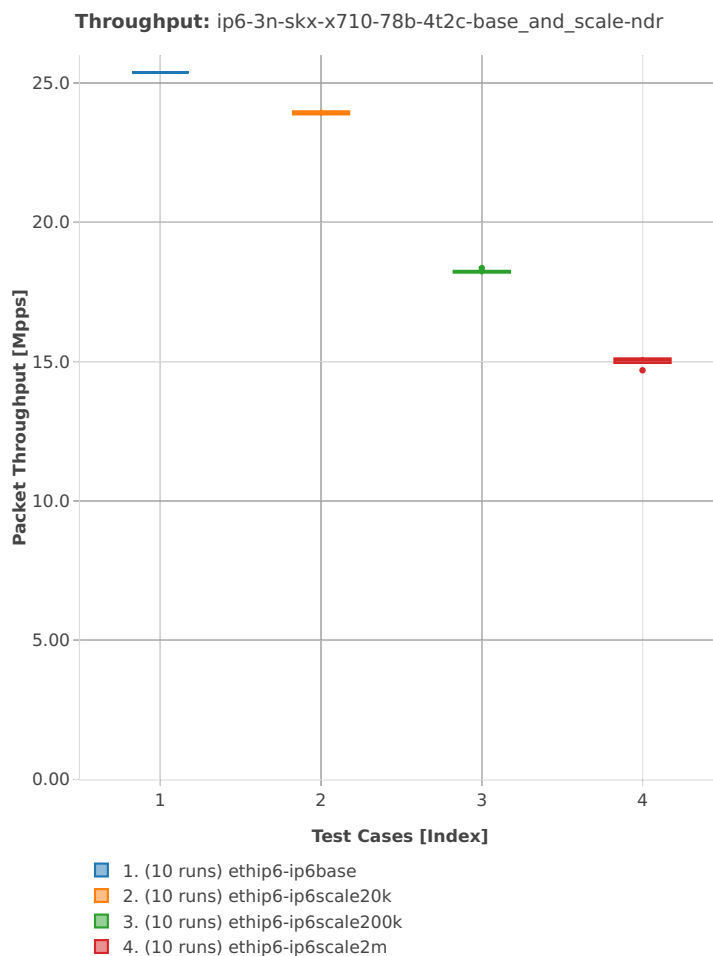

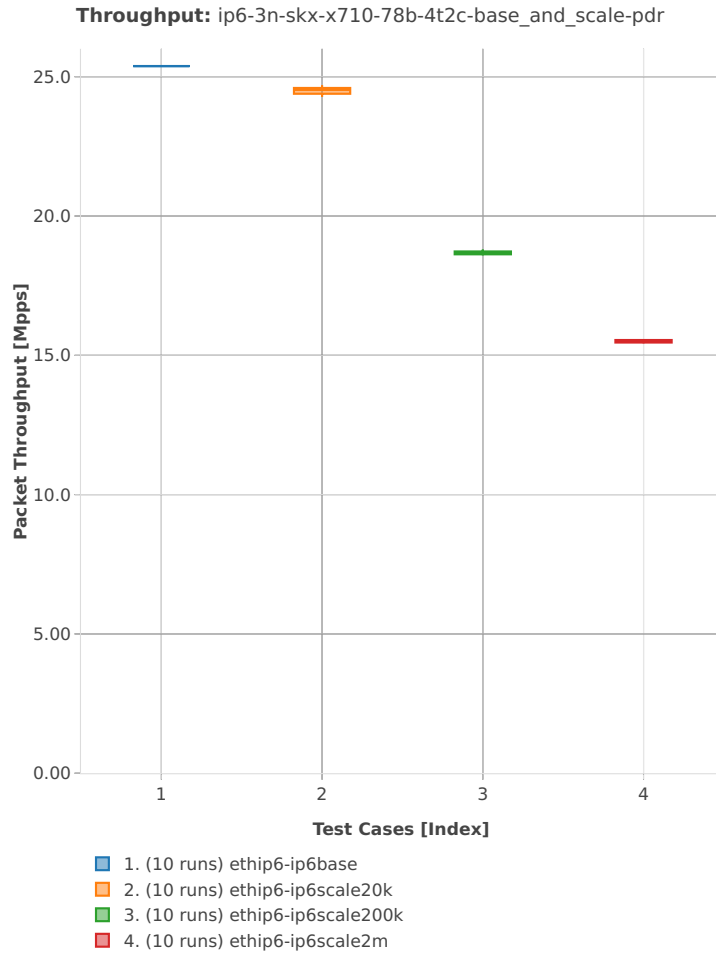

78b-2t1c-base\_and\_features

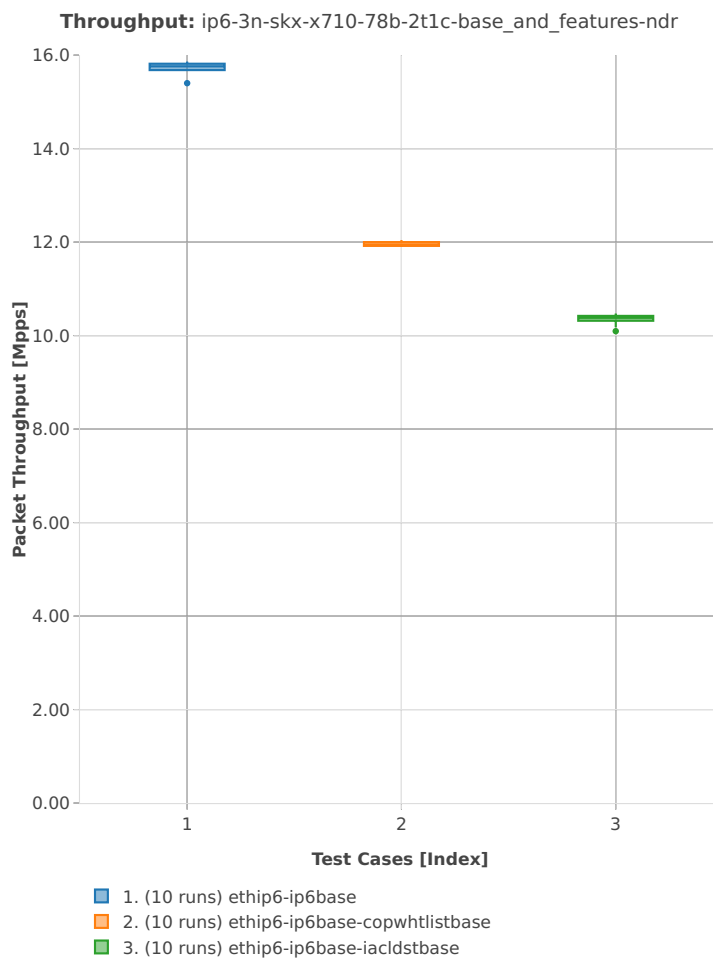

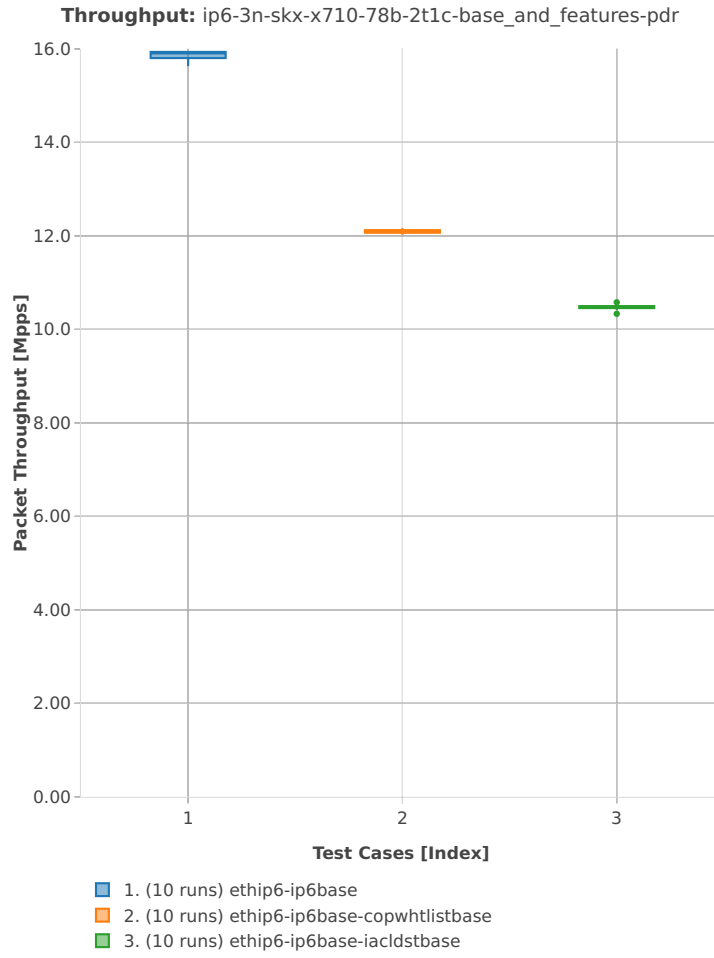



78b-4t2c-base\_and\_features

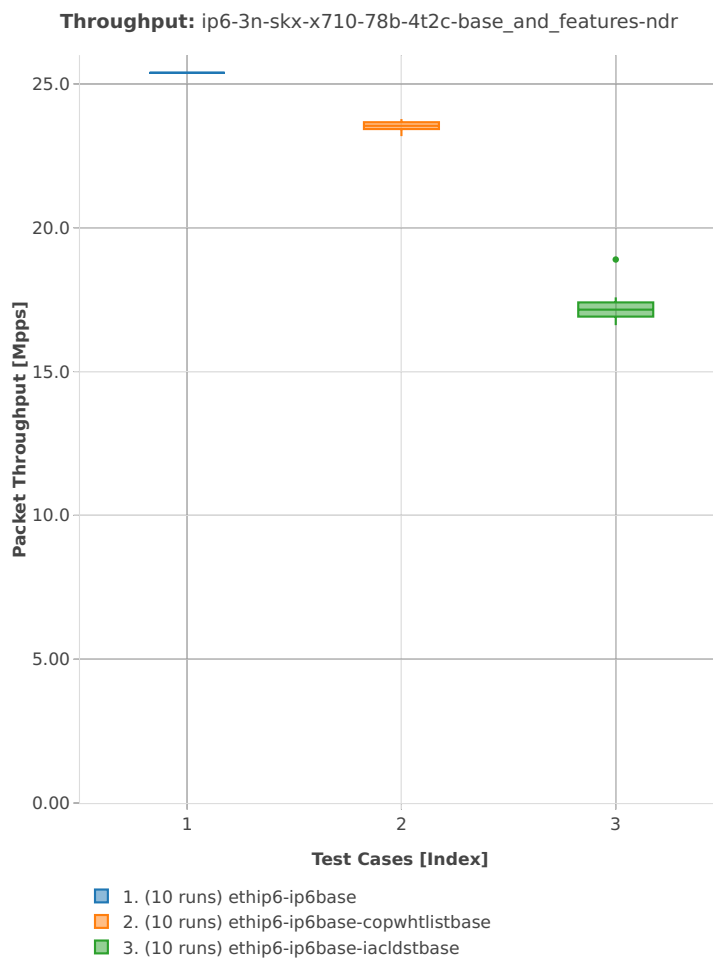

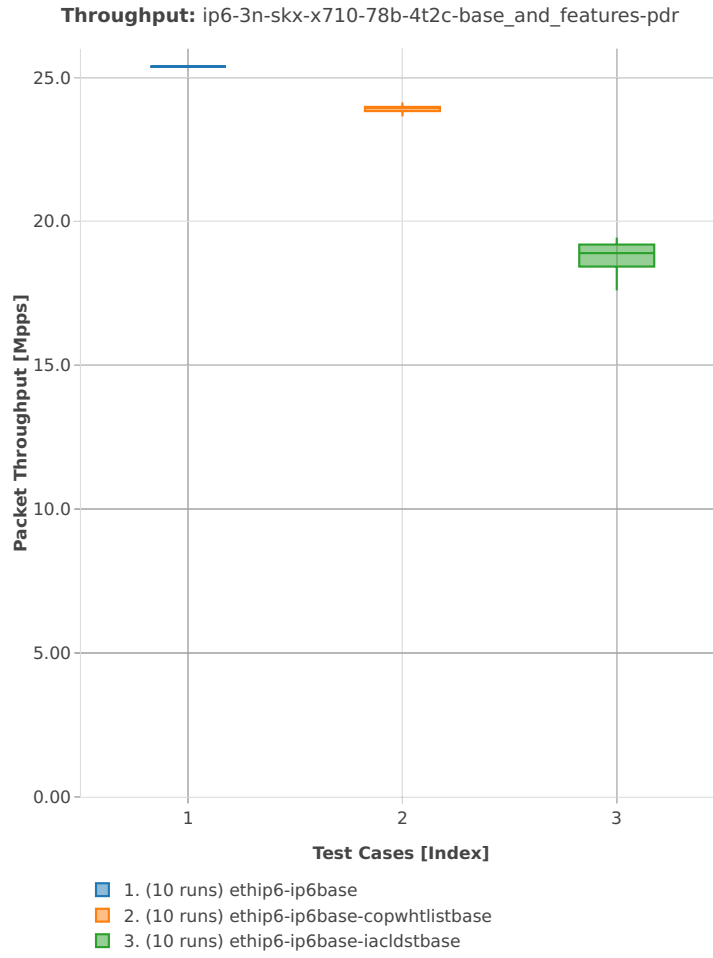

2n-skx-x710

78b-2t1c-base\_and\_scale

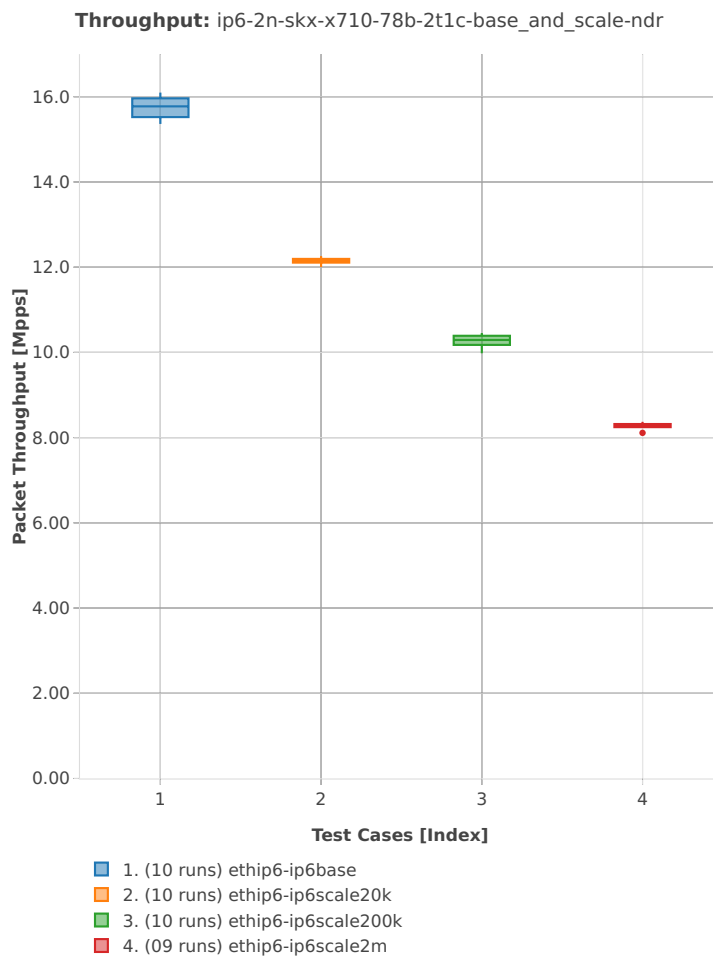

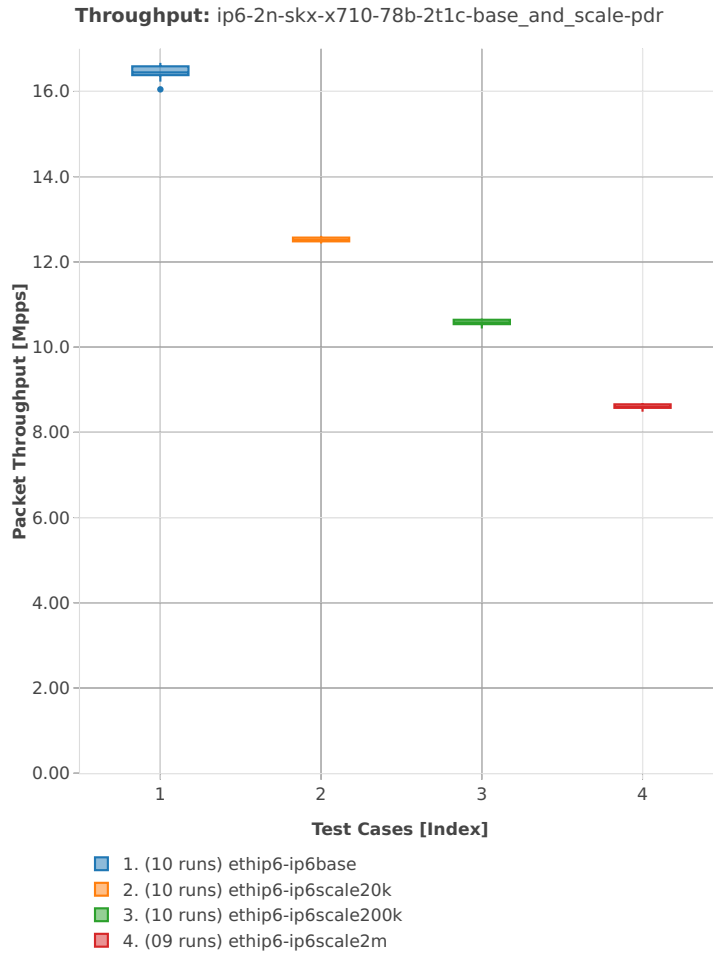

78b-4t2c-base\_and\_scale

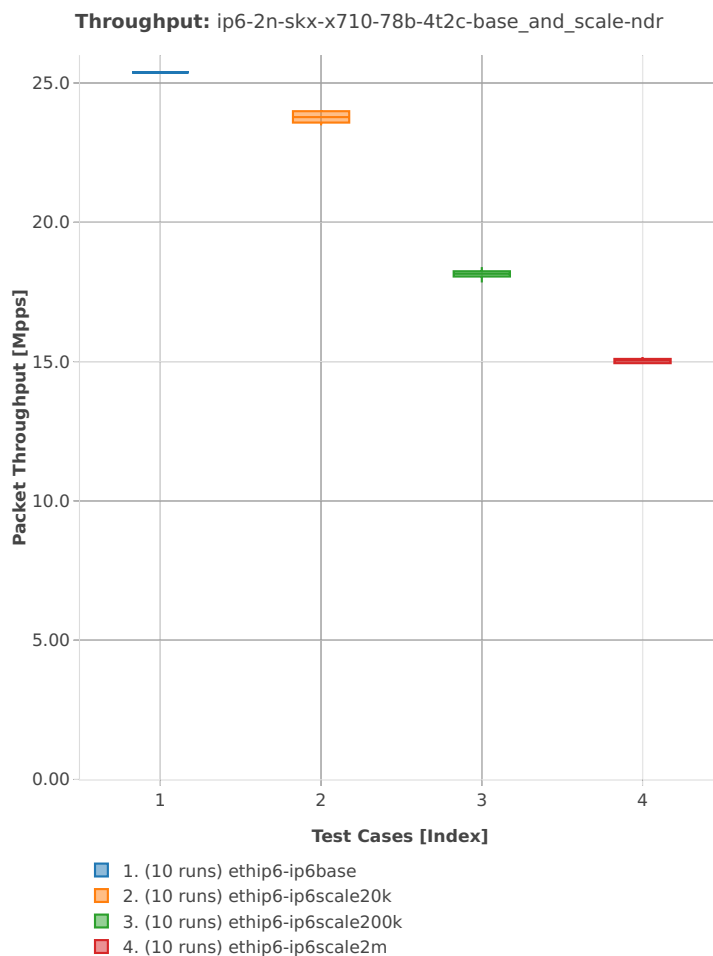

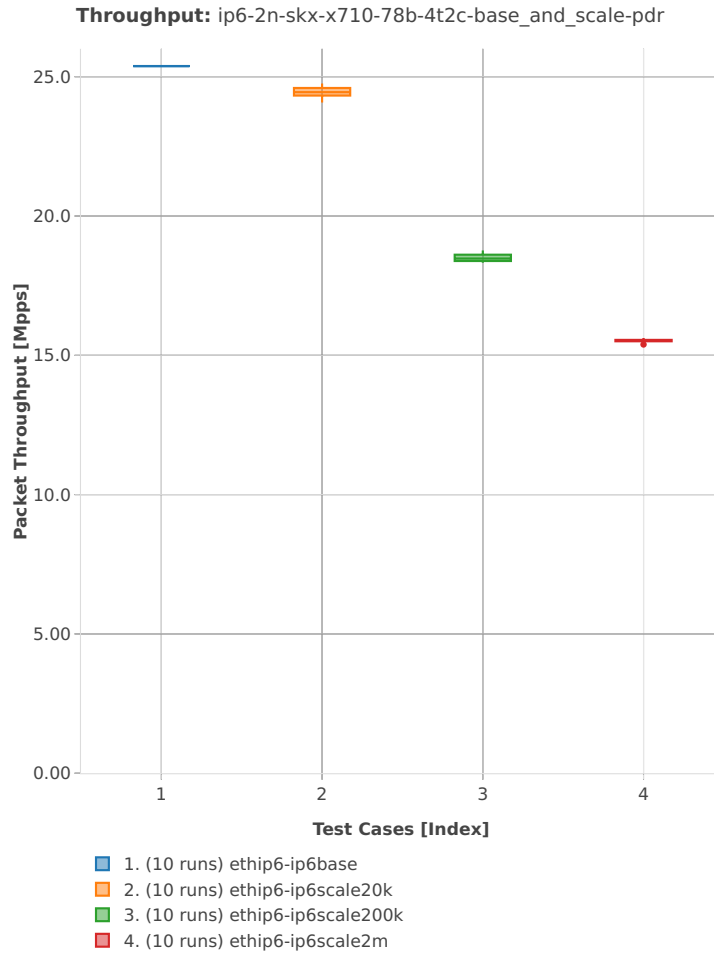

2n-skx-xxv710

78b-2t1c-base\_and\_scale

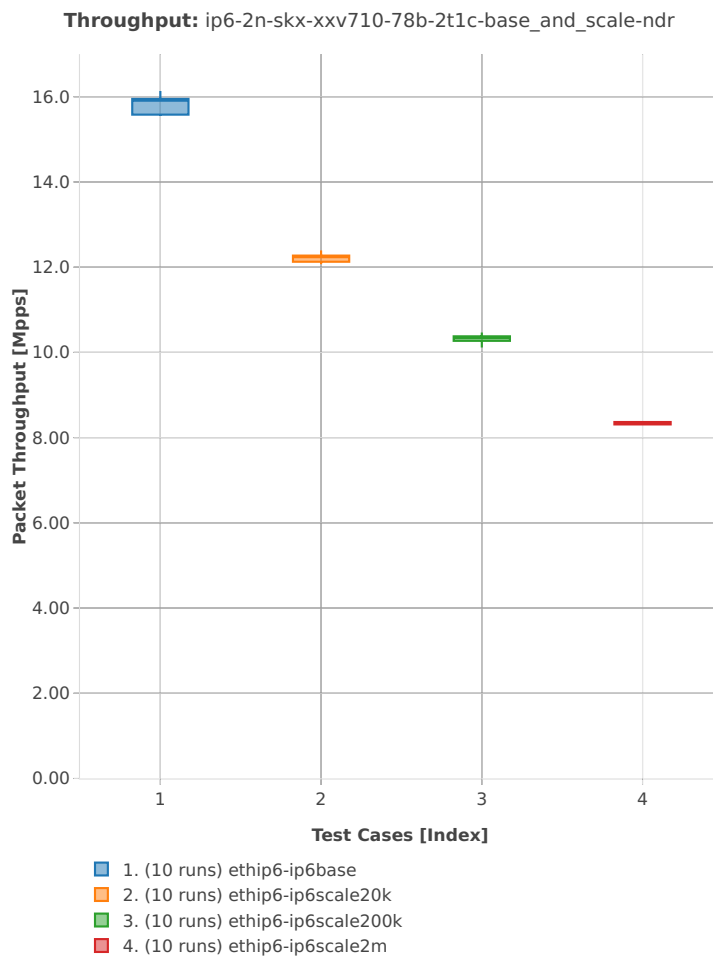

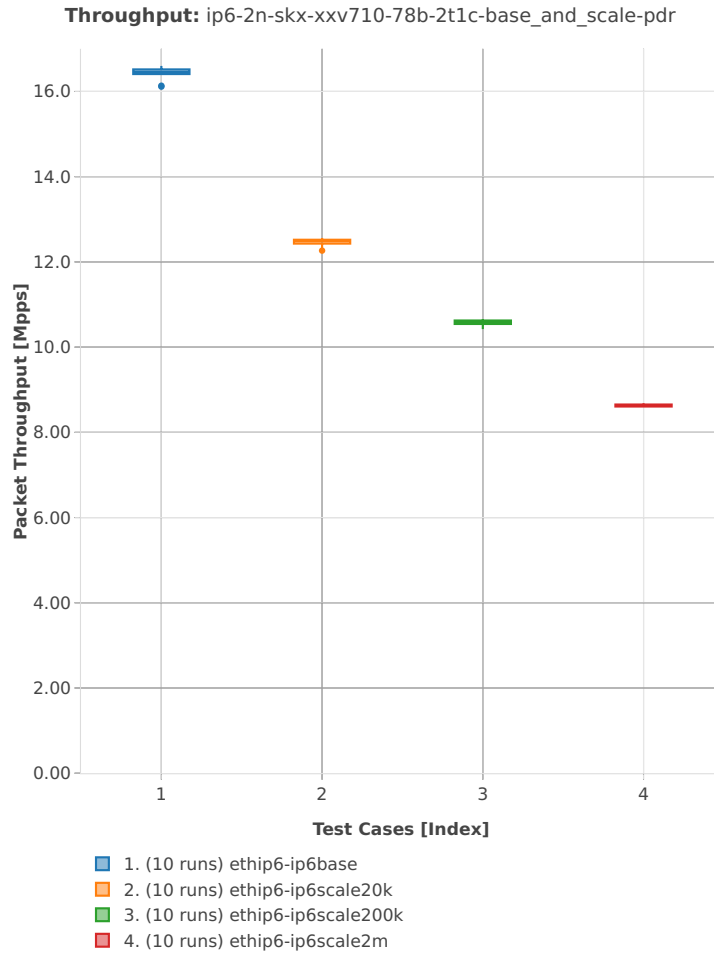



78b-4t2c-base\_and\_scale

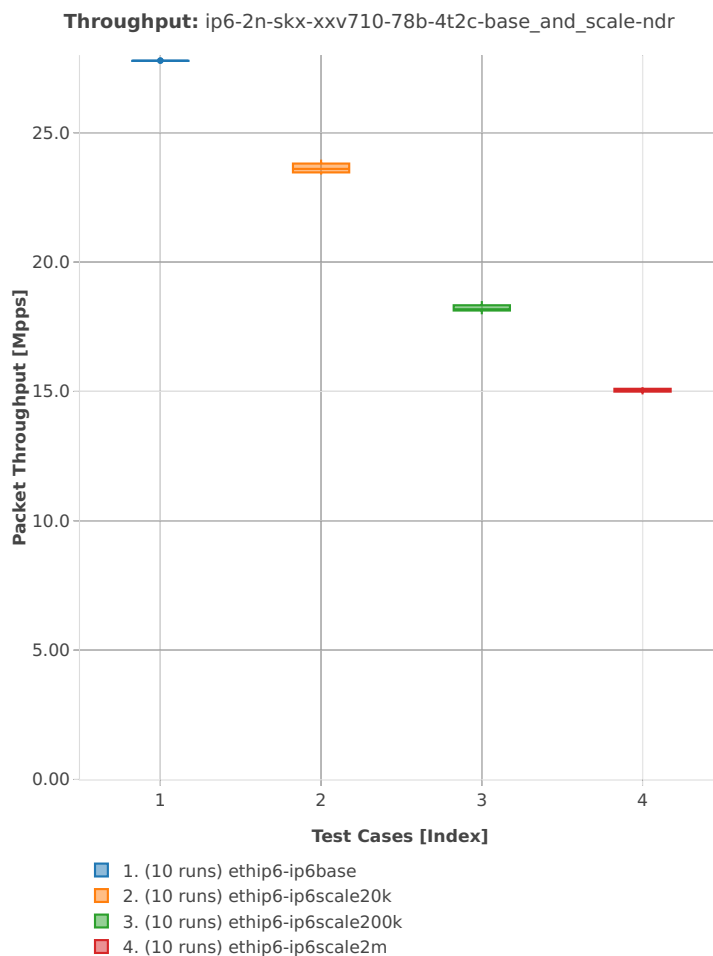

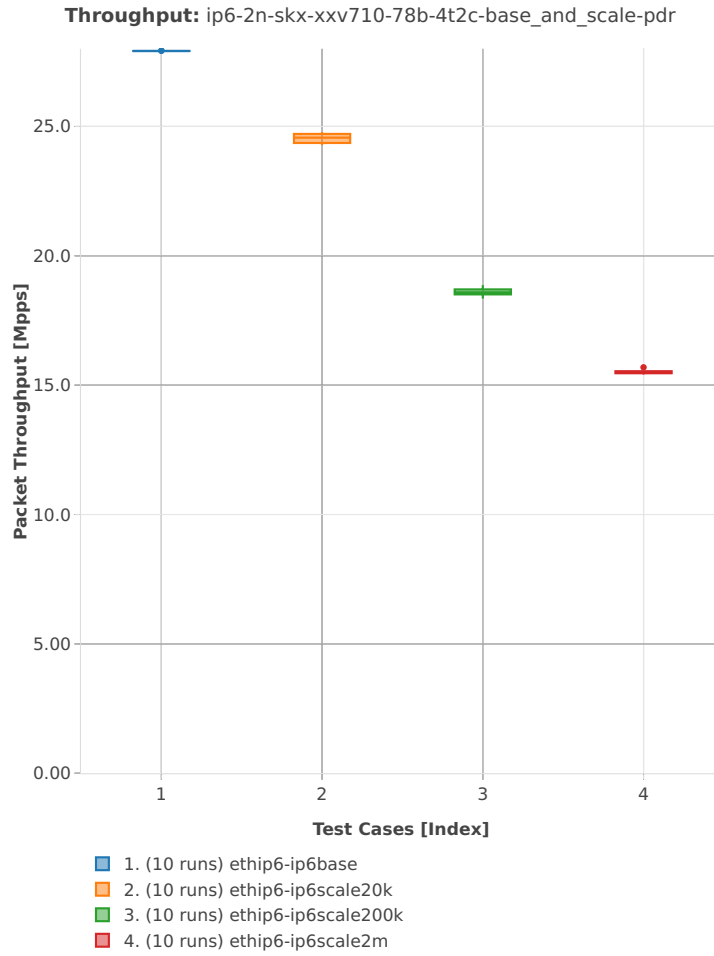

### 2.3.4 SRv6 Routing

Following sections include summary graphs of VPP Phy-to-Phy performance with SRv6, including NDR throughput (zero packet loss) and PDR throughput (<0.5% packet loss). Performance is reported for VPP running in multiple configurations of VPP worker thread(s), a.k.a. VPP data plane thread(s), and their physical CPU core(s) placement.

CSIT source code for the test cases used for plots can be found in [CSIT git repository](#)<sup>45</sup>.

---

<sup>45</sup> <https://git.fd.io/csit/tree/tests/vpp/perf/srv6?h=rls1901>

3n-hsw-x520

78b-1t1c-features

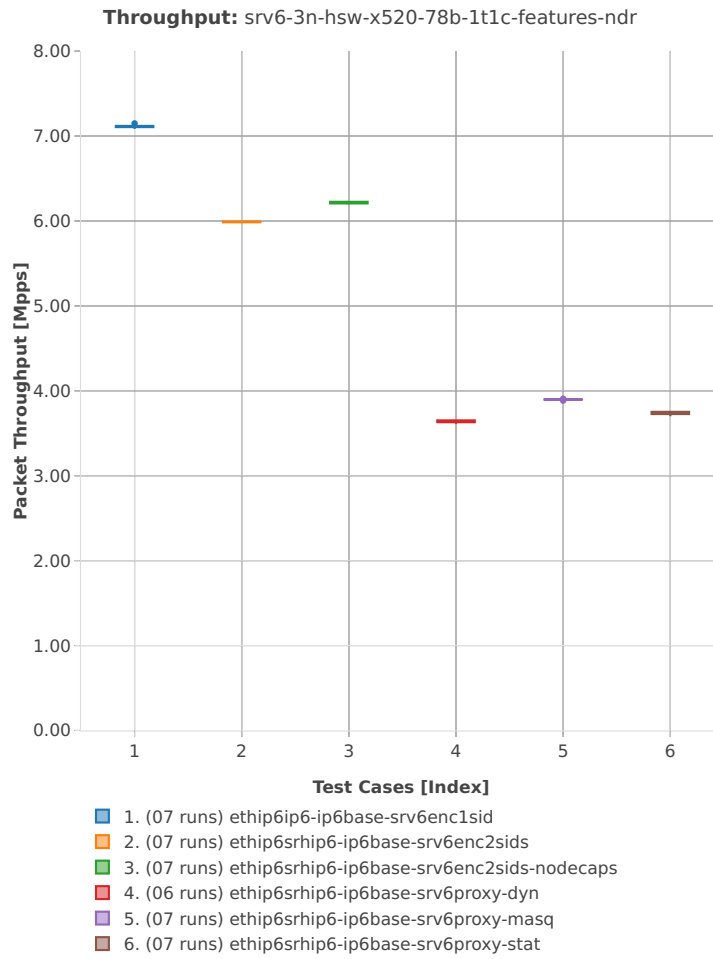

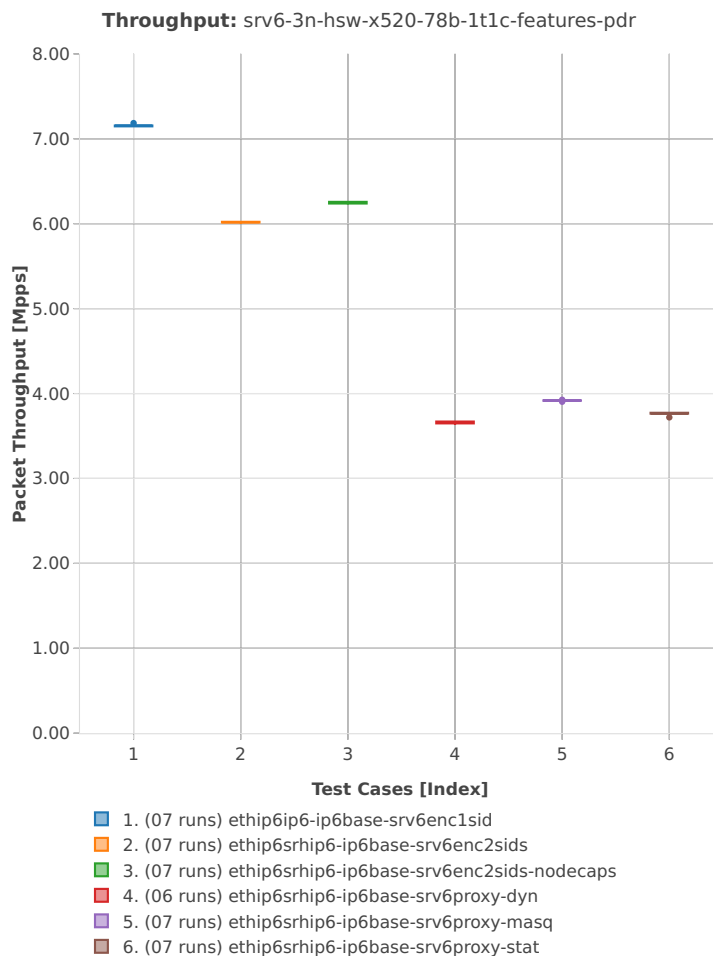

78b-2t2c-features

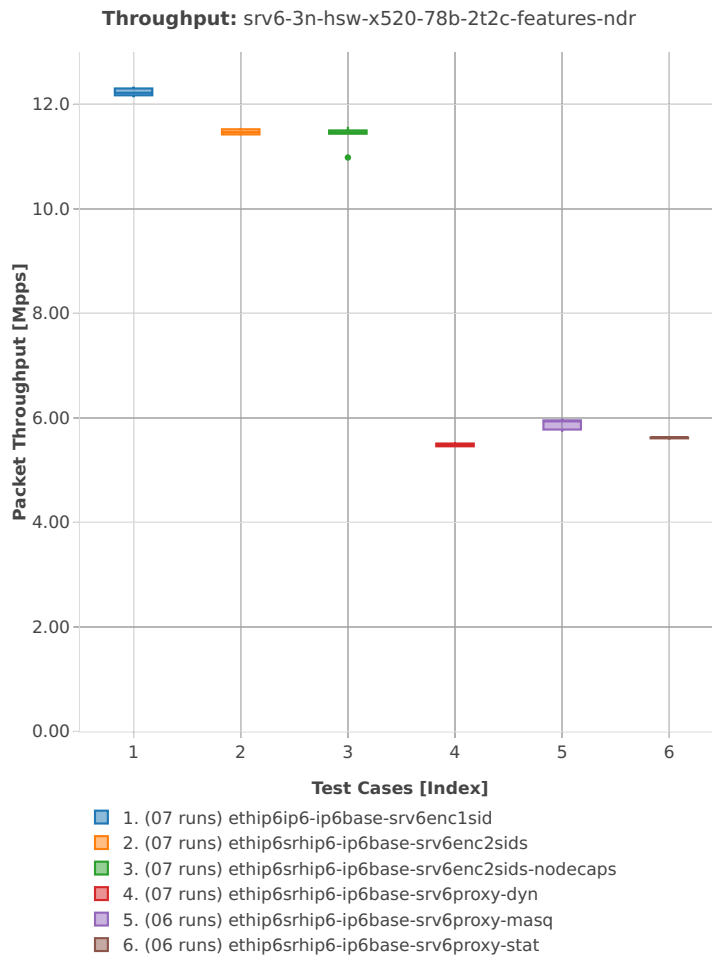

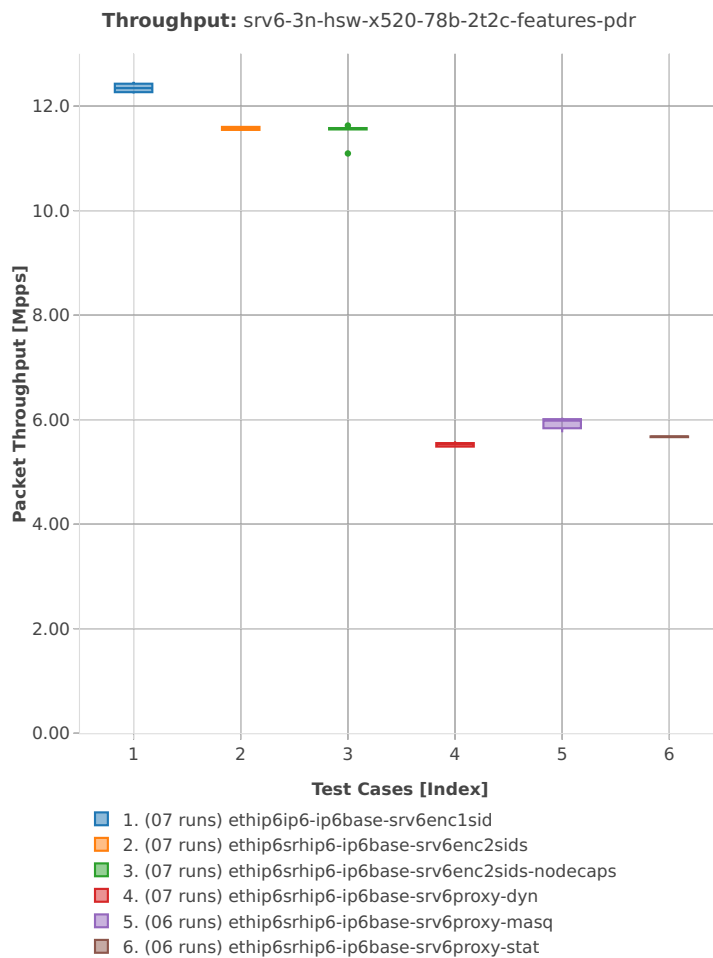

### 2.3.5 IPv4 Tunnels

Following sections include summary graphs of VPP Phy-to-Phy performance with IPv4 Overlay Tunnels, including NDR throughput (zero packet loss) and PDR throughput (<0.5% packet loss). Performance is reported for VPP running in multiple configurations of VPP worker thread(s), a.k.a. VPP data plane thread(s), and their physical CPU core(s) placement.

CSIT source code for the test cases used for plots can be found in [CSIT git repository](#)<sup>46</sup>.

---

<sup>46</sup> [https://git.fd.io/csit/tree/tests/vpp/perf/ip4\\_tunnels?h=rls1901](https://git.fd.io/csit/tree/tests/vpp/perf/ip4_tunnels?h=rls1901)



3n-hsw-x520

64b-1t1c-base\_and\_features

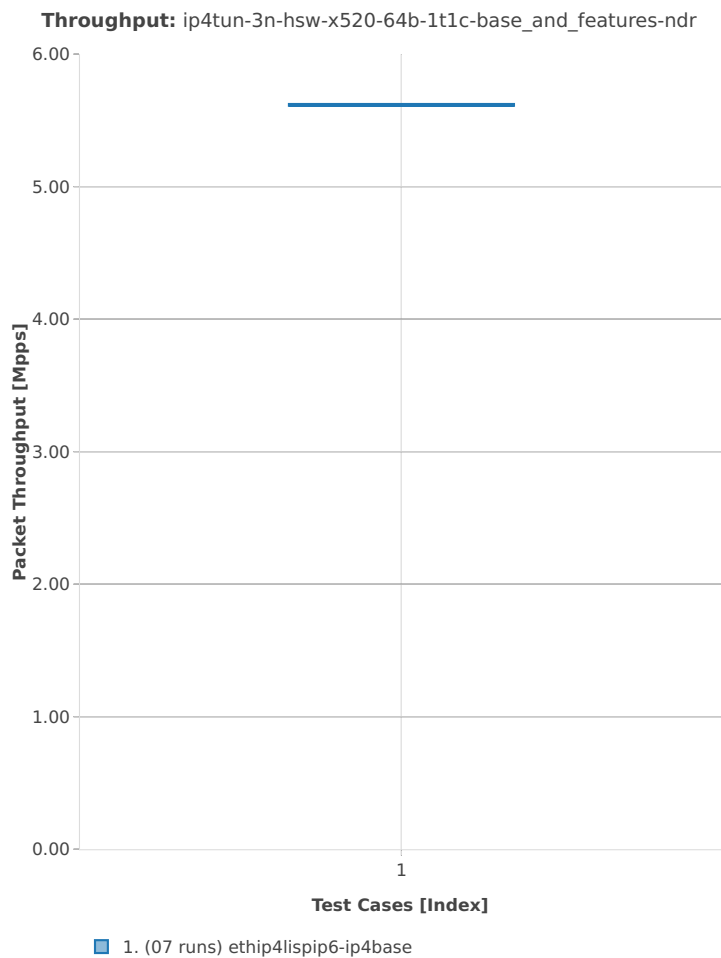

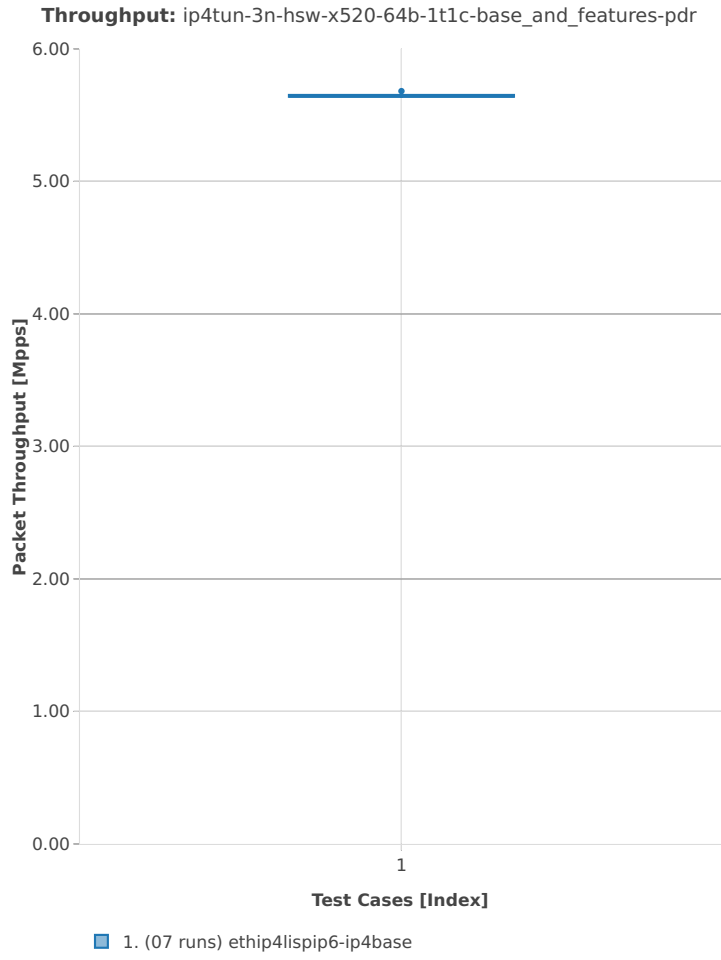

### 64b-2t2c-base\_and\_features

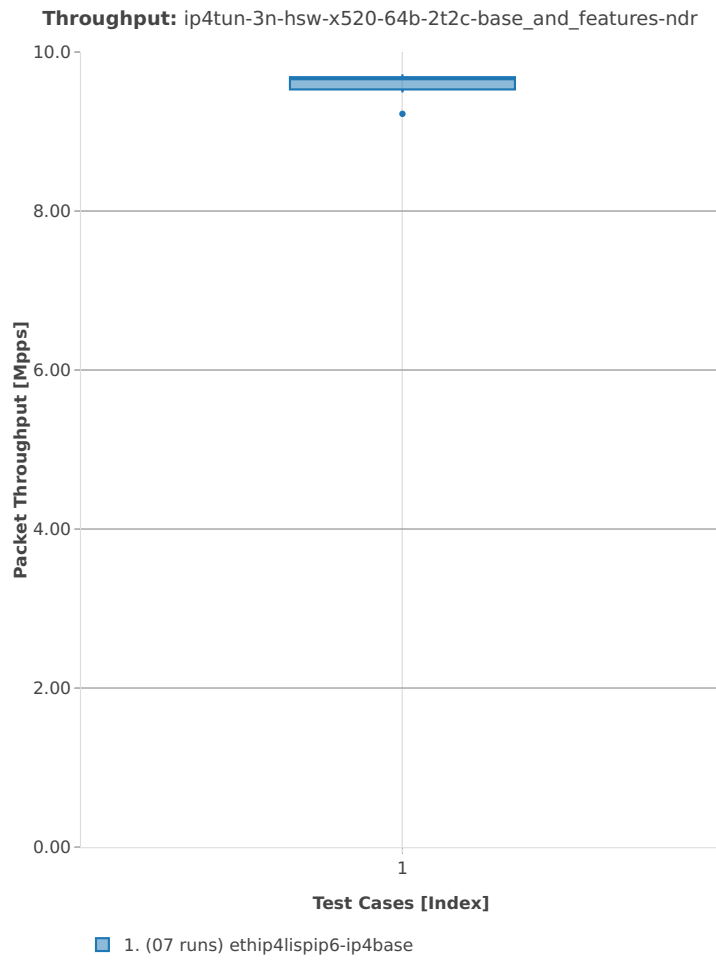

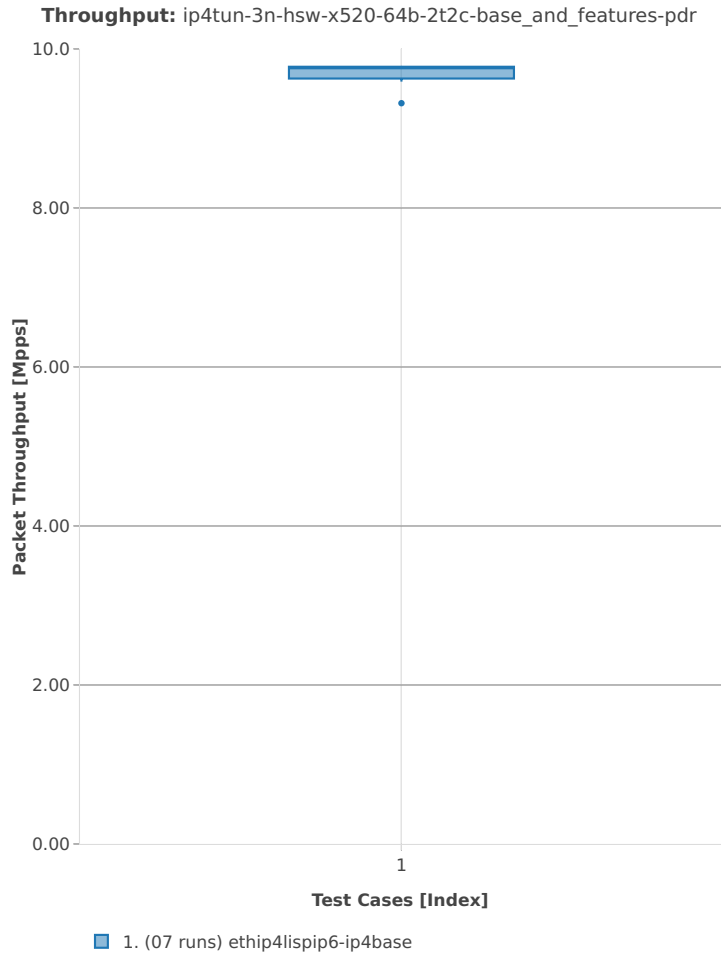

3n-hsw-x710

64b-1t1c-base\_and\_scale

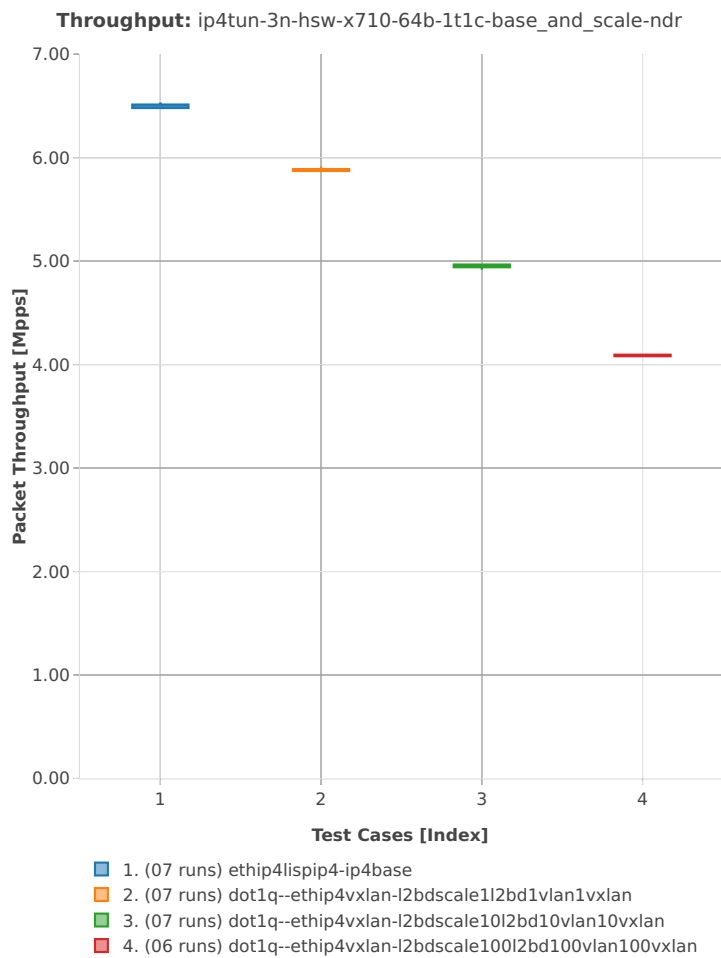

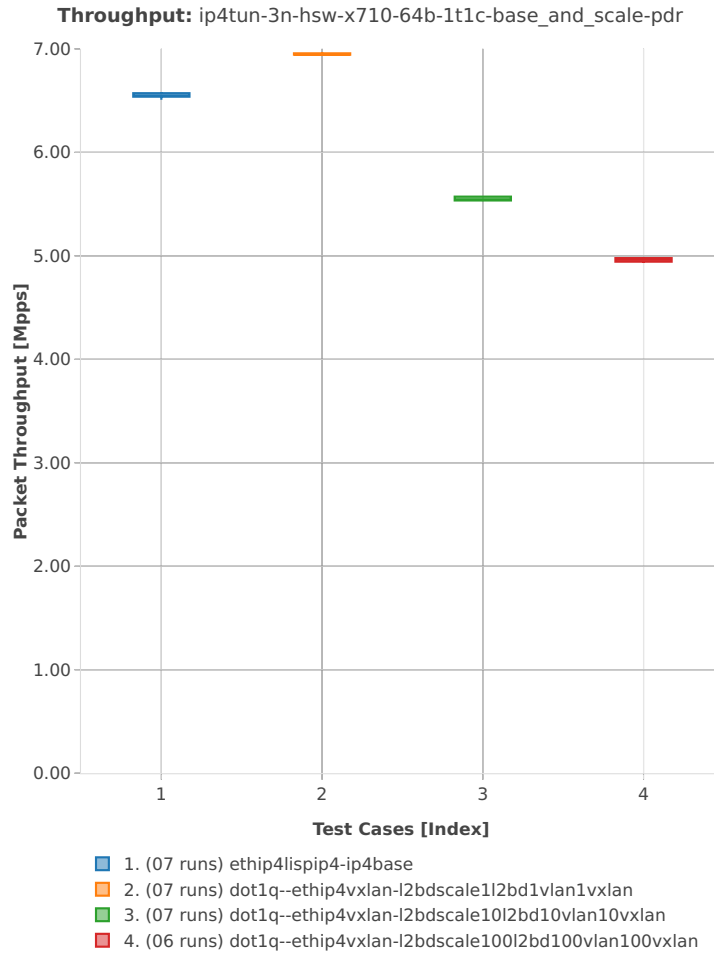

64b-2t2c-base\_and\_scale

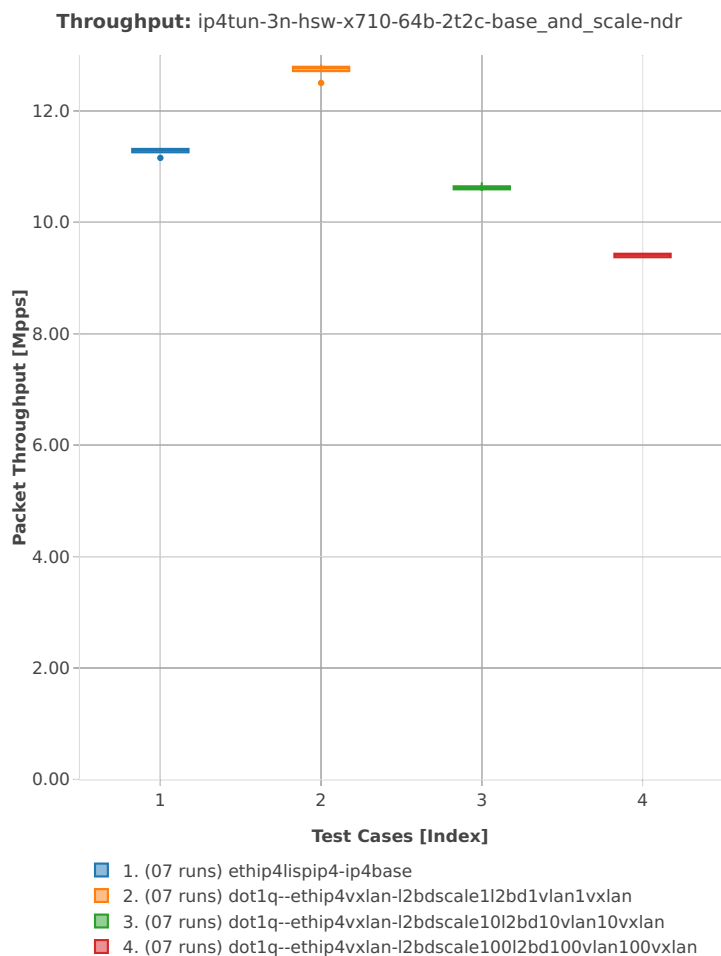

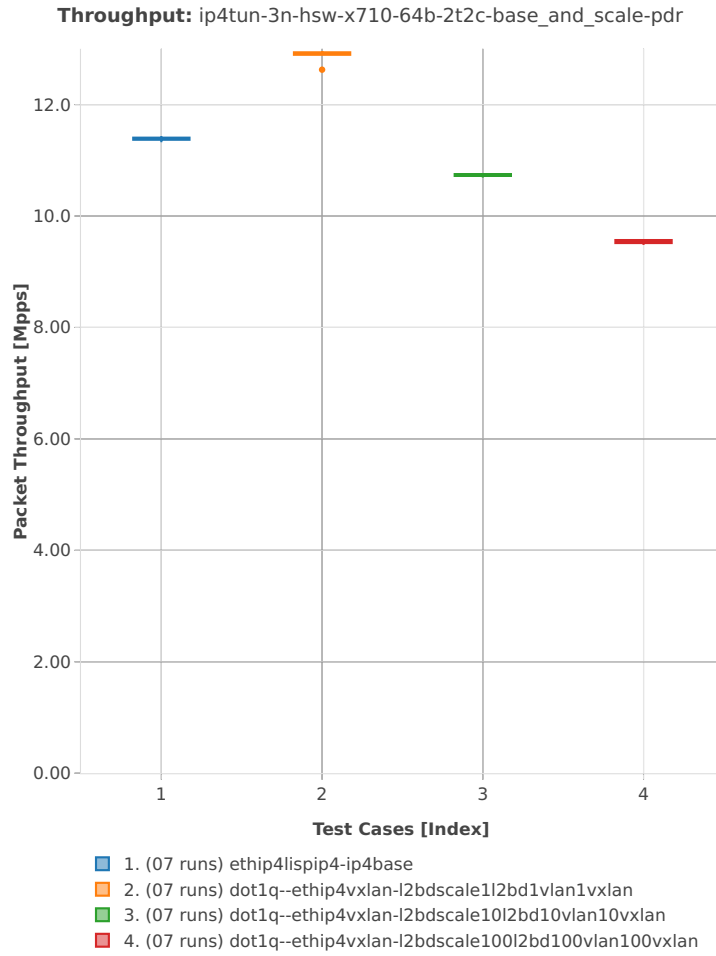



64b-1t1c-base\_and\_features

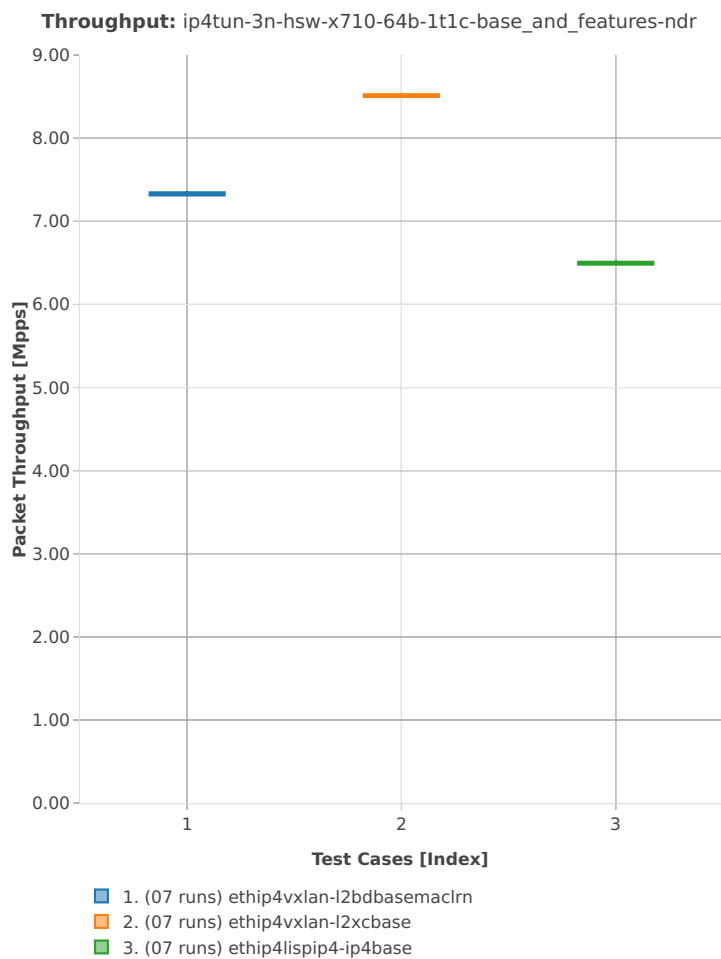

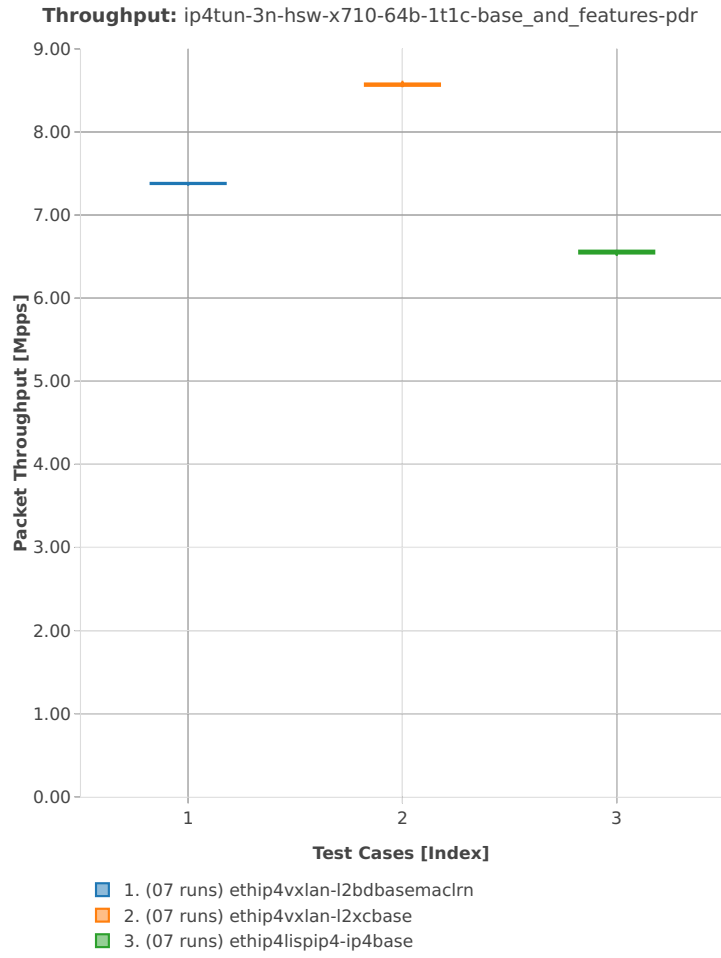

64b-2t2c-base\_and\_features

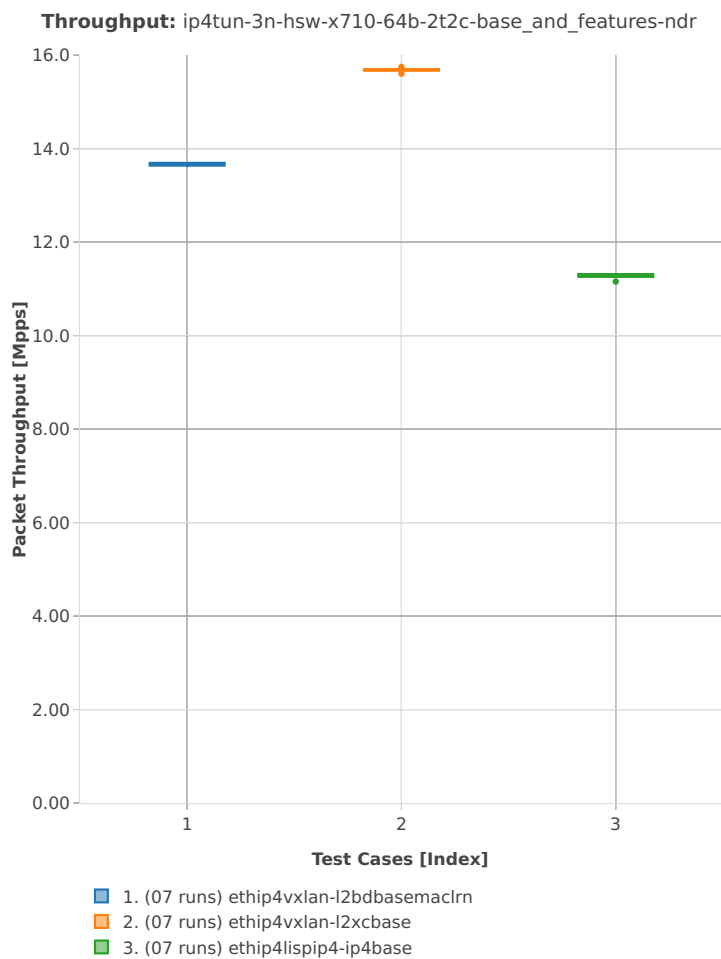

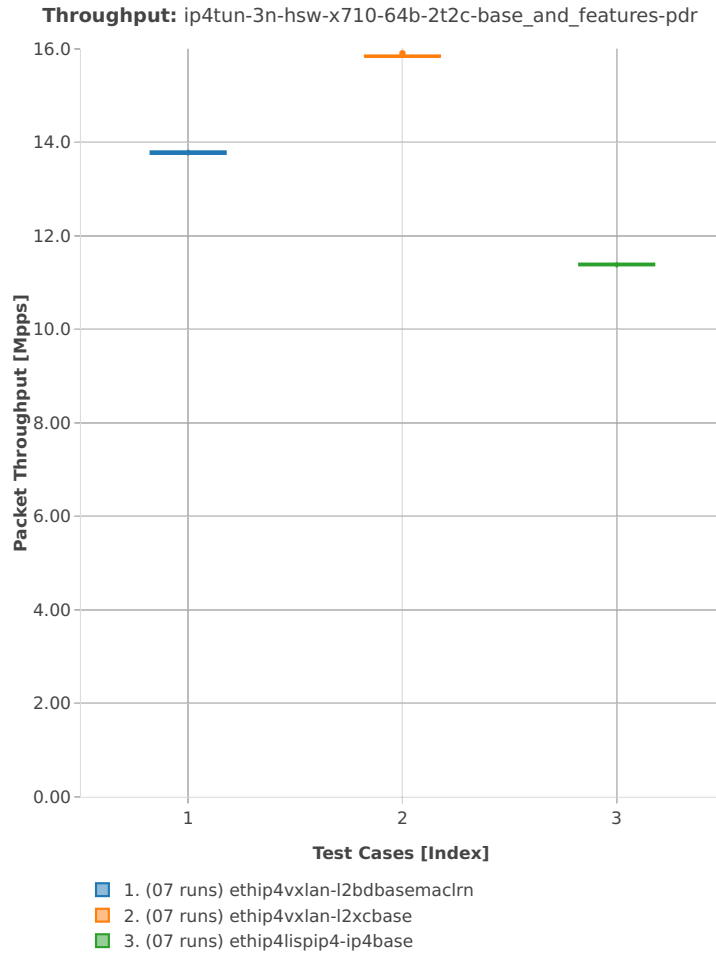

3n-skx-x710

64b-2t1c-base\_and\_scale

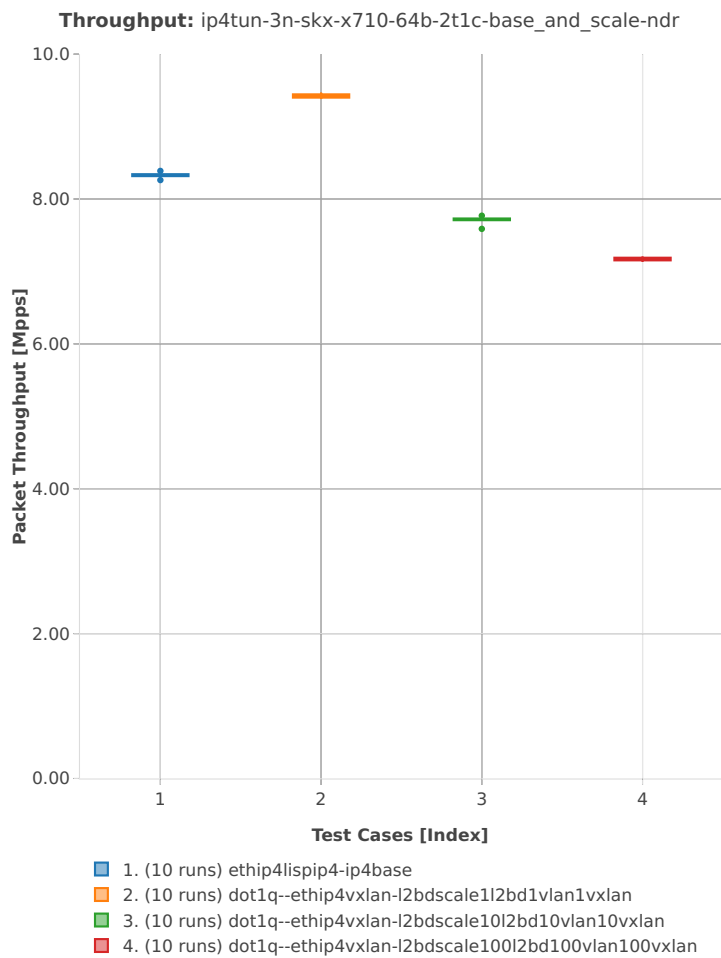

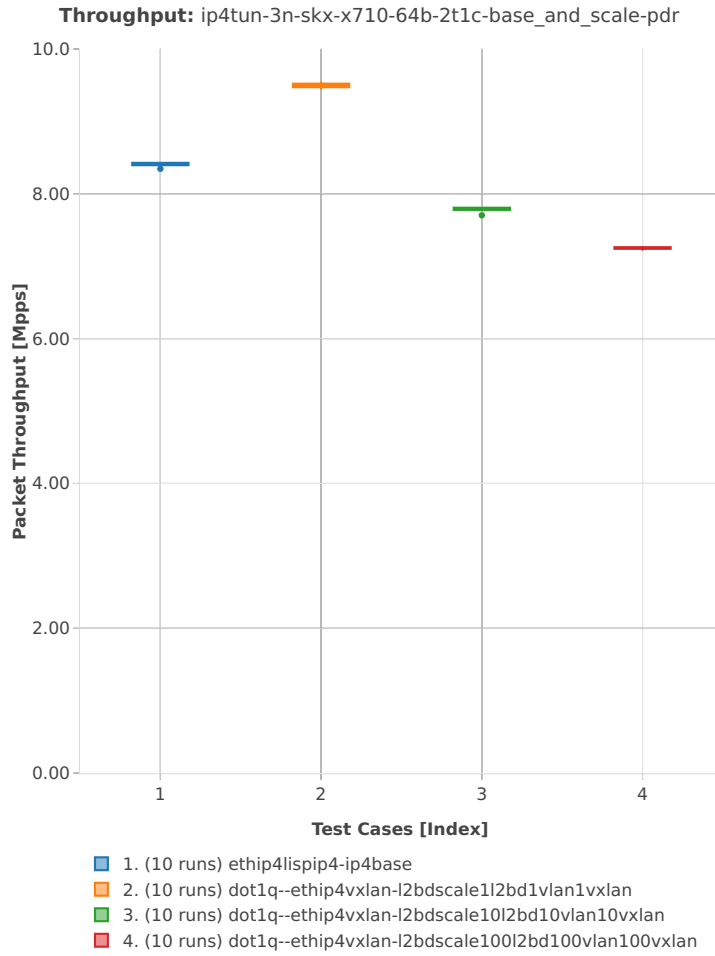

### 64b-4t2c-base\_and\_scale

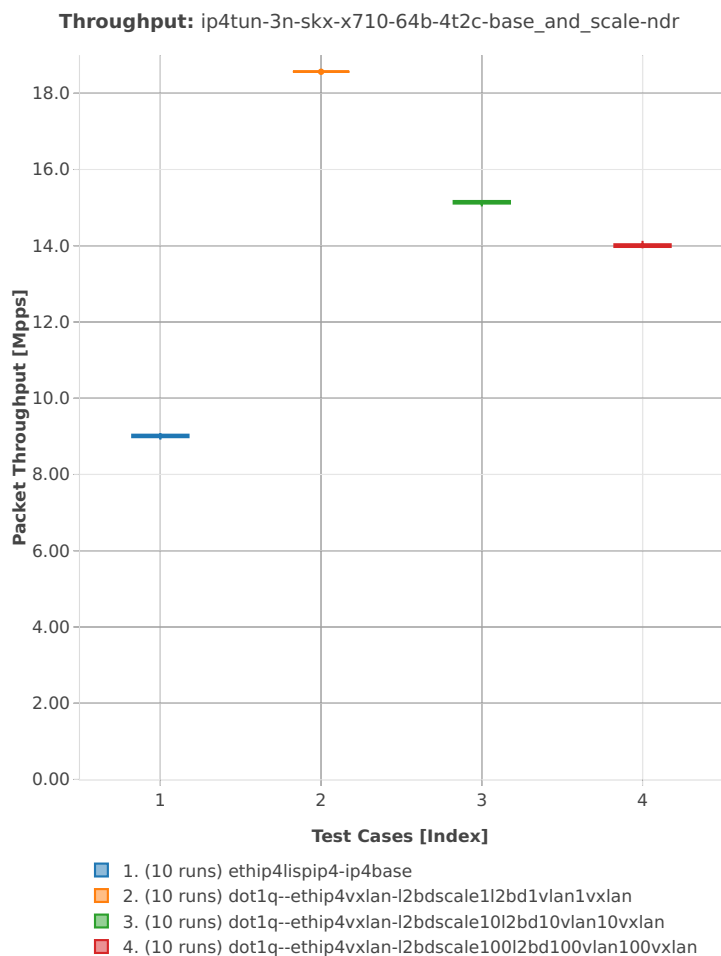

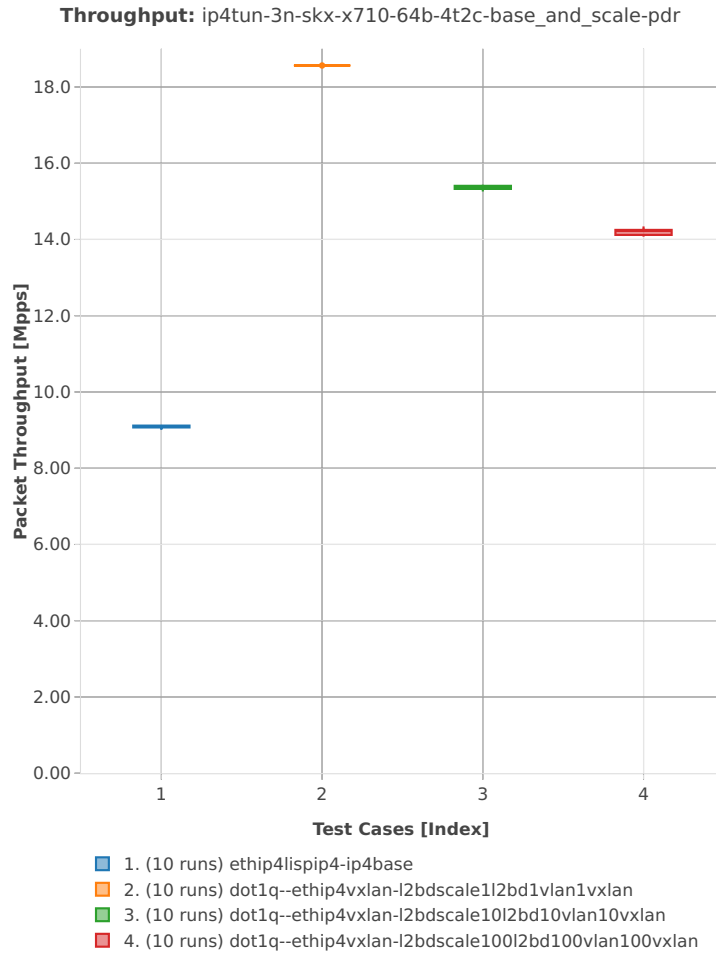



64b-2t1c-base\_and\_features

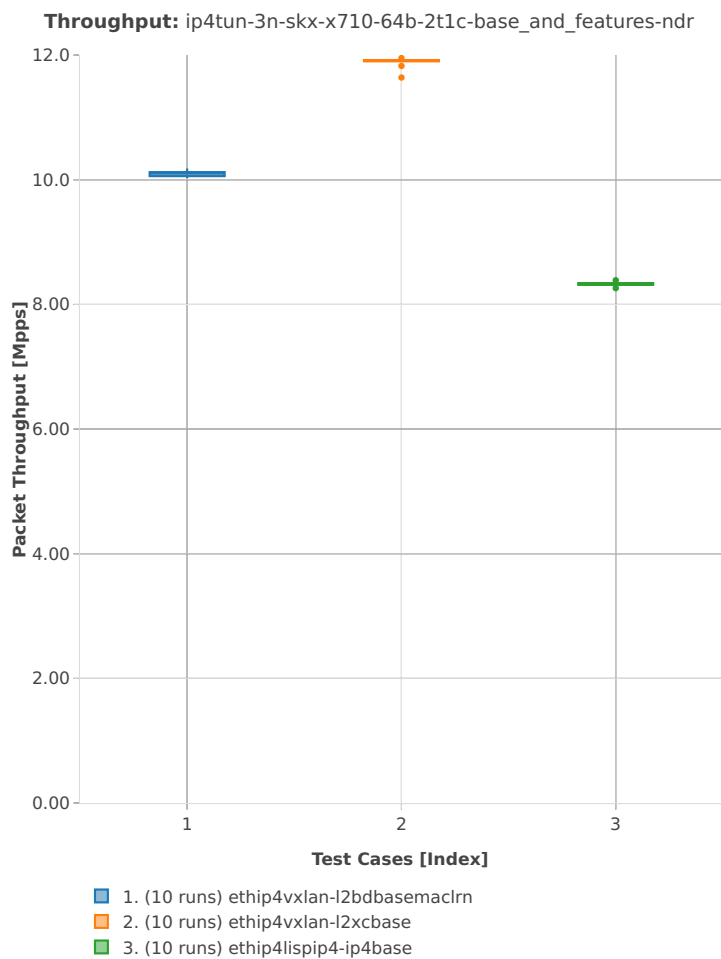

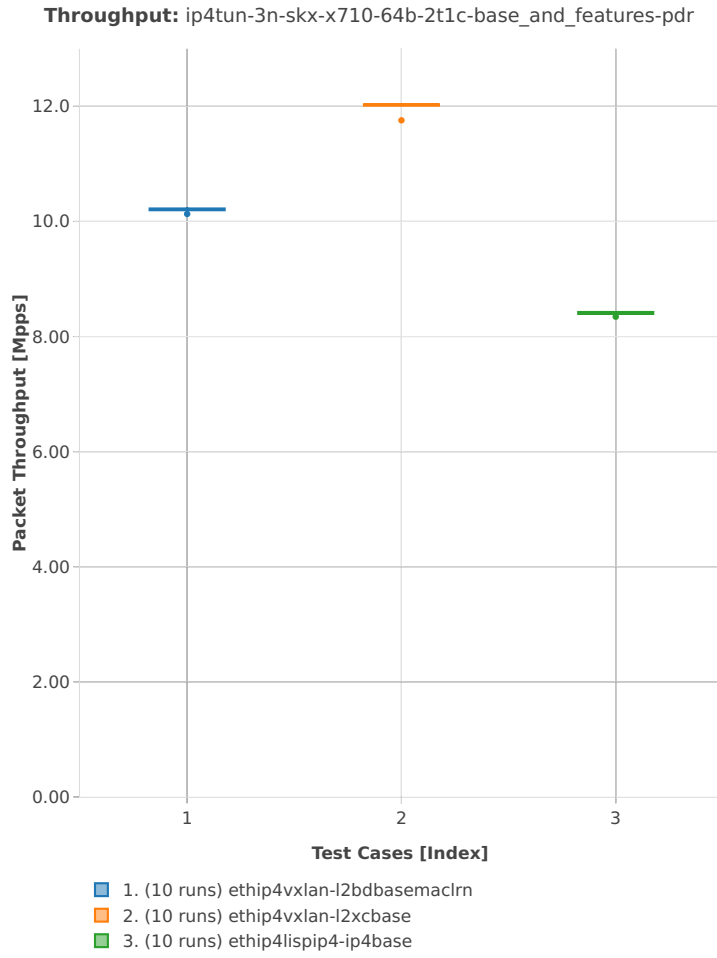

64b-4t2c-base\_and\_features

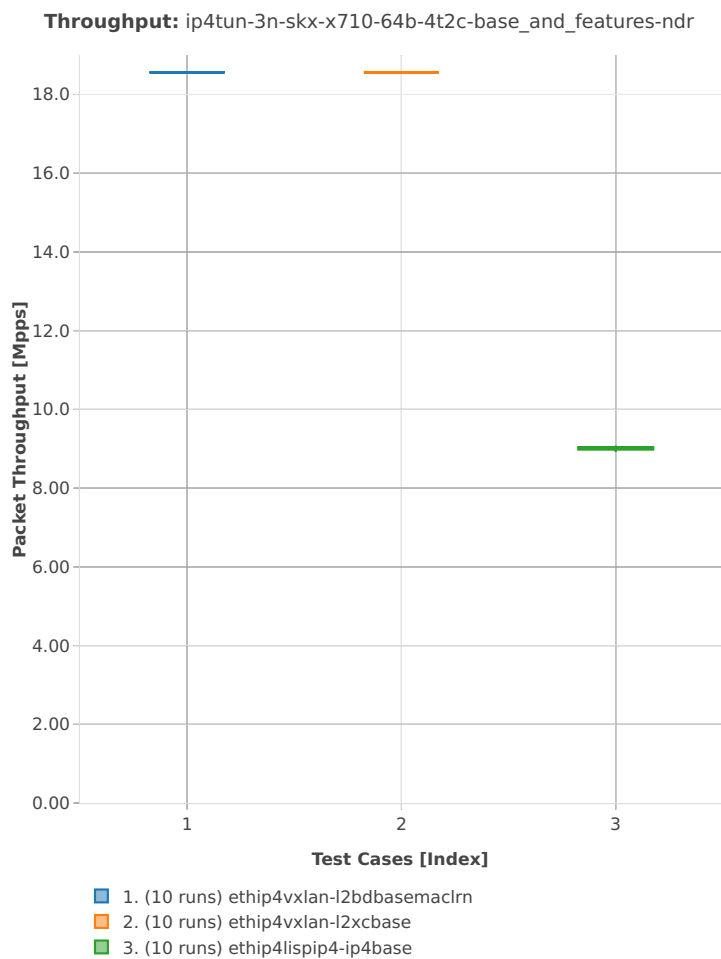

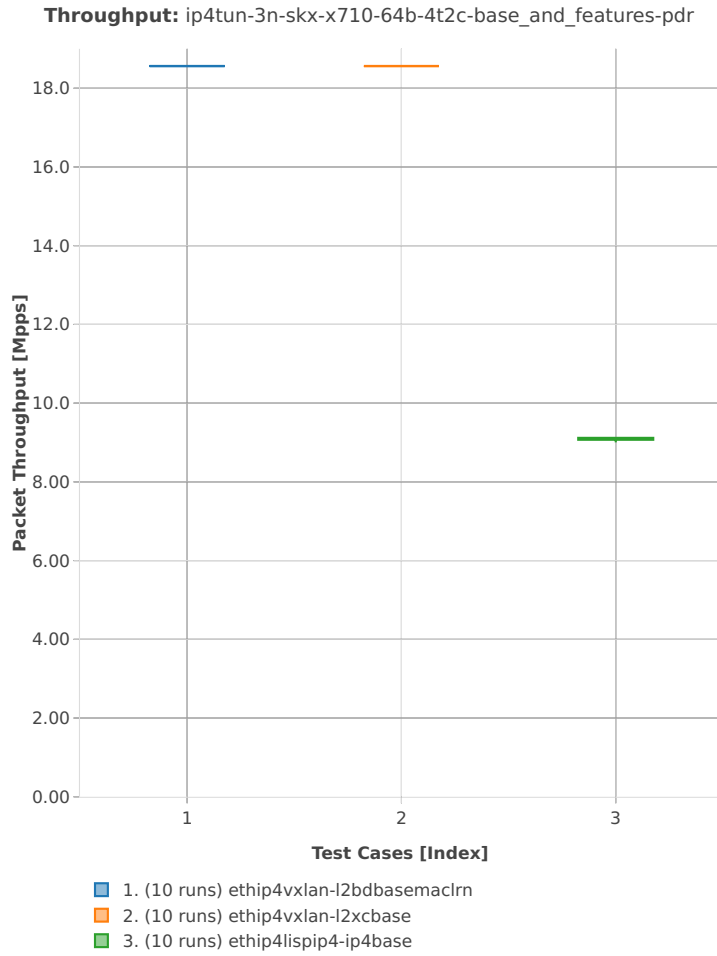

### 2.3.6 IPv6 Tunnels

Following sections include summary graphs of VPP Phy-to-Phy performance with IPv6 Overlay Tunnels, including NDR throughput (zero packet loss) and PDR throughput (<0.5% packet loss). Performance is reported for VPP running in multiple configurations of VPP worker thread(s), a.k.a. VPP data plane thread(s), and their physical CPU core(s) placement.

CSIT source code for the test cases used for plots can be found in [CSIT git repository](#)<sup>47</sup>.

---

<sup>47</sup> [https://git.fd.io/csit/tree/tests/vpp/perf/ip6\\_tunnels?h=rls1901](https://git.fd.io/csit/tree/tests/vpp/perf/ip6_tunnels?h=rls1901)

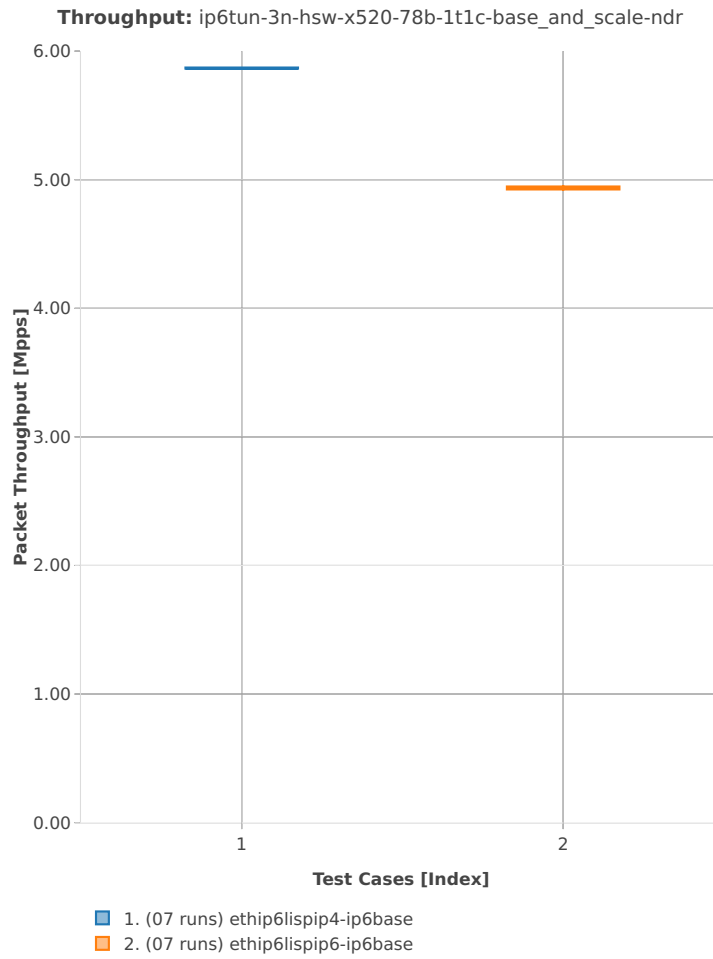
**3n-hsw-x520****78b-1t1c-base\_and\_scale**

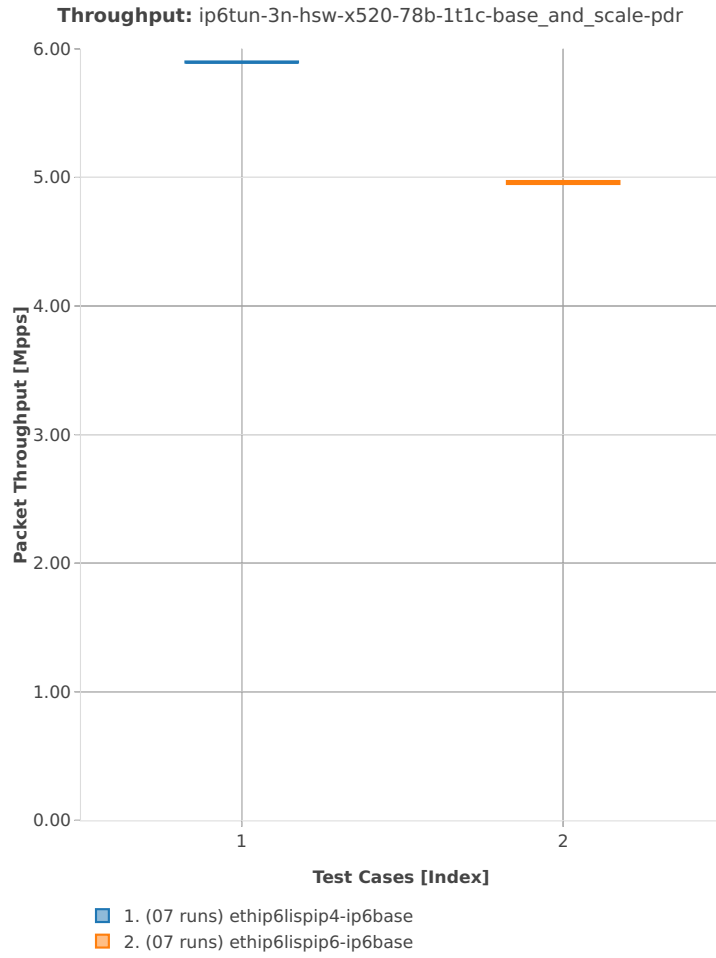

## 78b-2t2c-base\_and\_scale

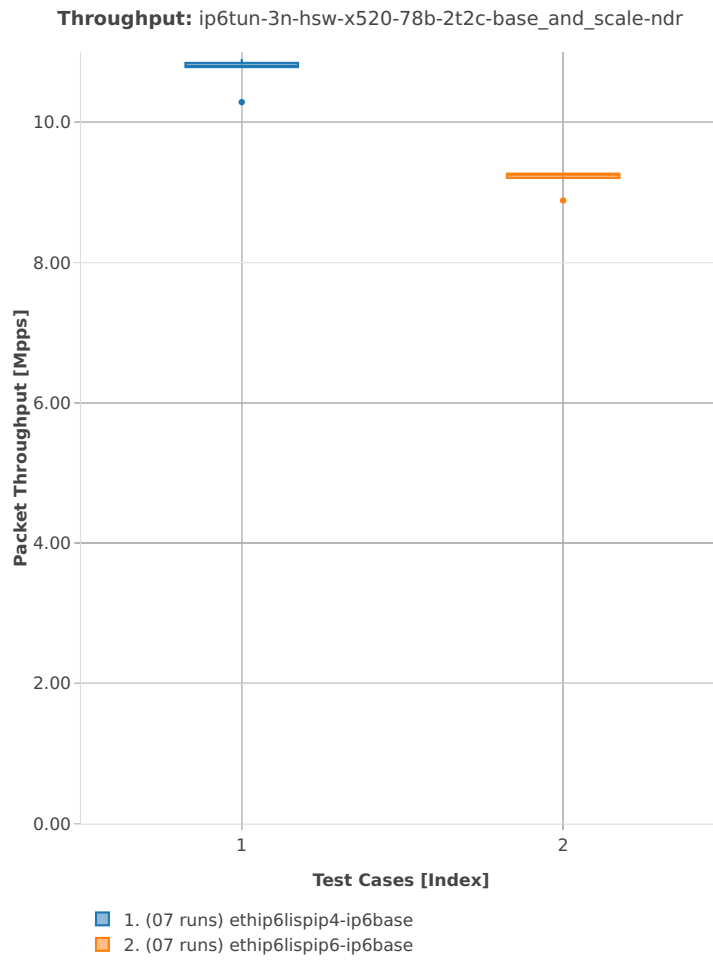



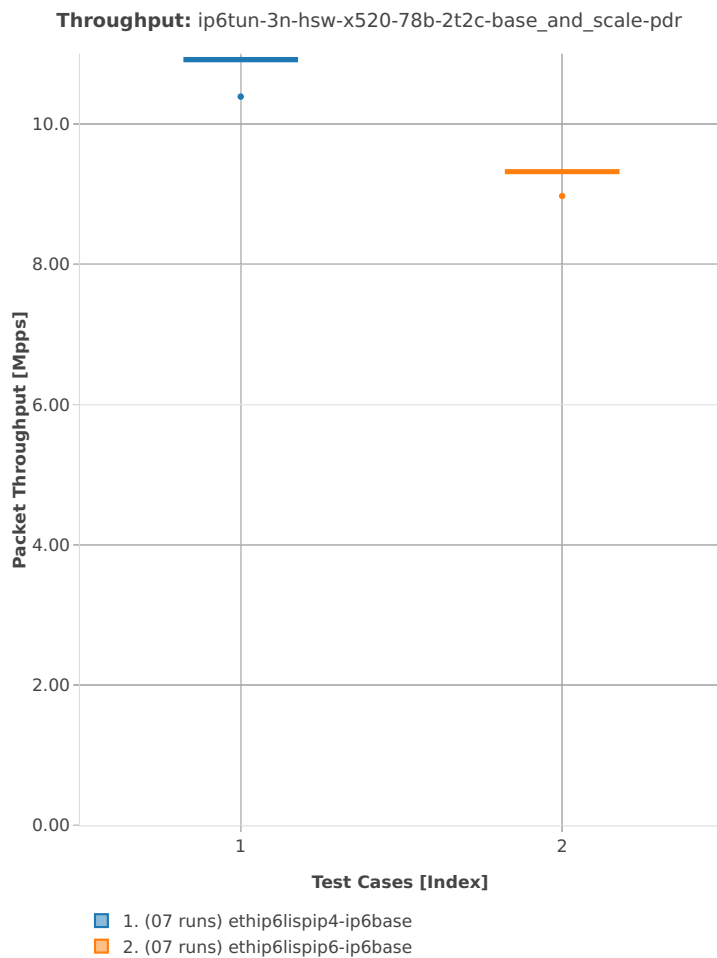

### 2.3.7 KVM VMs vhost-user

Following sections include summary graphs of VPP Phy-to-VM(s)-to-Phy performance with VM virtio and VPP vhost-user virtual interfaces, including NDR throughput (zero packet loss) and PDR throughput (<0.5% packet loss). Performance is reported for VPP running in multiple configurations of VPP worker thread(s), a.k.a. VPP data plane thread(s), and their physical CPU core(s) placement.

CSIT source code for the test cases used for plots can be found in [CSIT git repository](#)<sup>48</sup>.

---

<sup>48</sup> [https://git.fd.io/csit/tree/tests/vpp/perf/vm\\_vhost?h=rls1901](https://git.fd.io/csit/tree/tests/vpp/perf/vm_vhost?h=rls1901)

3n-hsw-x520

64b-1t1c-base-l2sw

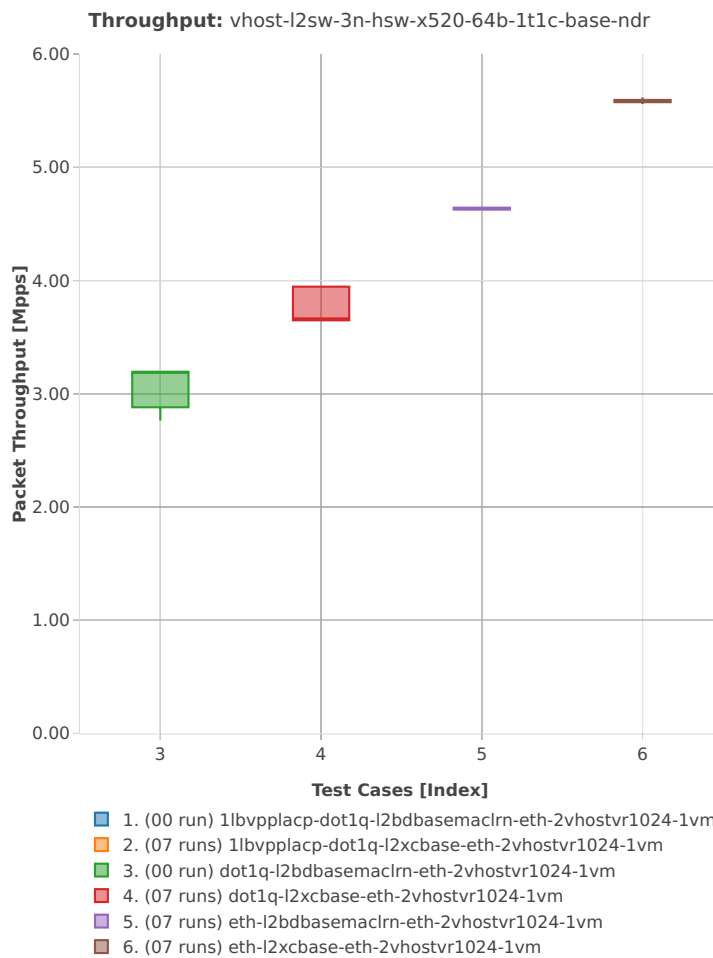

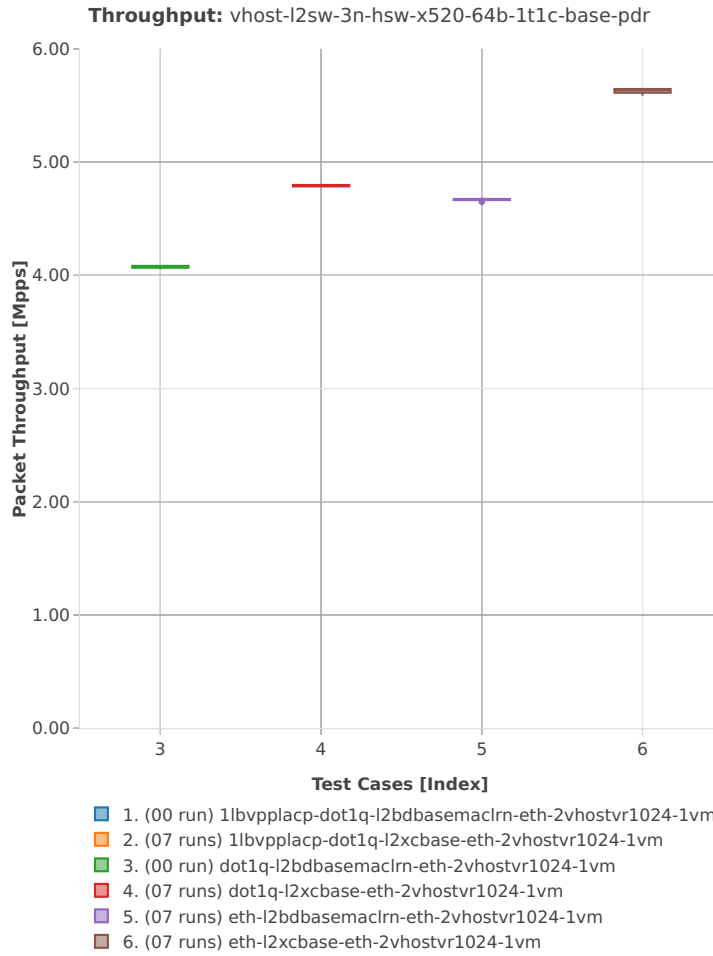

64b-2t2c-base-l2sw

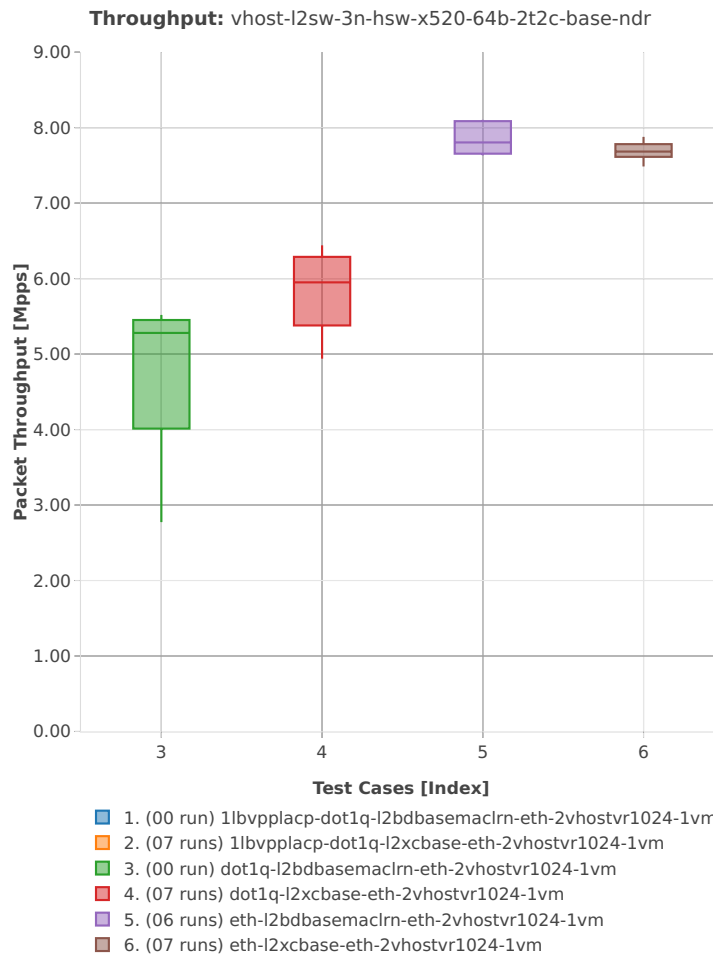

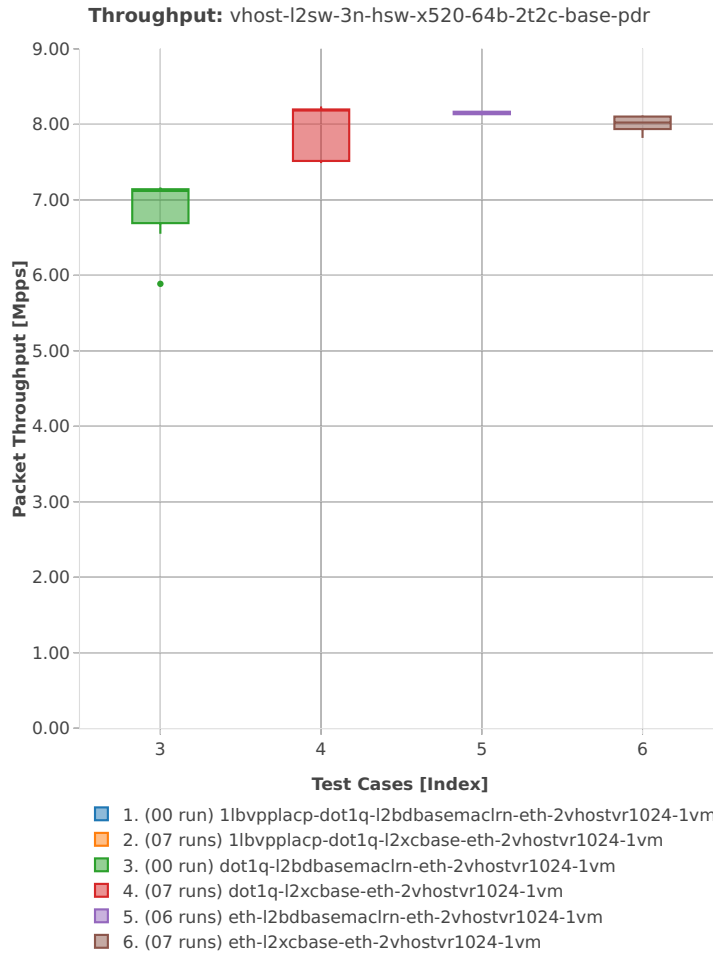

64b-1t1c-base\_and\_scale-l2sw

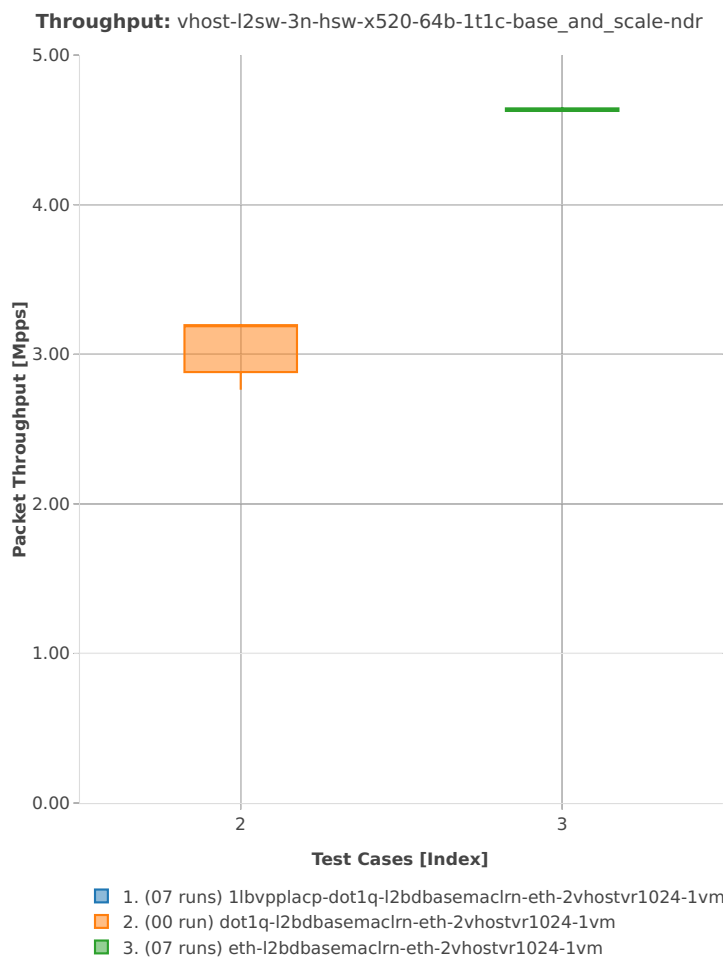

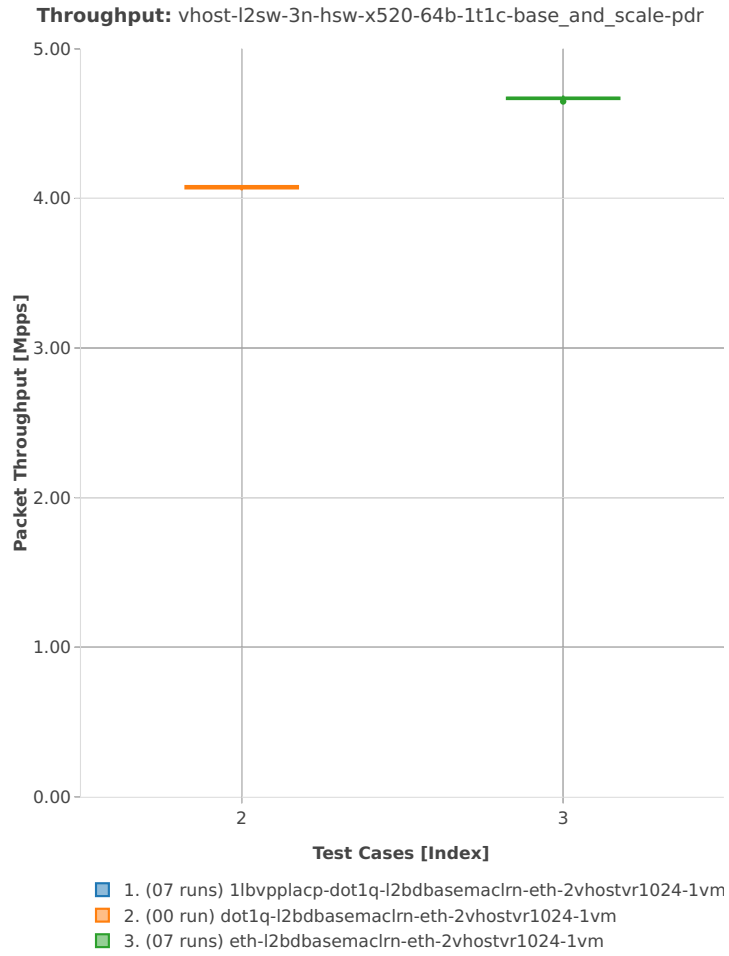



64b-2t2c-base\_and\_scale-l2sw

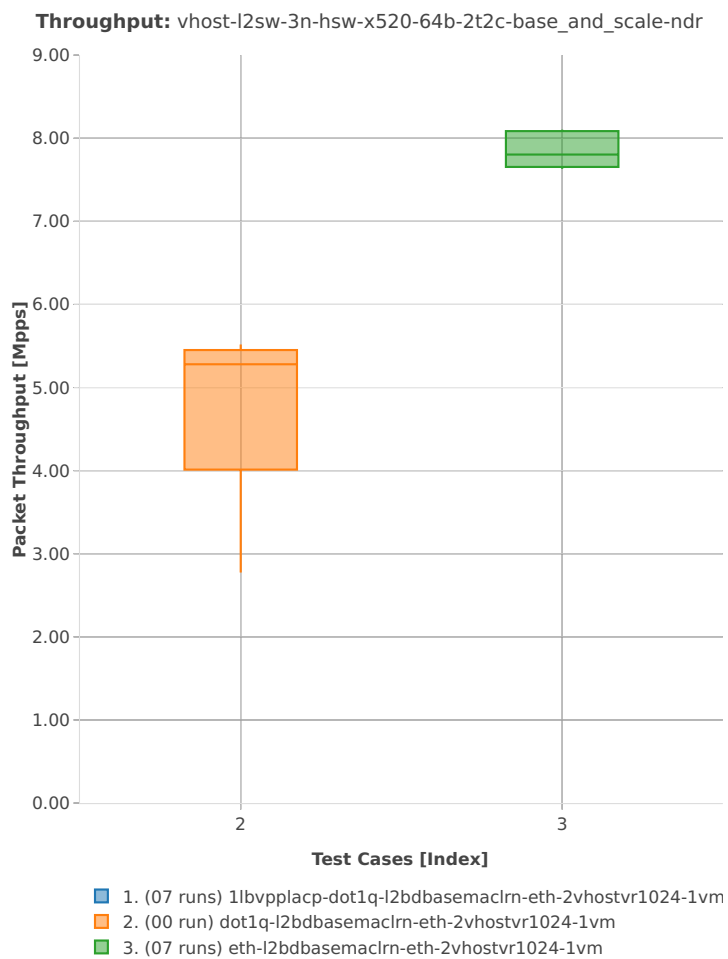

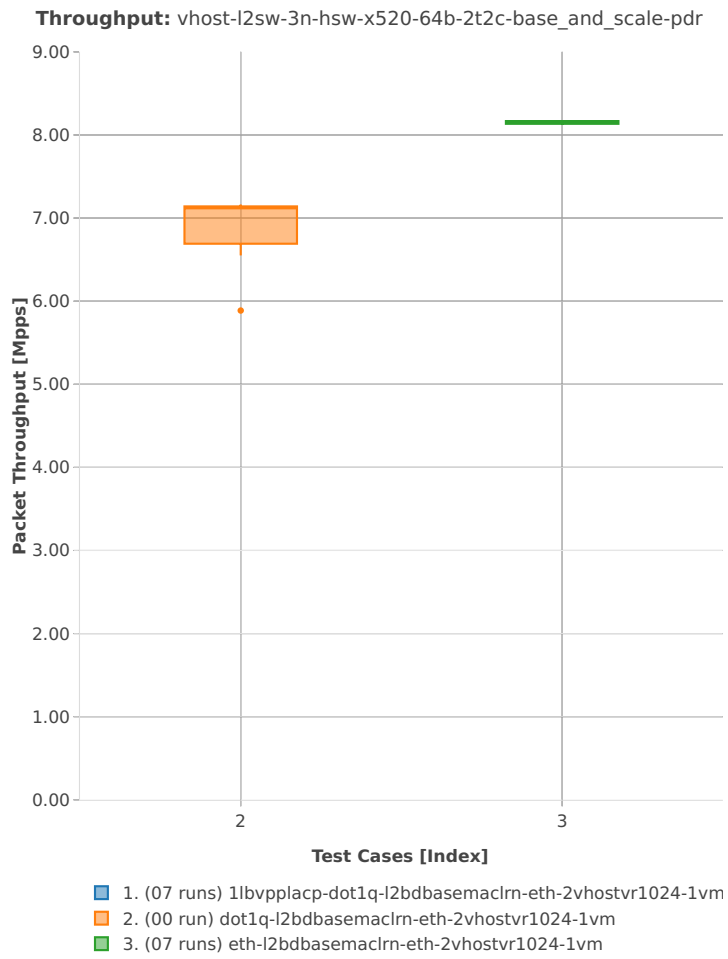

clearpage

64b-1t1c-base-vm-l2sw

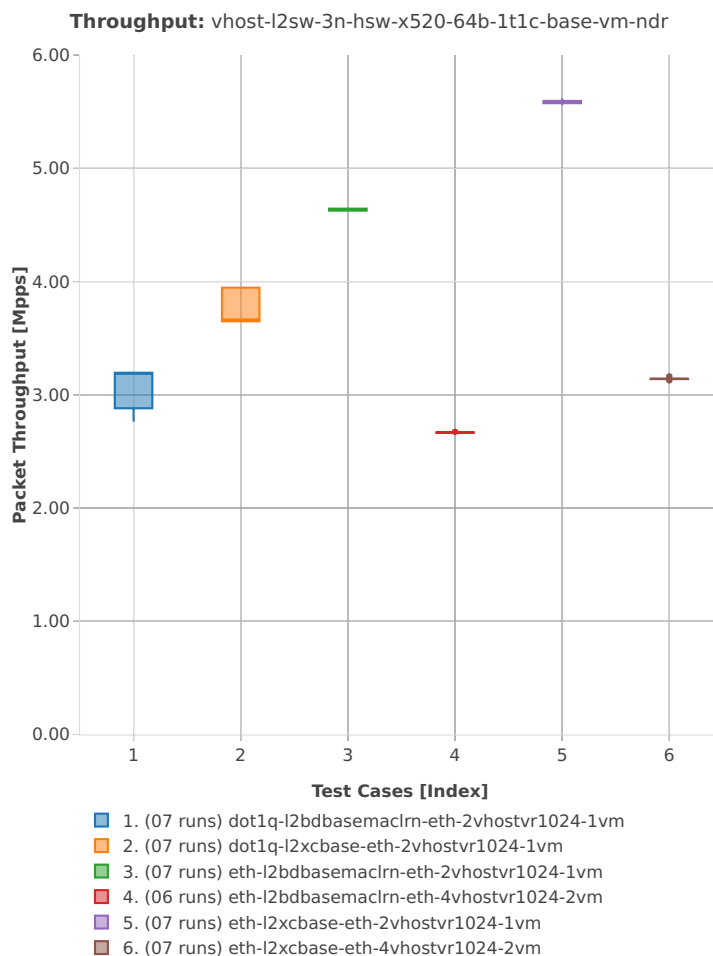

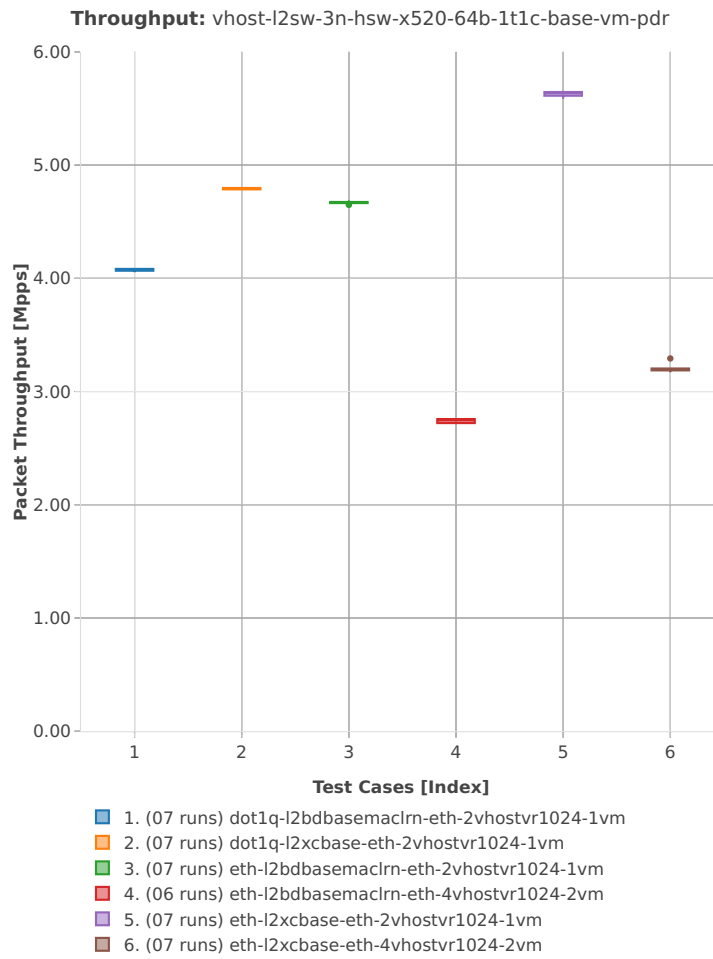

64b-2t2c-base-vm-l2sw

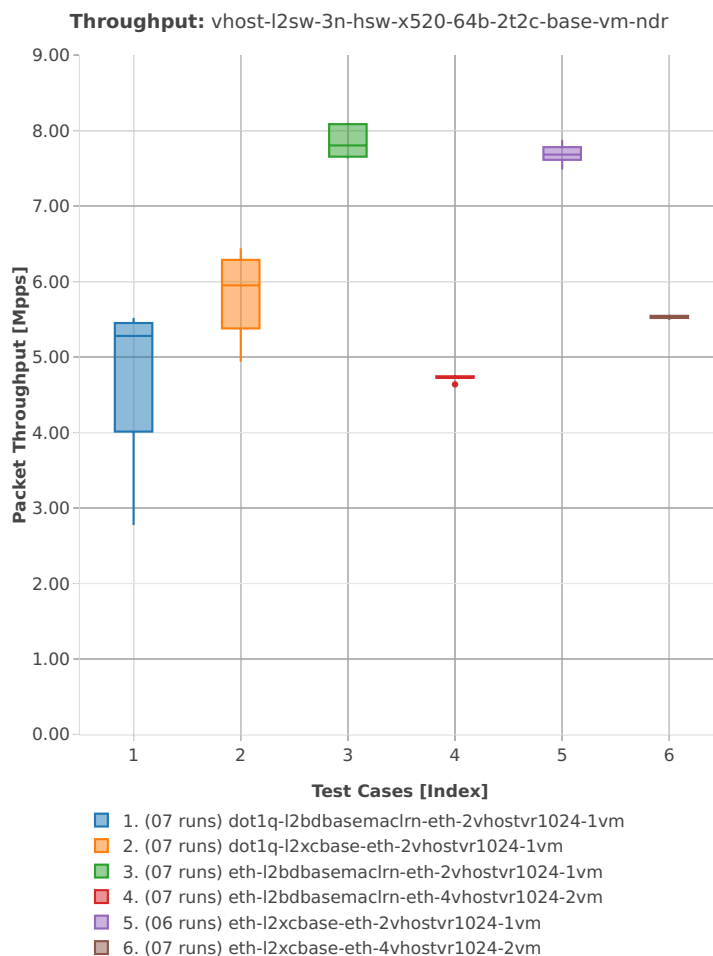

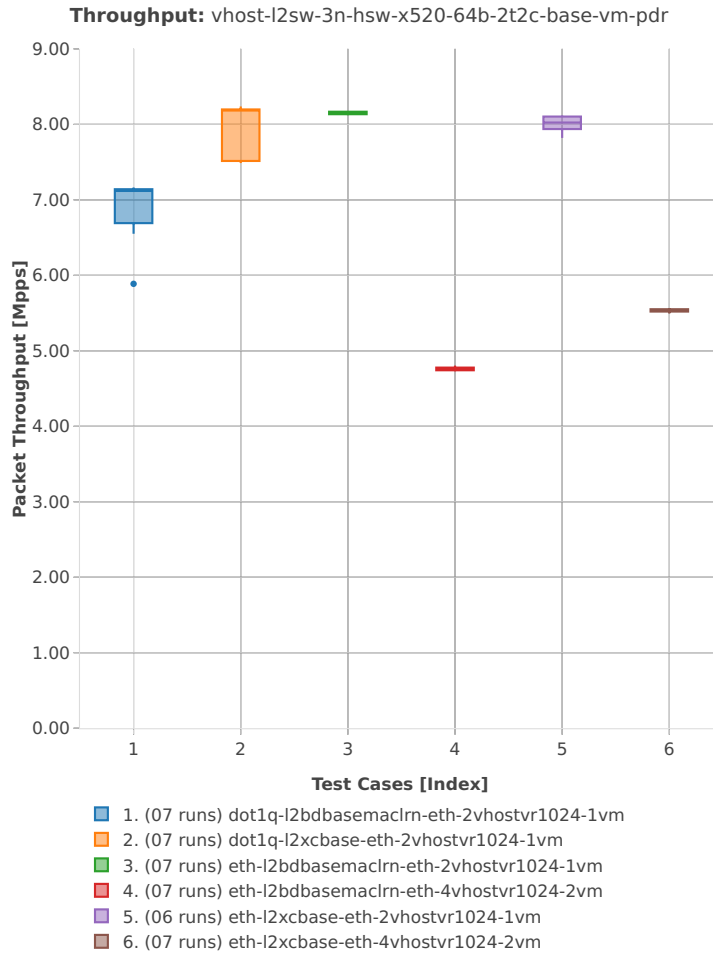

64b-1t1c-base\_and\_scale-ip4

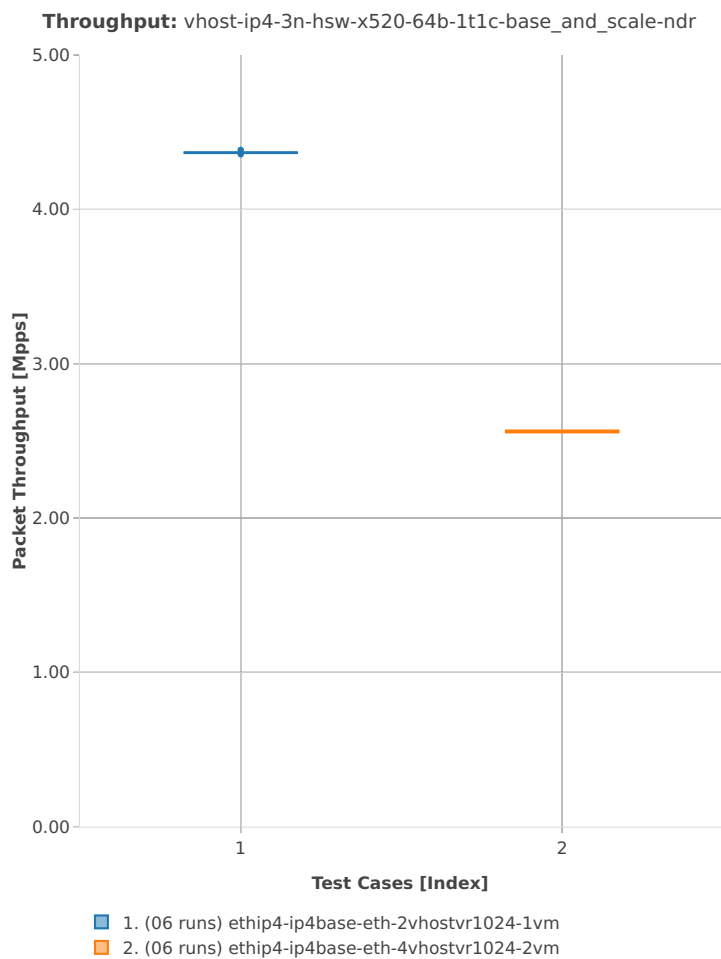

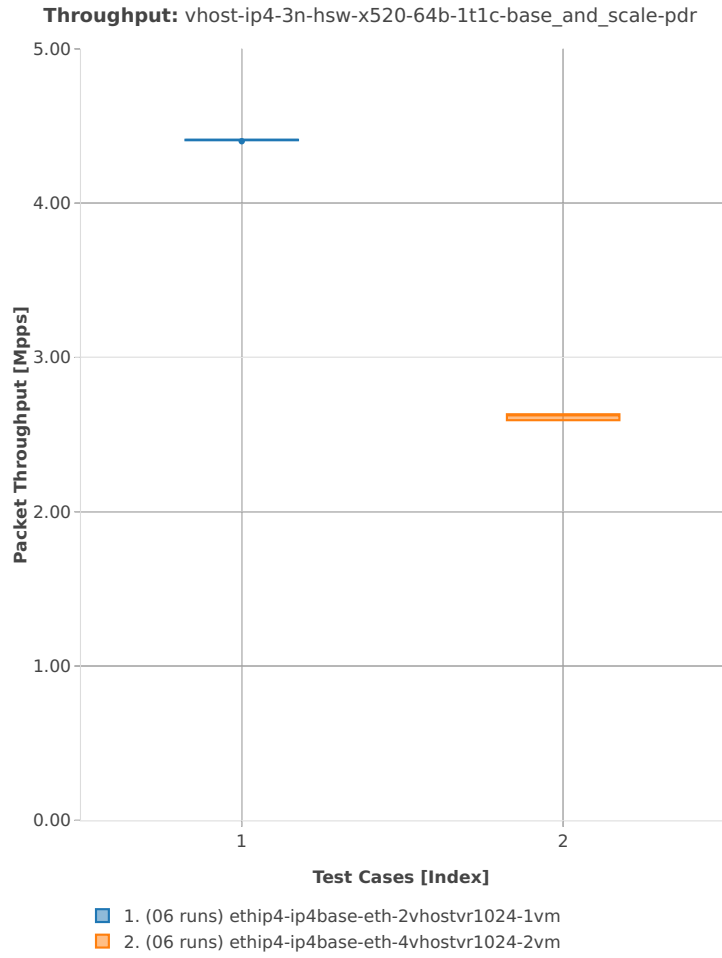



64b-2t2c-base\_and\_scale-ip4

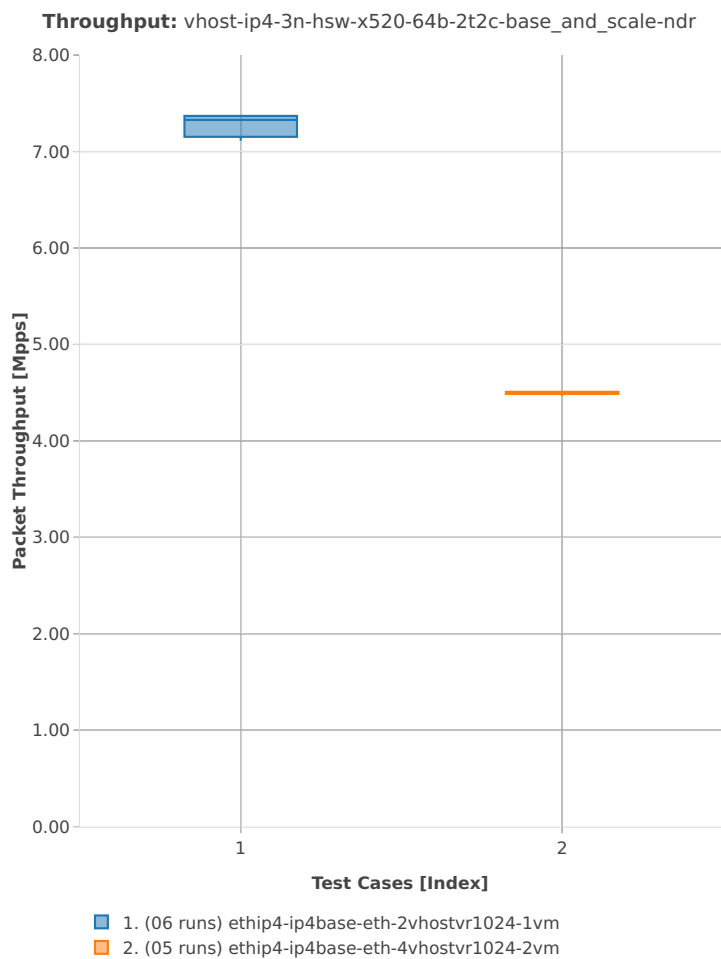

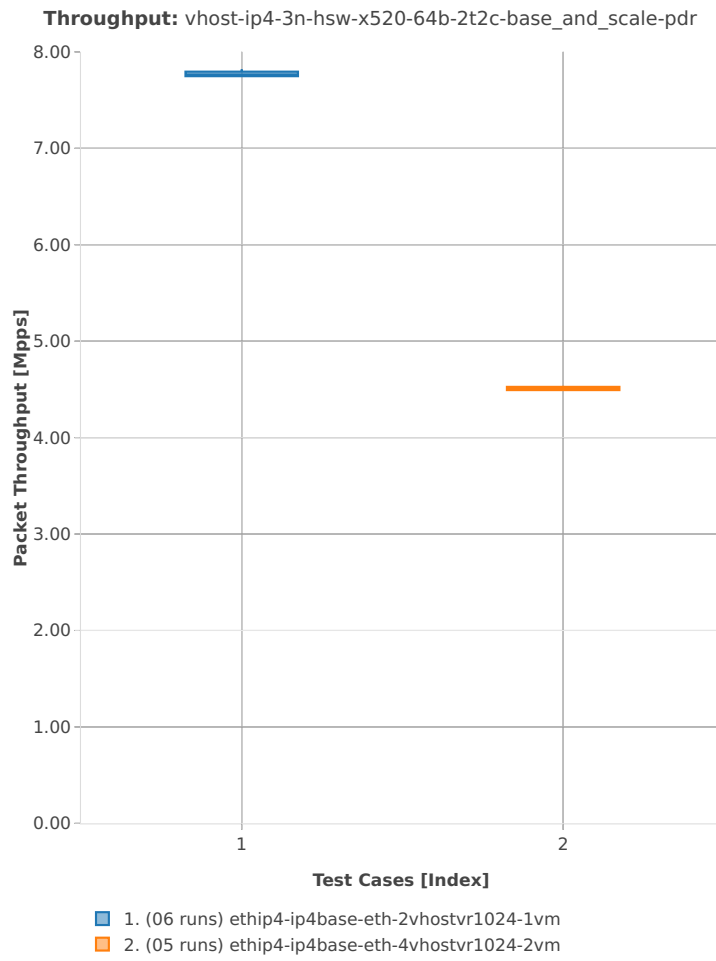

3n-hsw-x710

64b-1t1c-base-l2sw

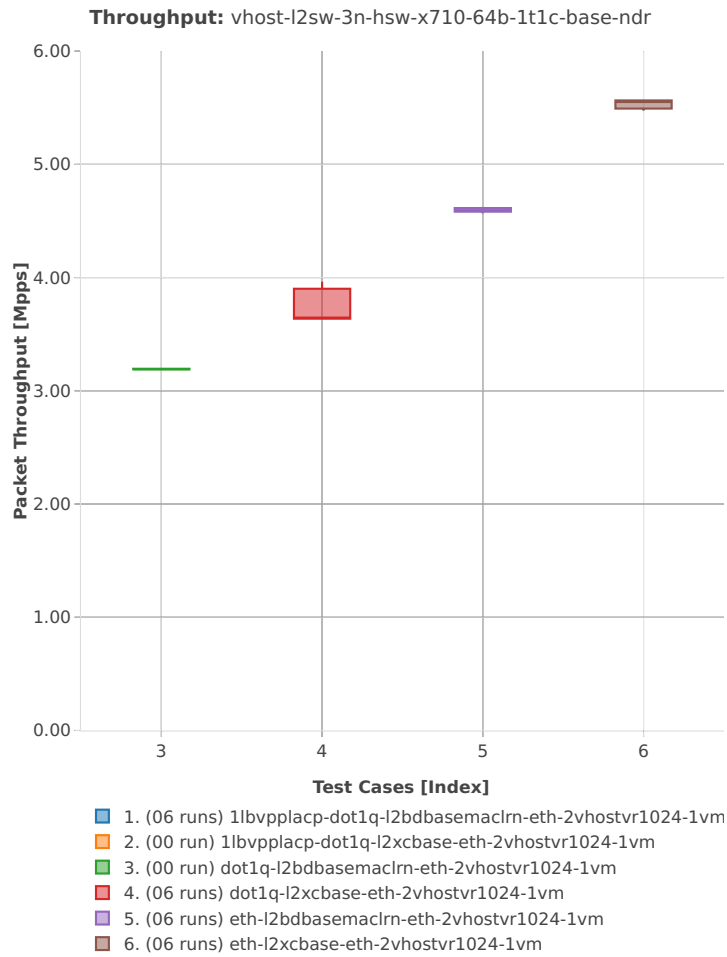

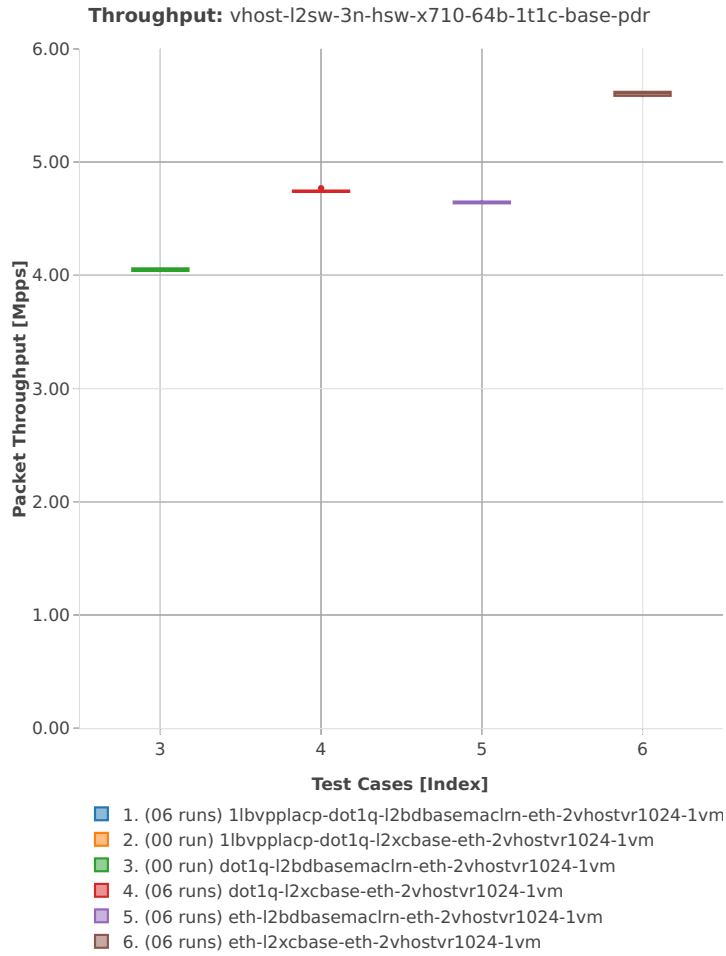

64b-2t2c-base-l2sw

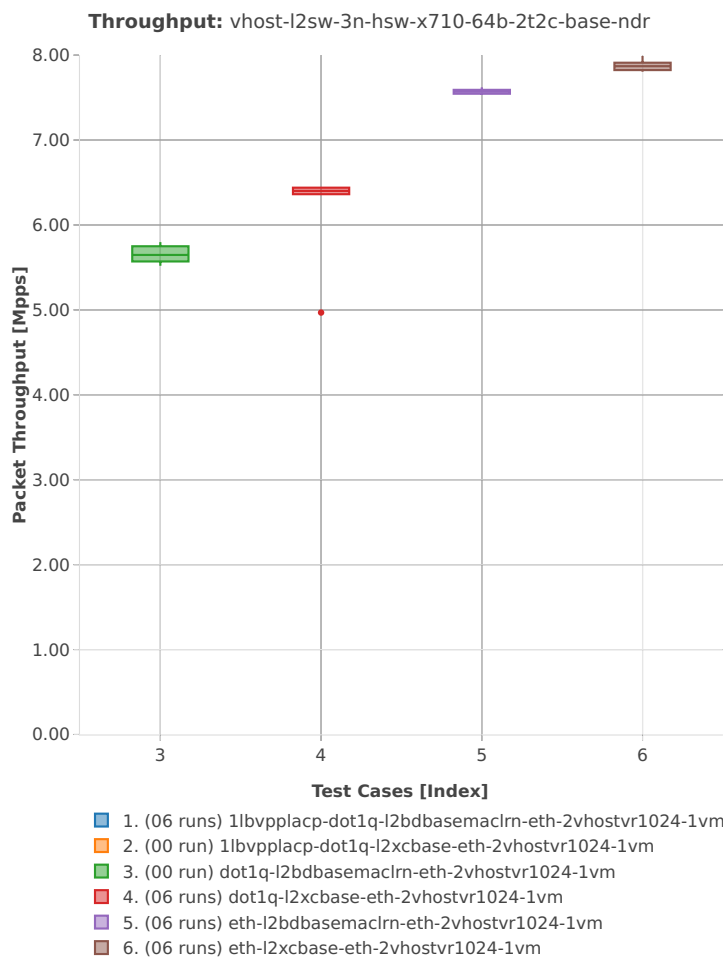

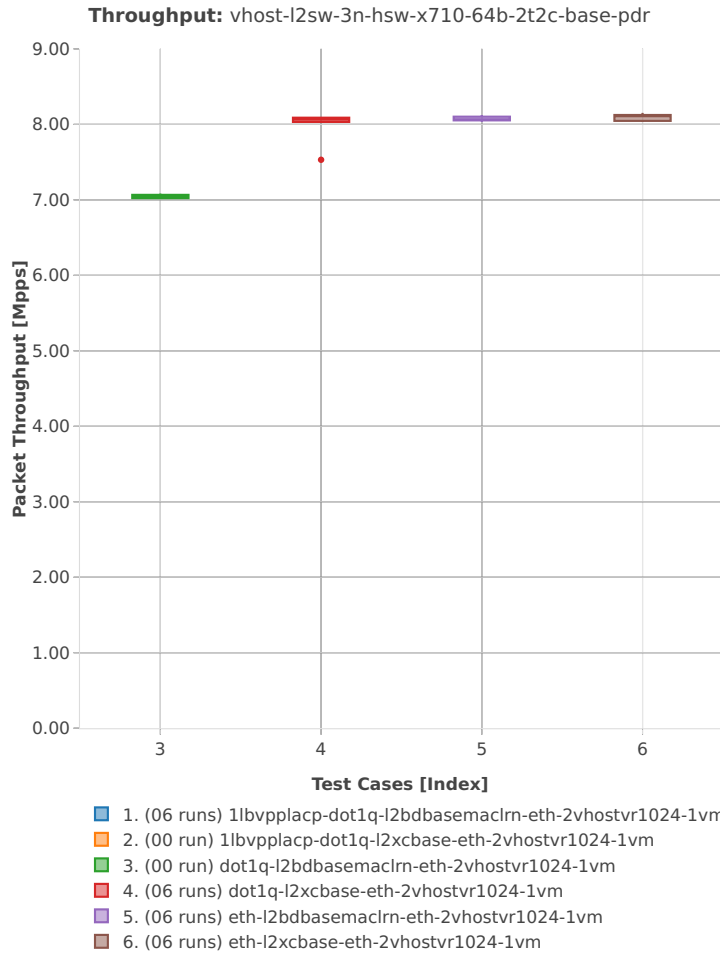

64b-1t1c-base\_and\_scale-l2sw

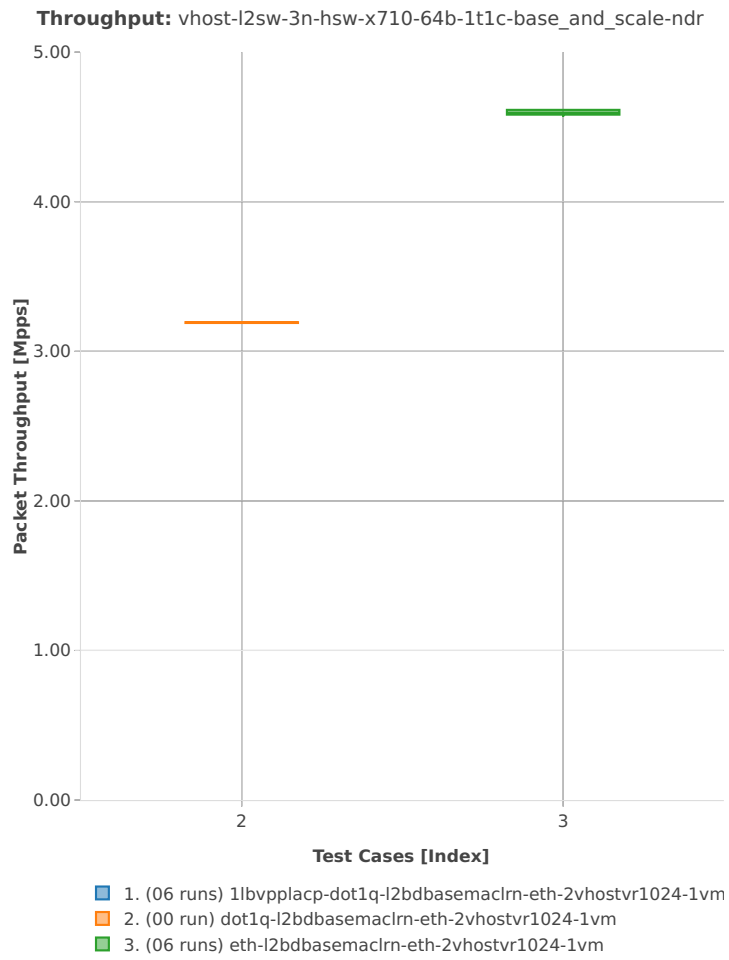

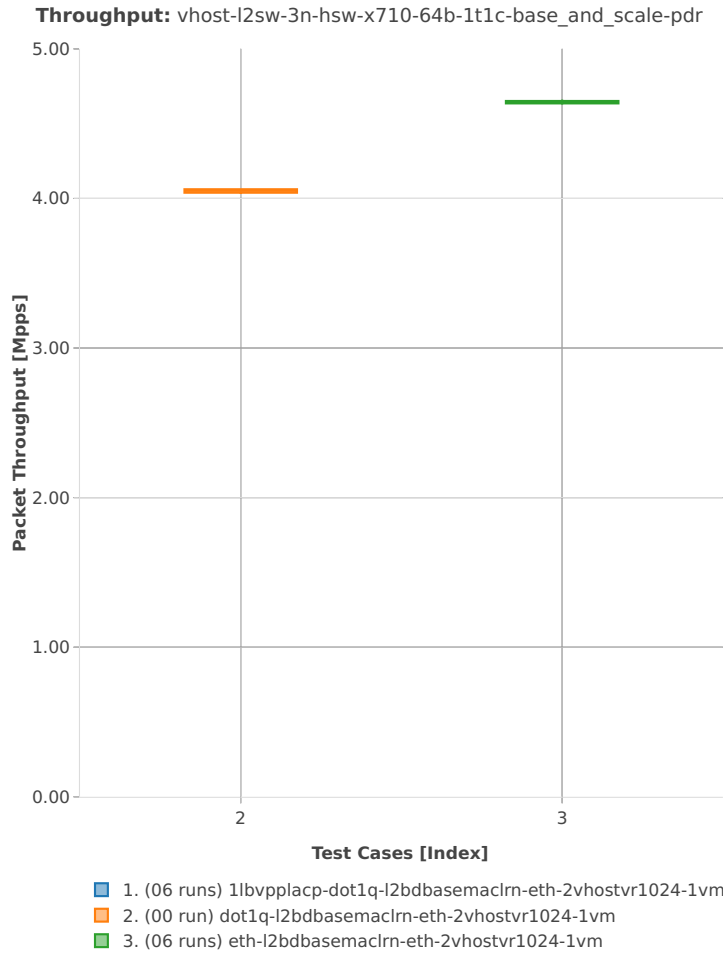



64b-2t2c-base\_and\_scale-l2sw

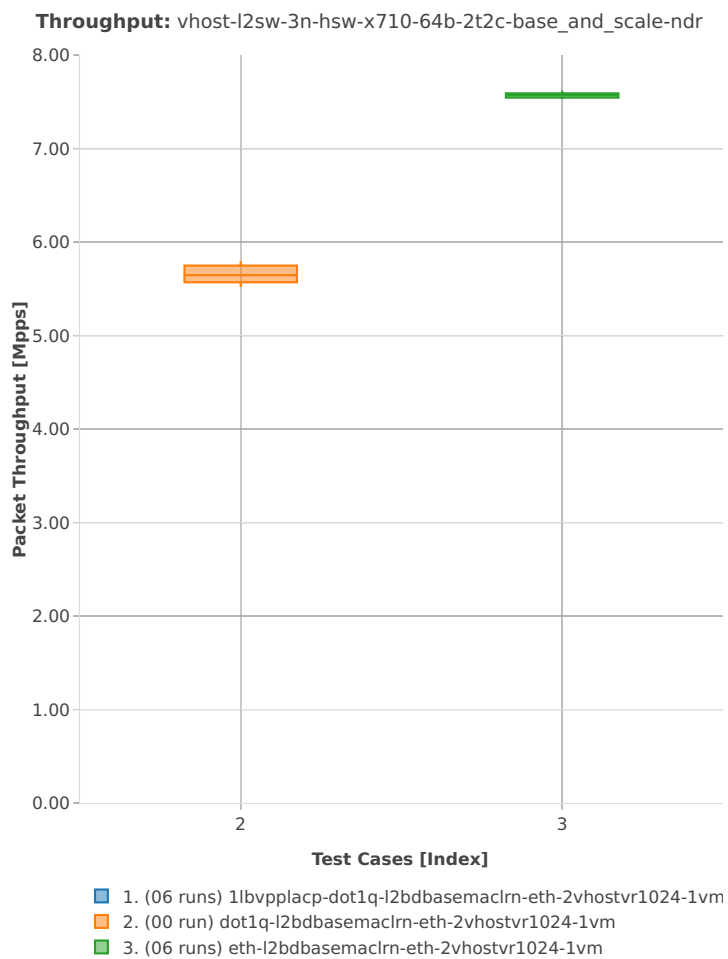

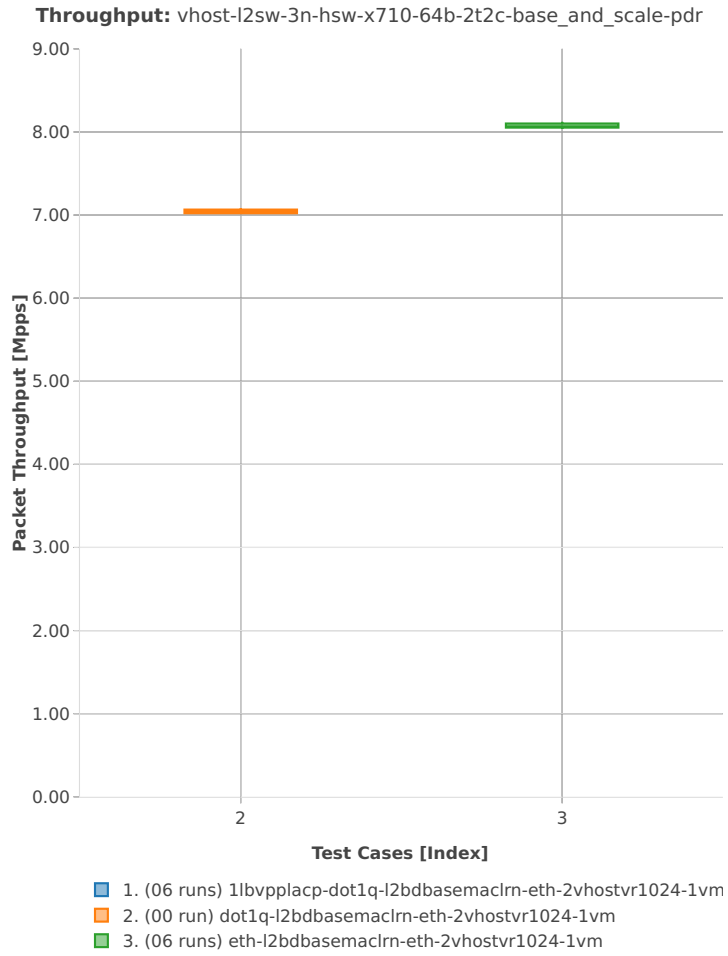

64b-1t1c-base-vm-l2sw

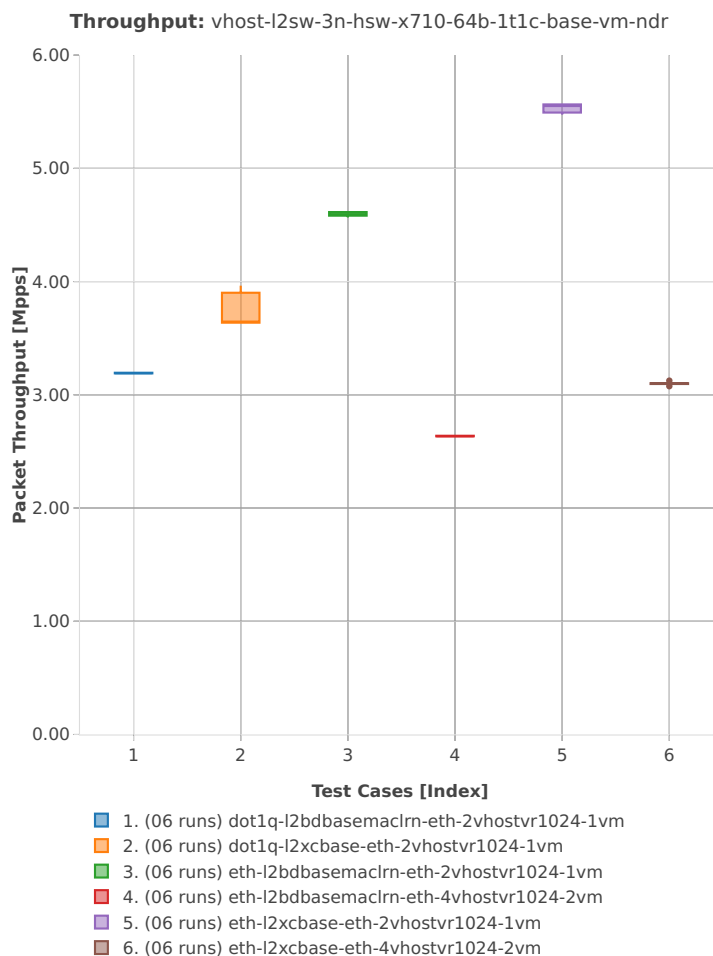

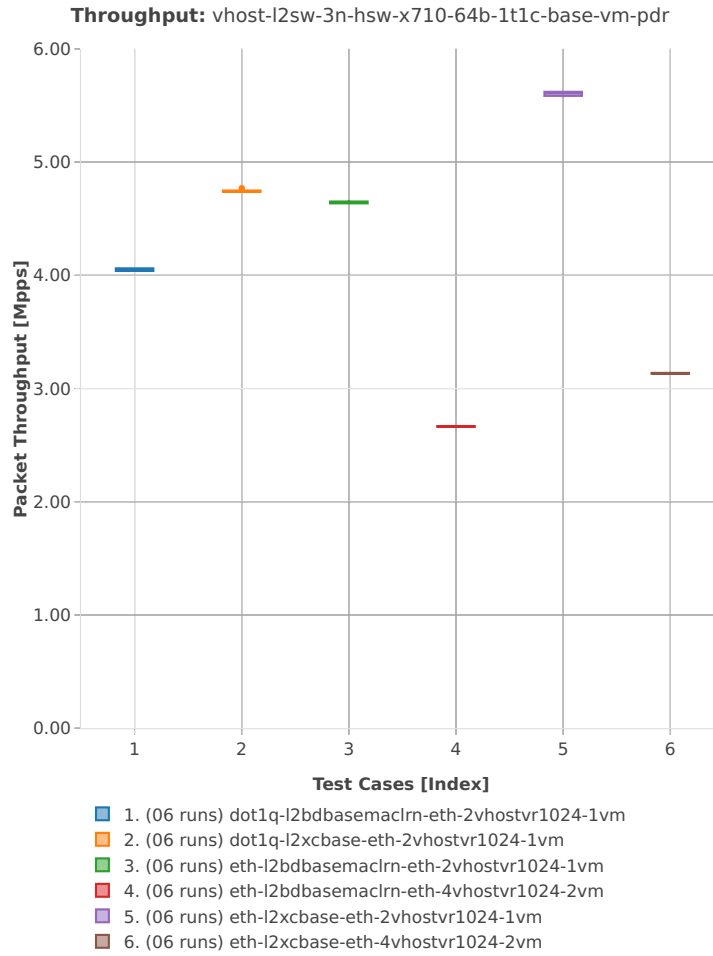

64b-2t2c-base-vm-l2sw

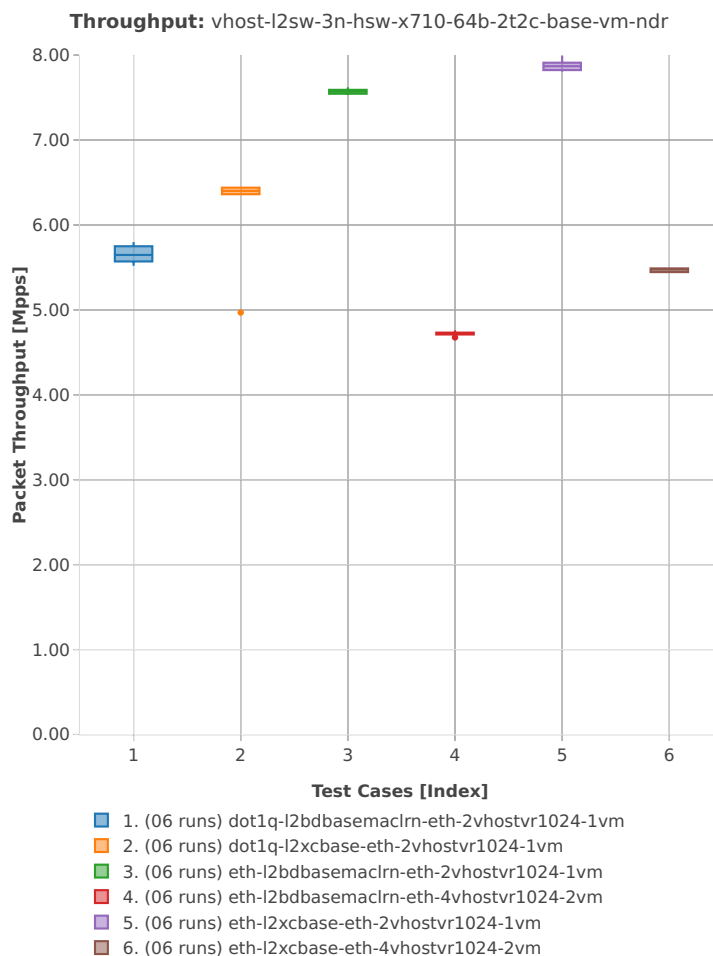

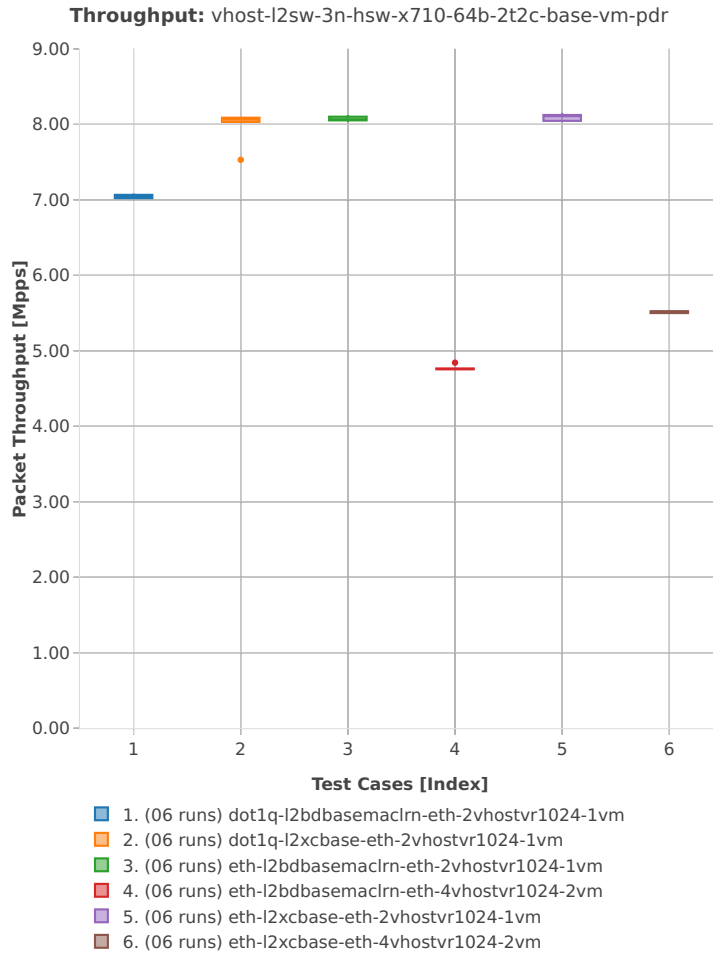

64b-1t1c-base\_and\_scale-ip4

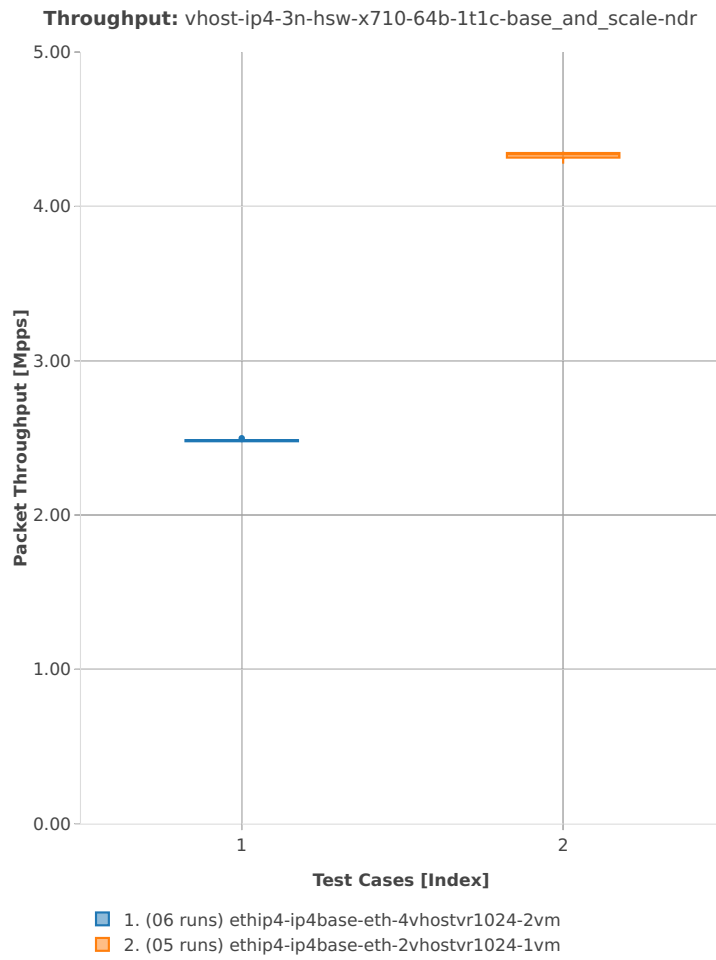

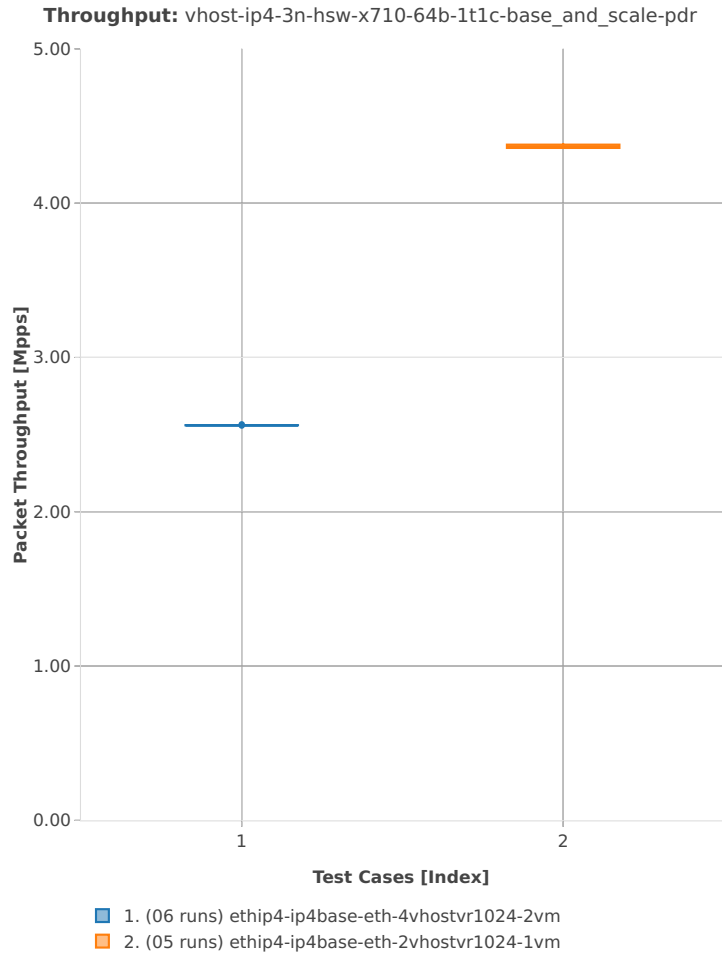



64b-2t2c-base\_and\_scale-ip4

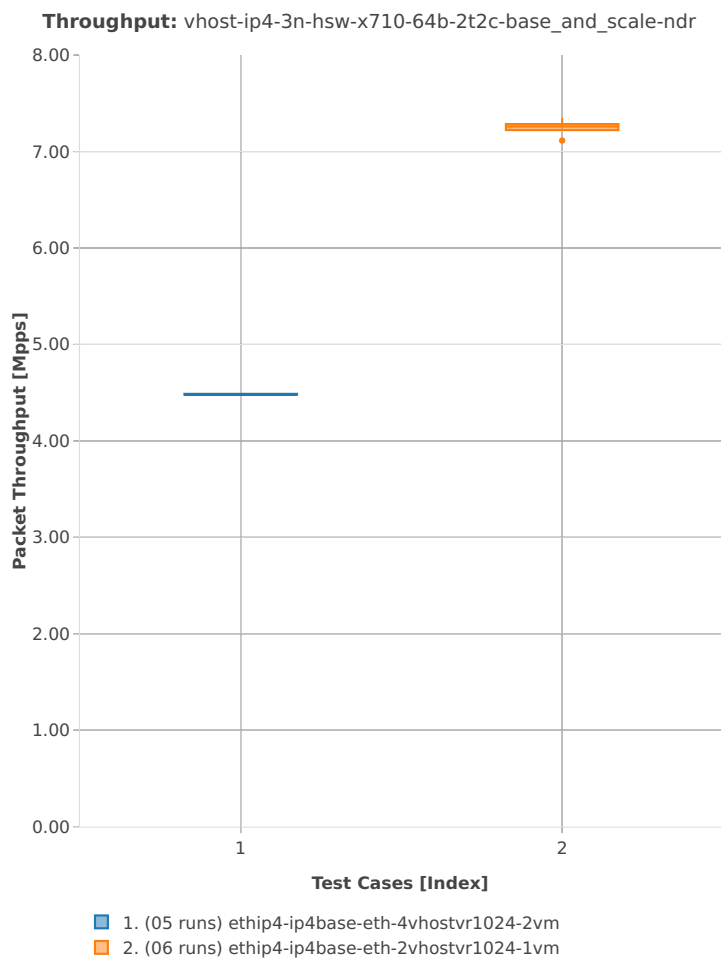

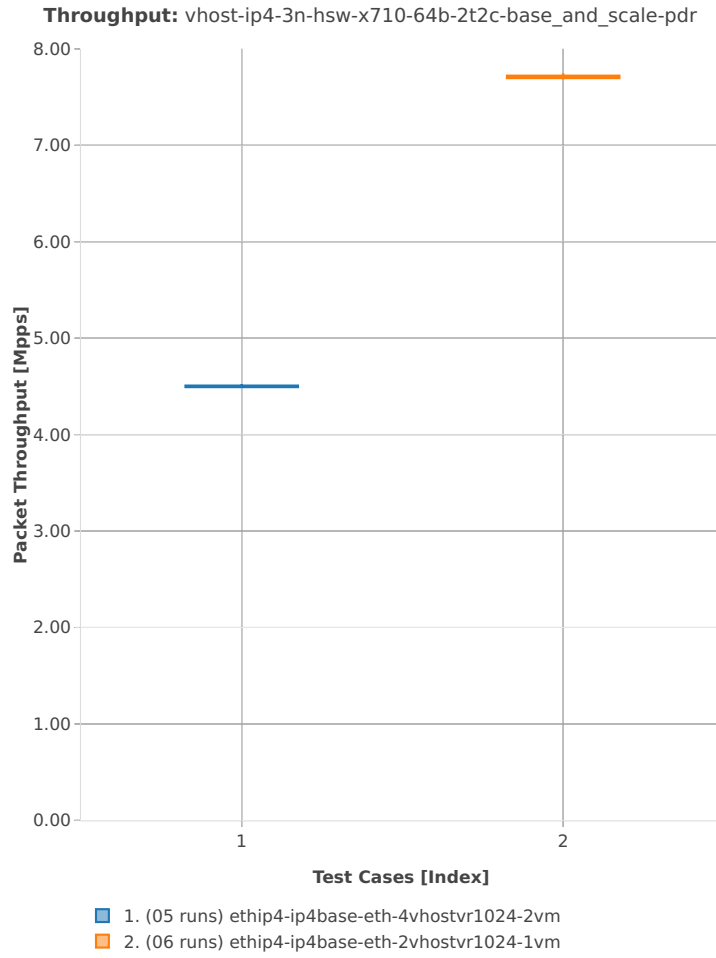

3n-skx-x710

64b-2t1c-base-l2sw

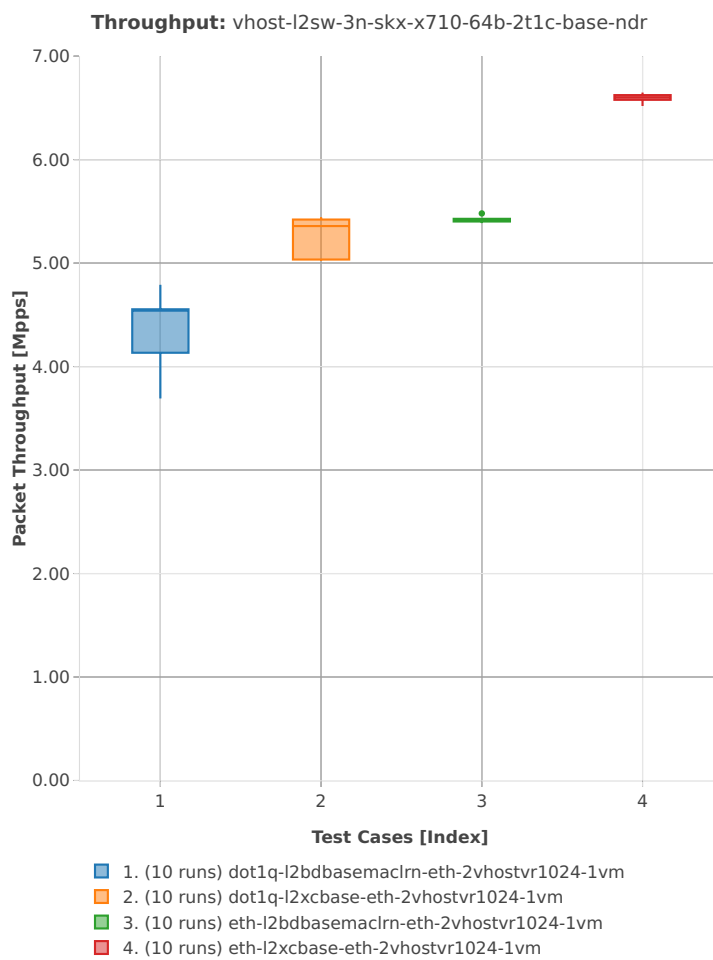

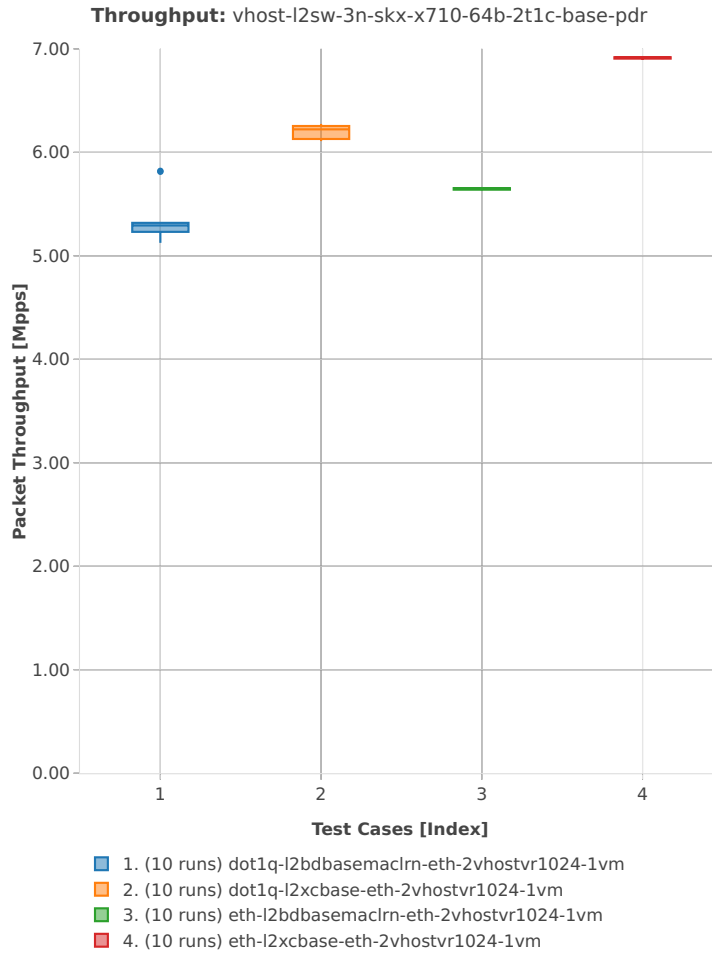

64b-4t2c-base-l2sw

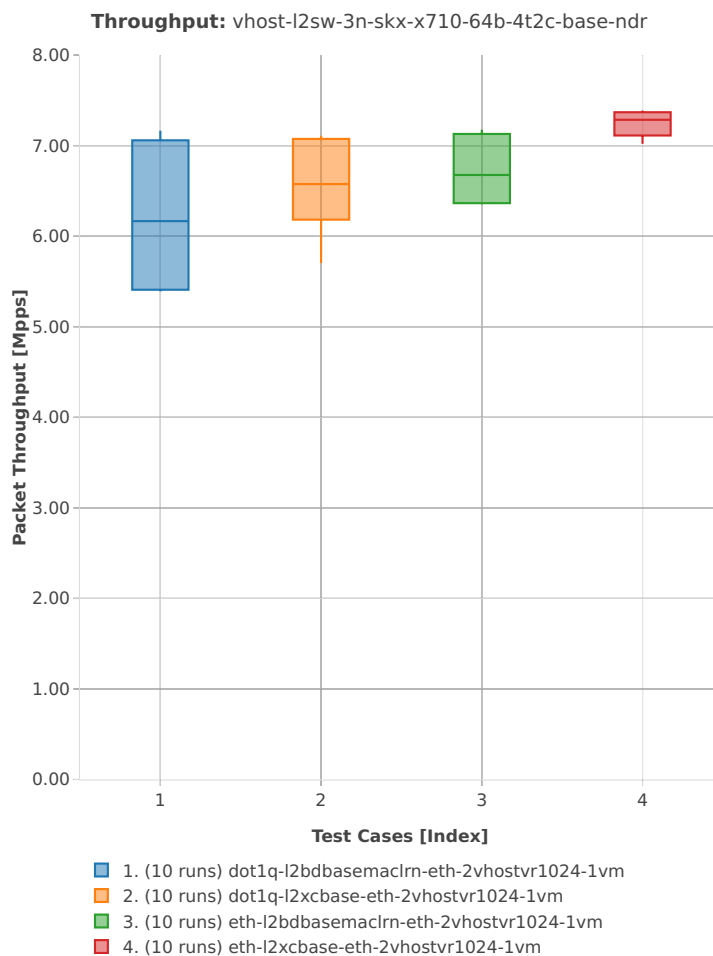

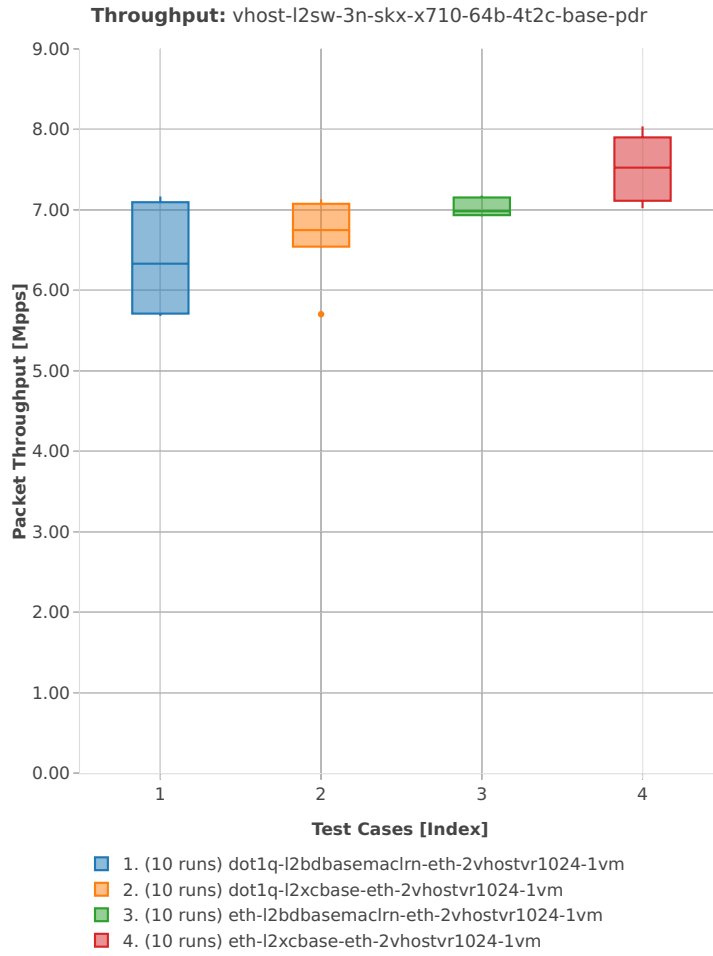

64b-2t1c-base\_and\_scale-l2sw

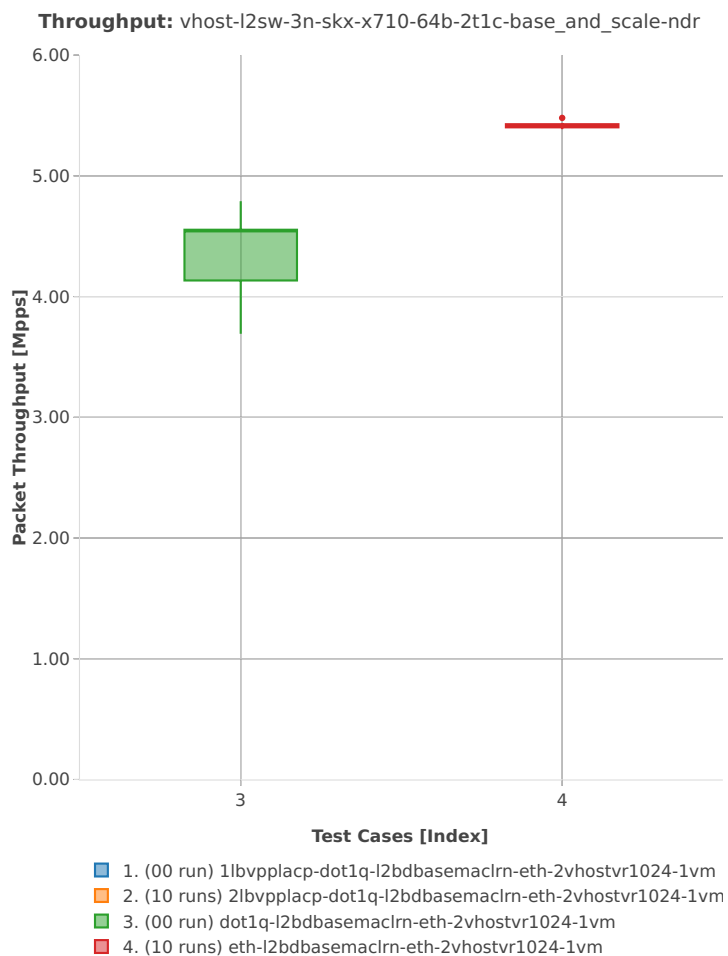

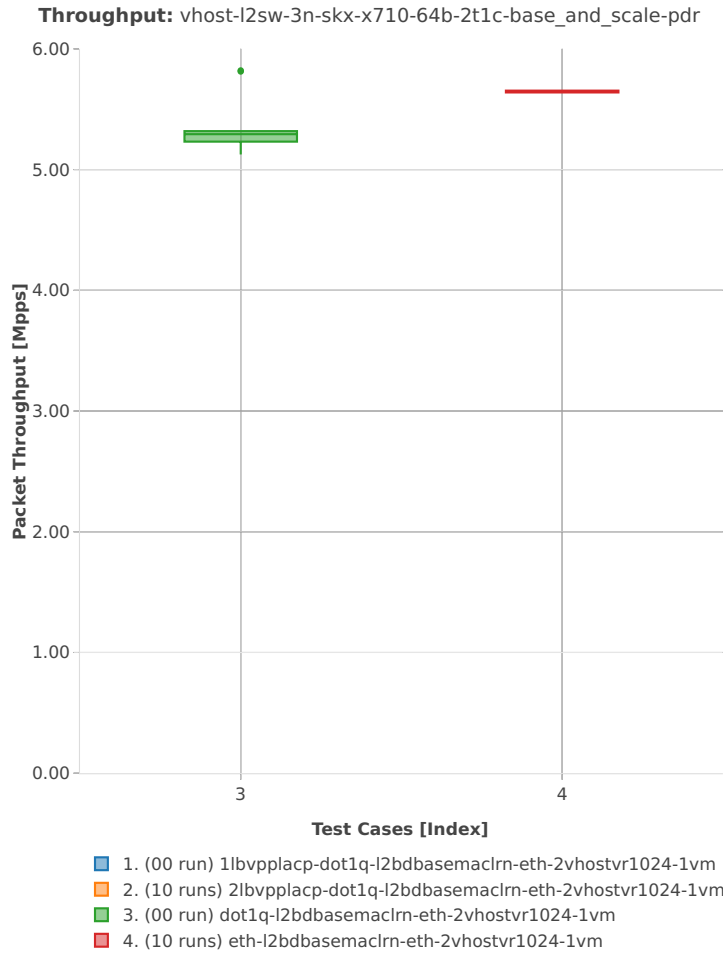



64b-4t2c-base\_and\_scale-l2sw

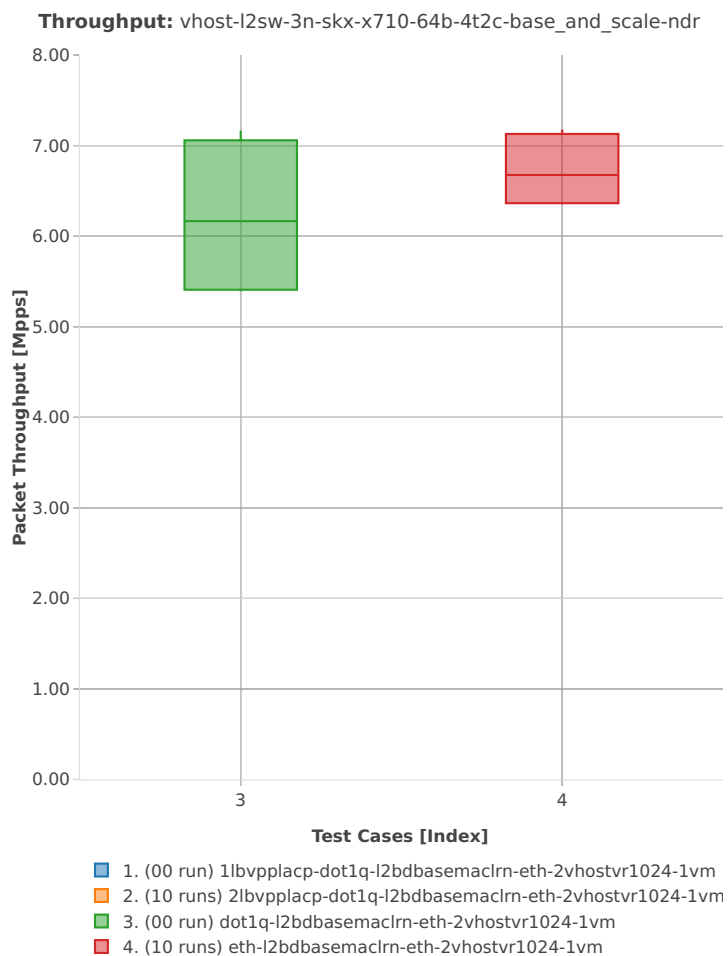

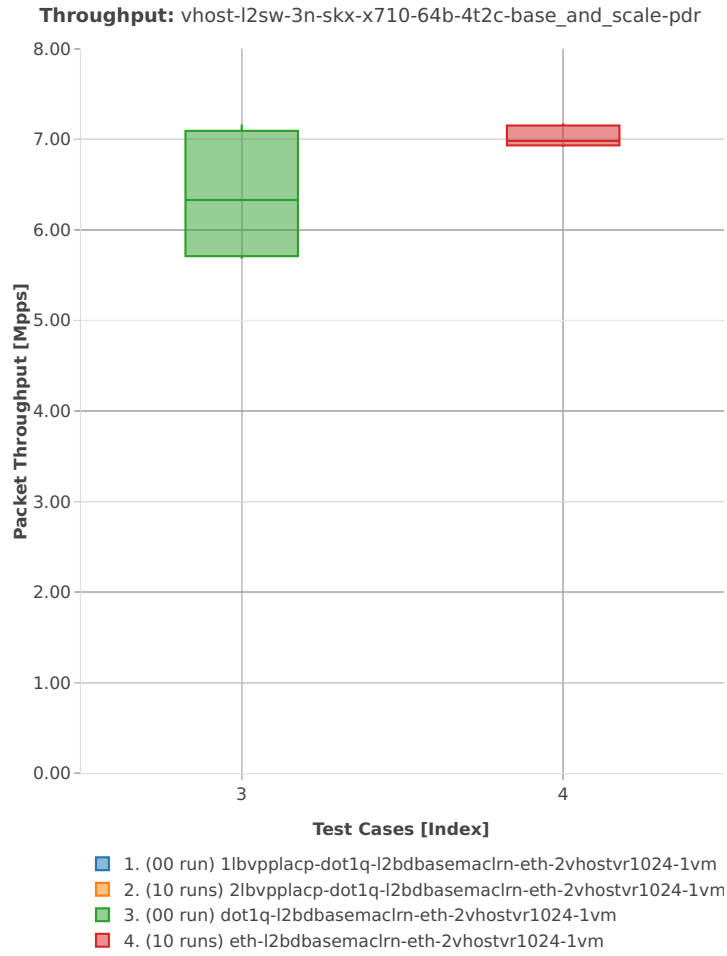

64b-2t1c-base-vm-l2sw

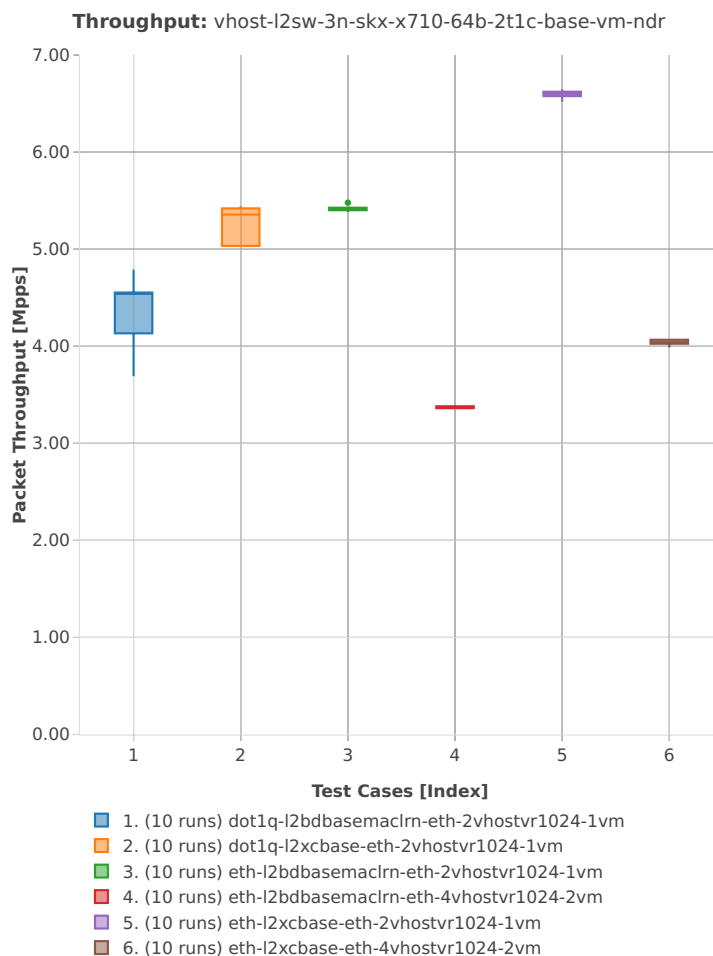

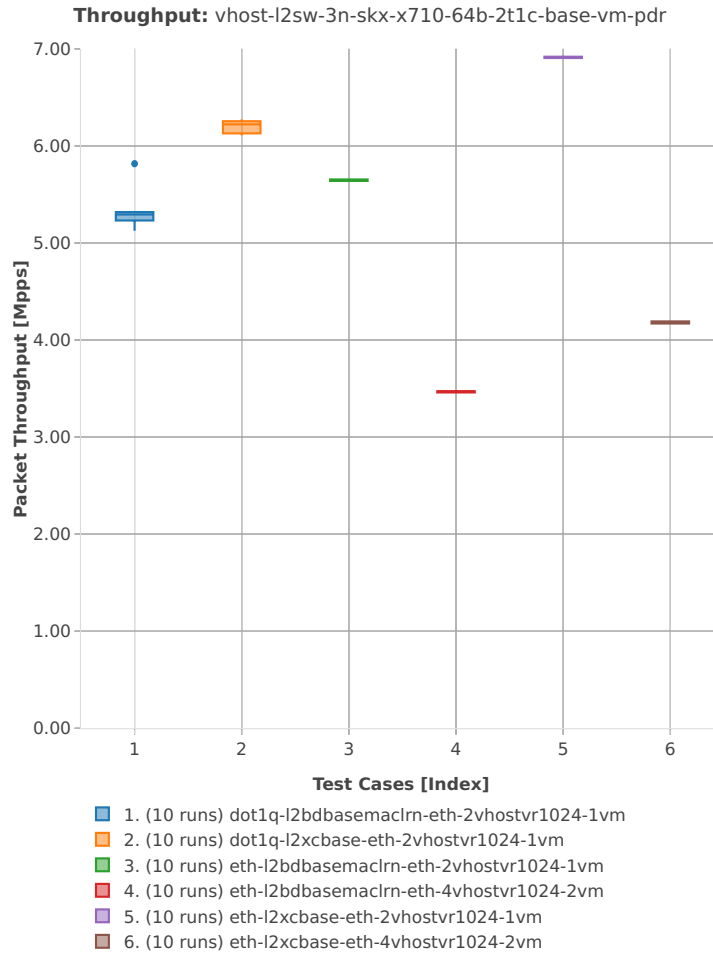

64b-4t2c-base-vm-l2sw

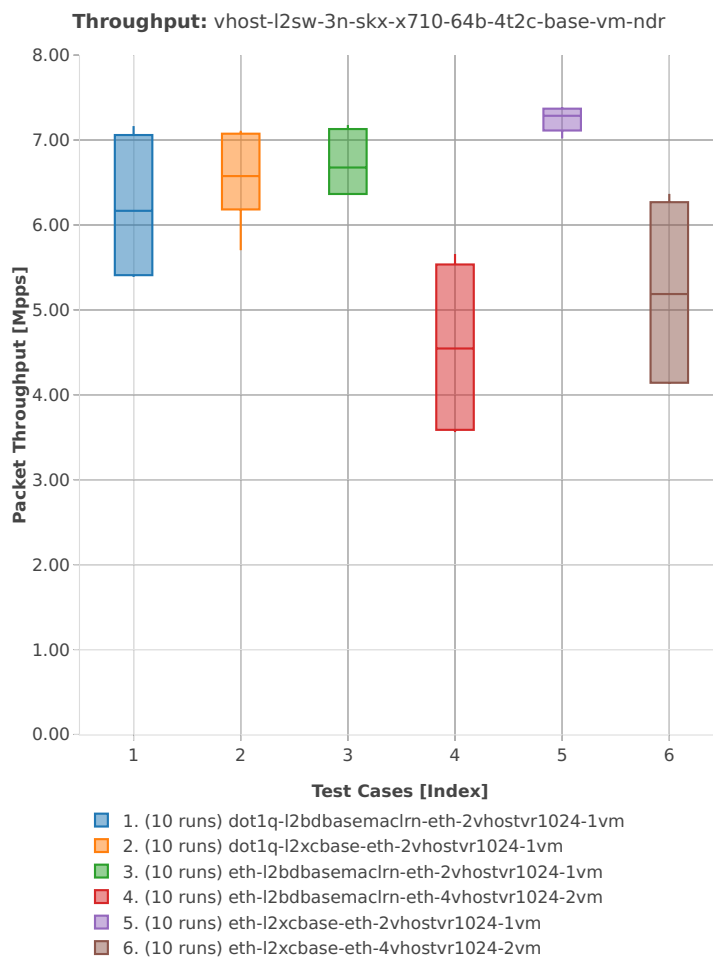

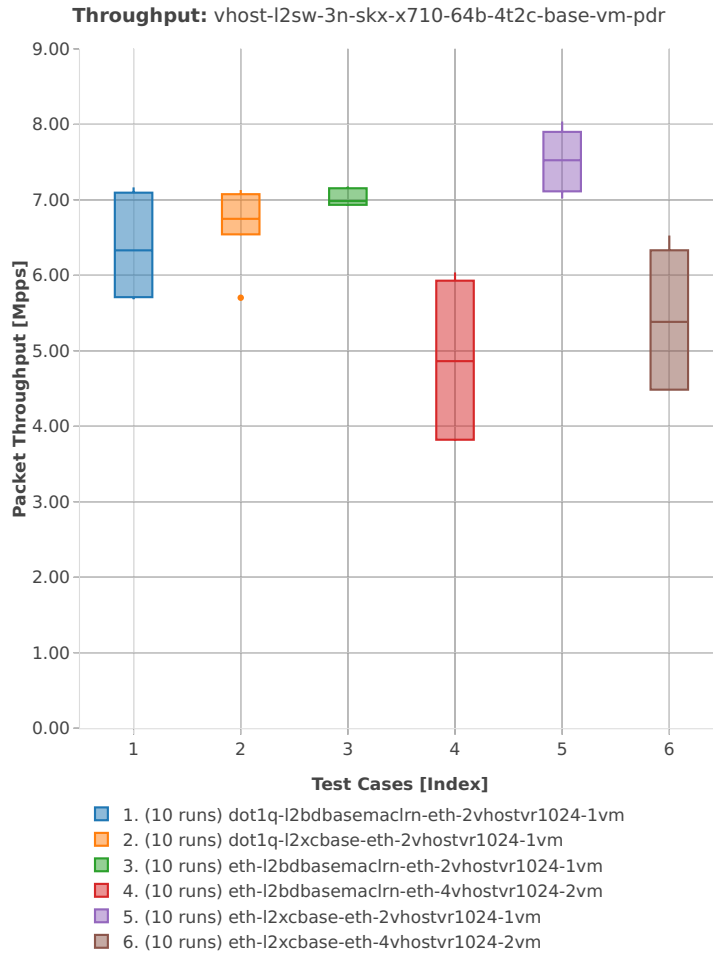

64b-2t1c-base\_and\_scale-ip4

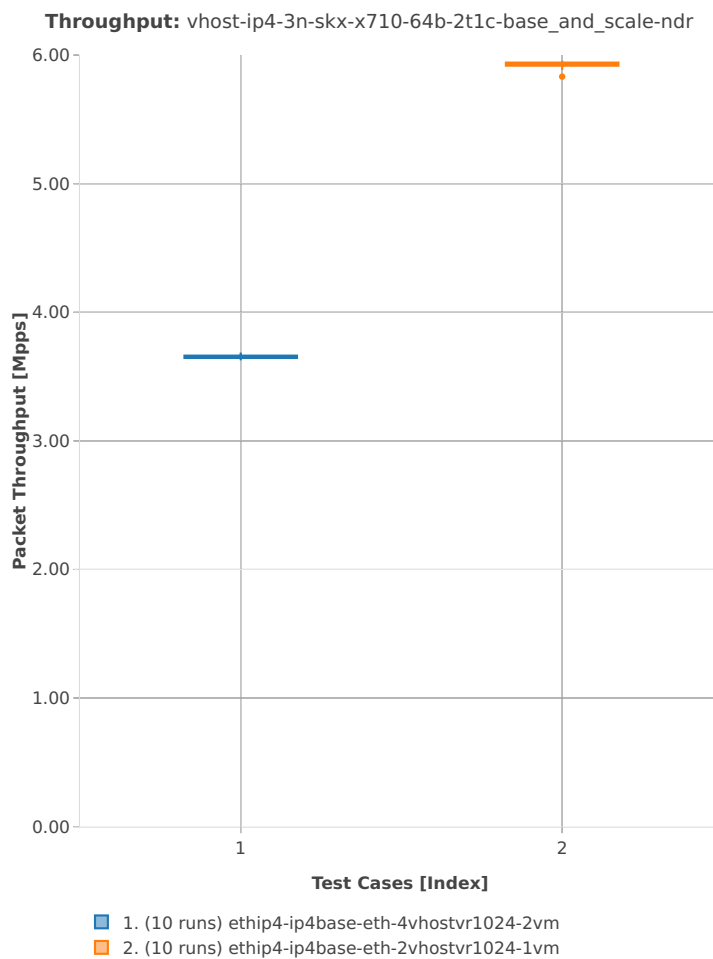

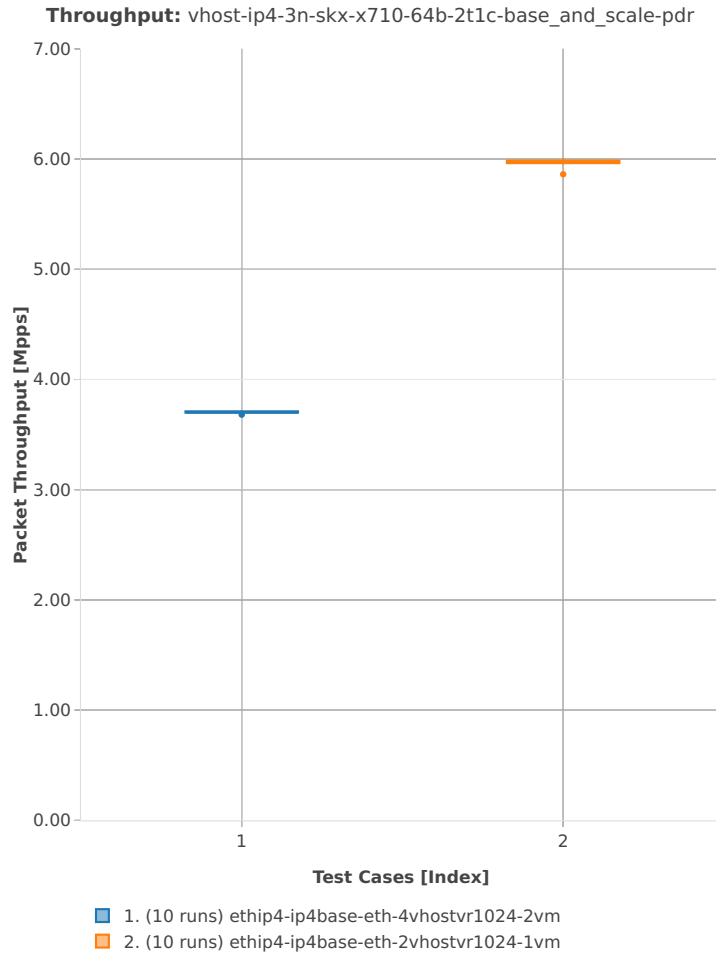



64b-4t2c-base\_and\_scale-ip4

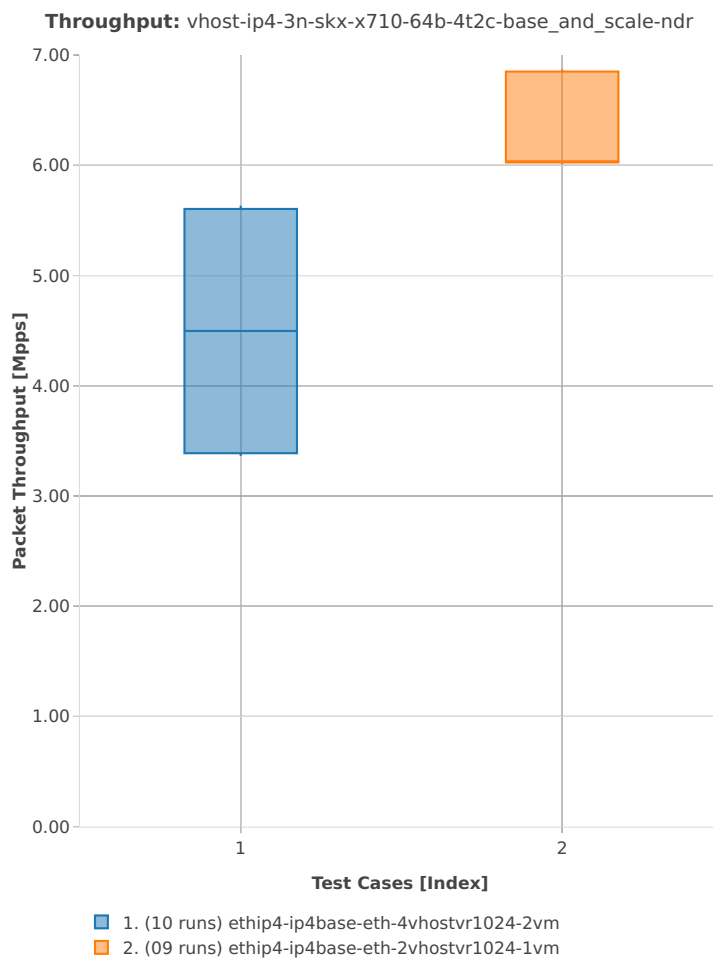

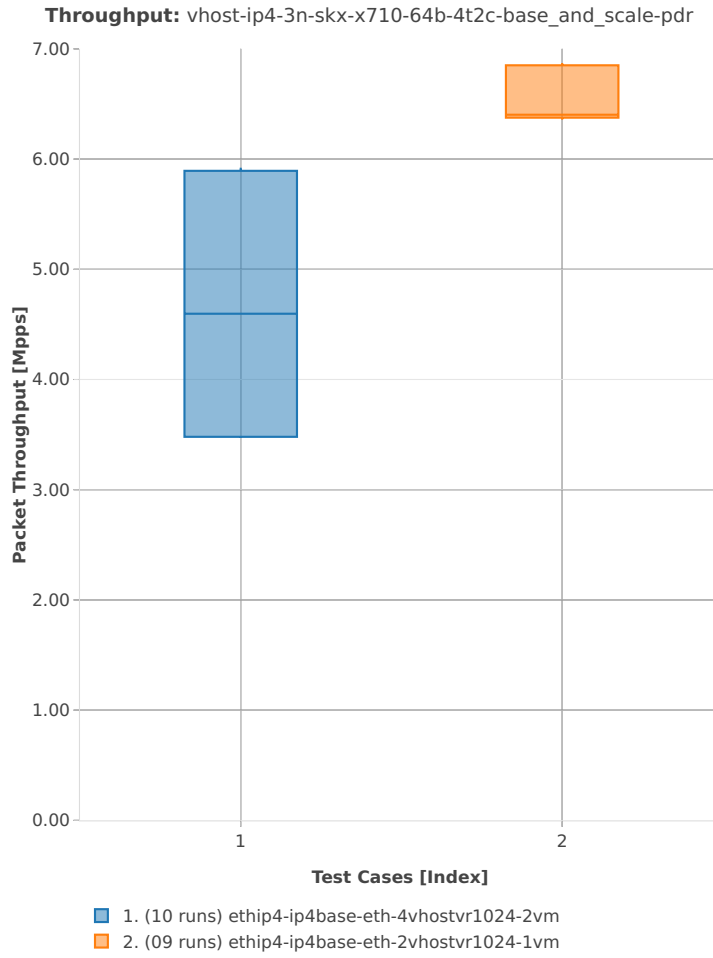

2n-skx-x710

64b-2t1c-base-l2sw

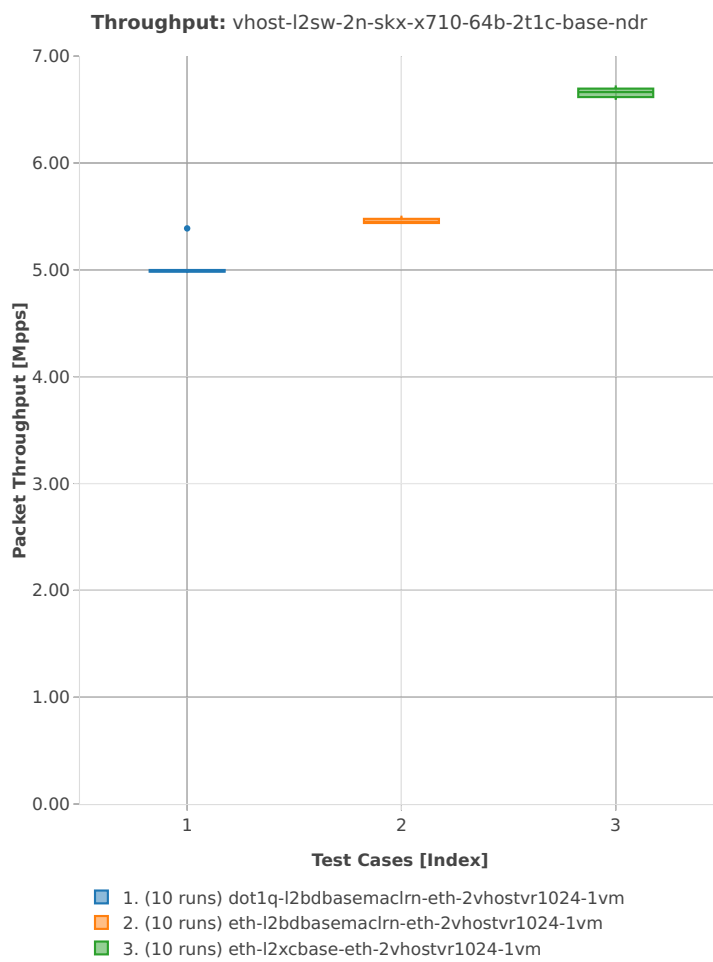

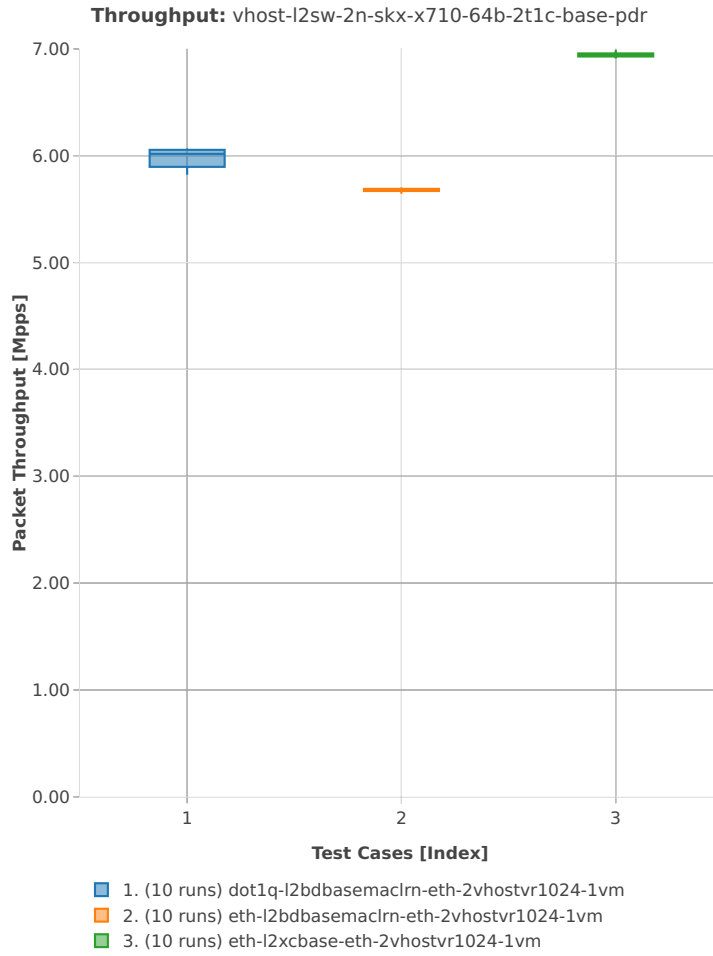

64b-4t2c-base-l2sw

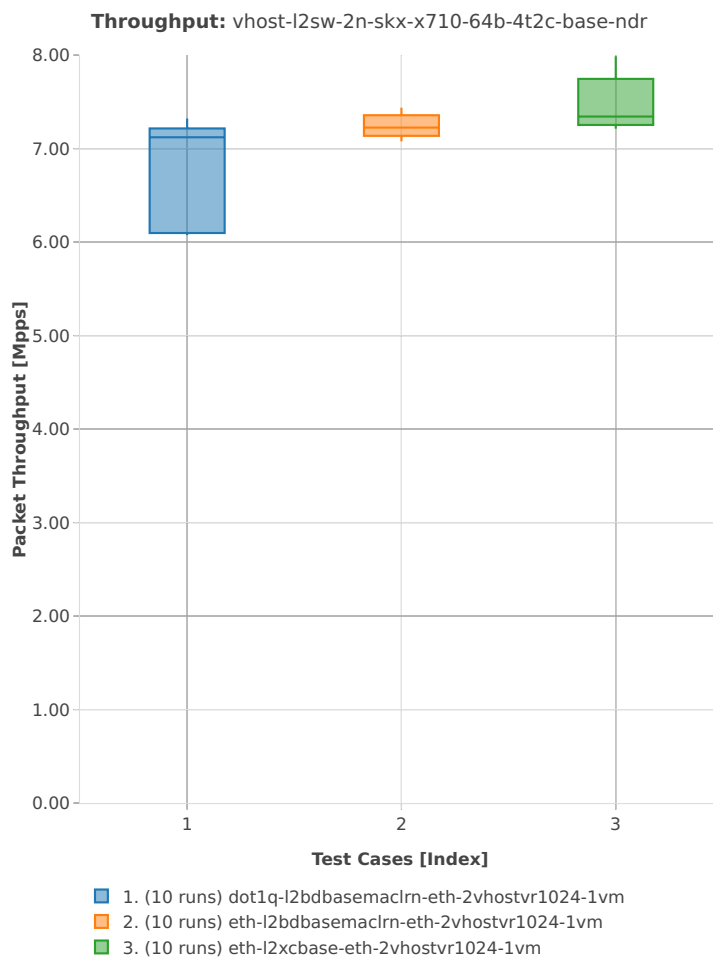

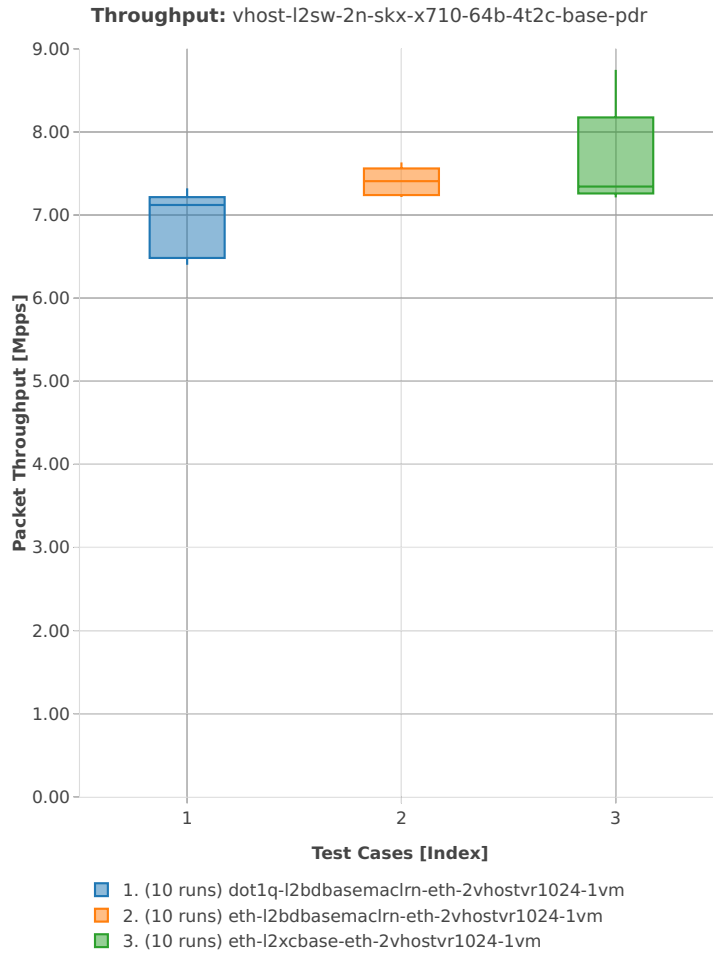

64b-2t1c-base\_and\_scale-l2sw

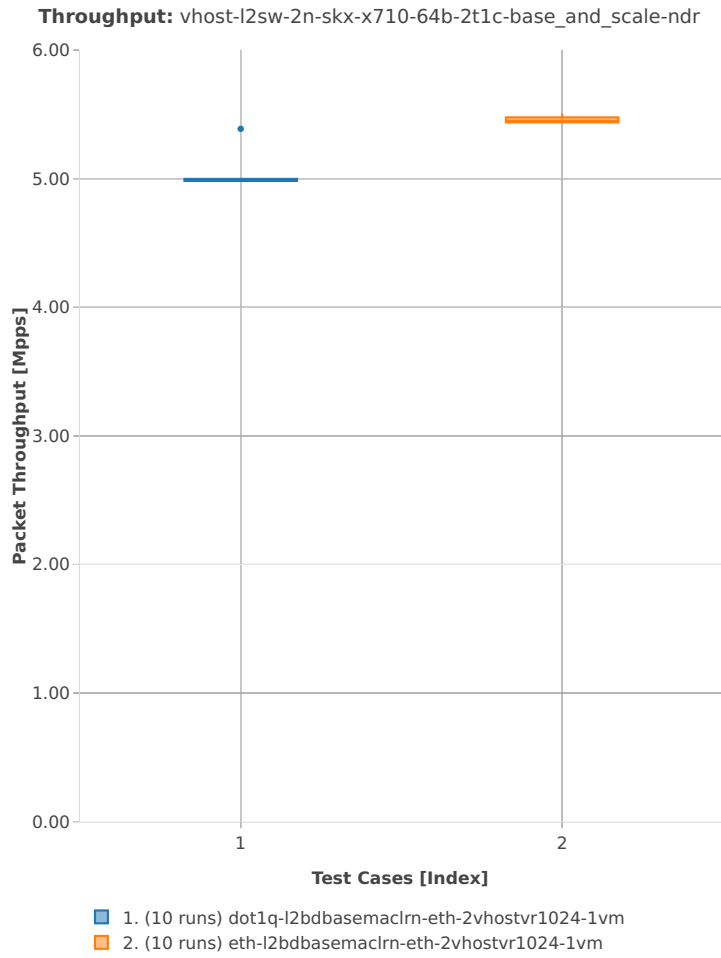

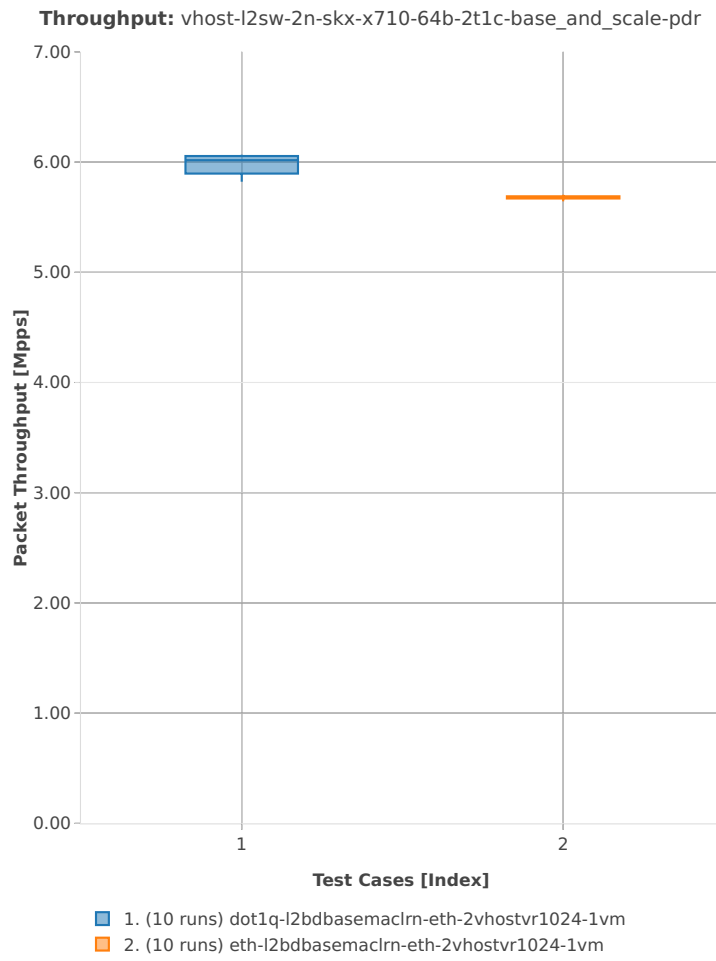



64b-4t2c-base\_and\_scale-l2sw

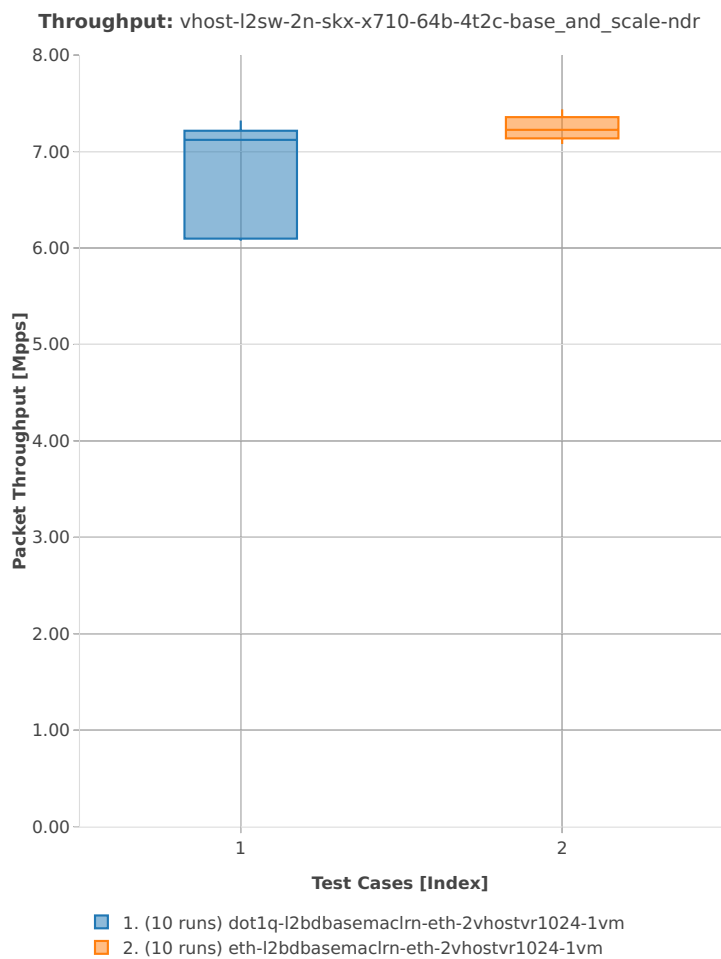

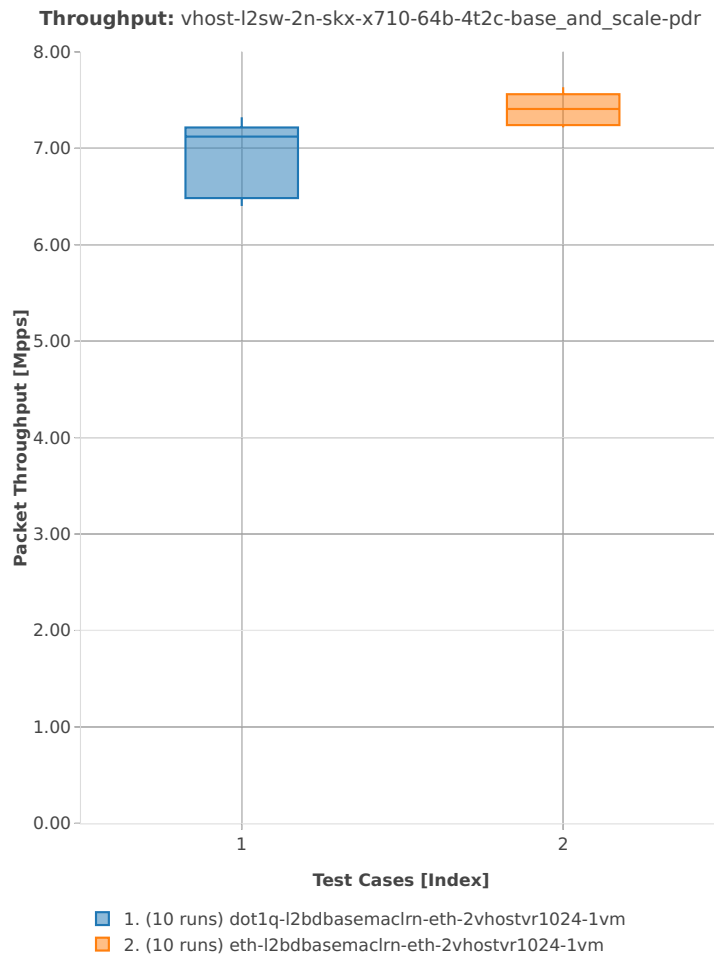

64b-2t1c-base-vm-l2sw

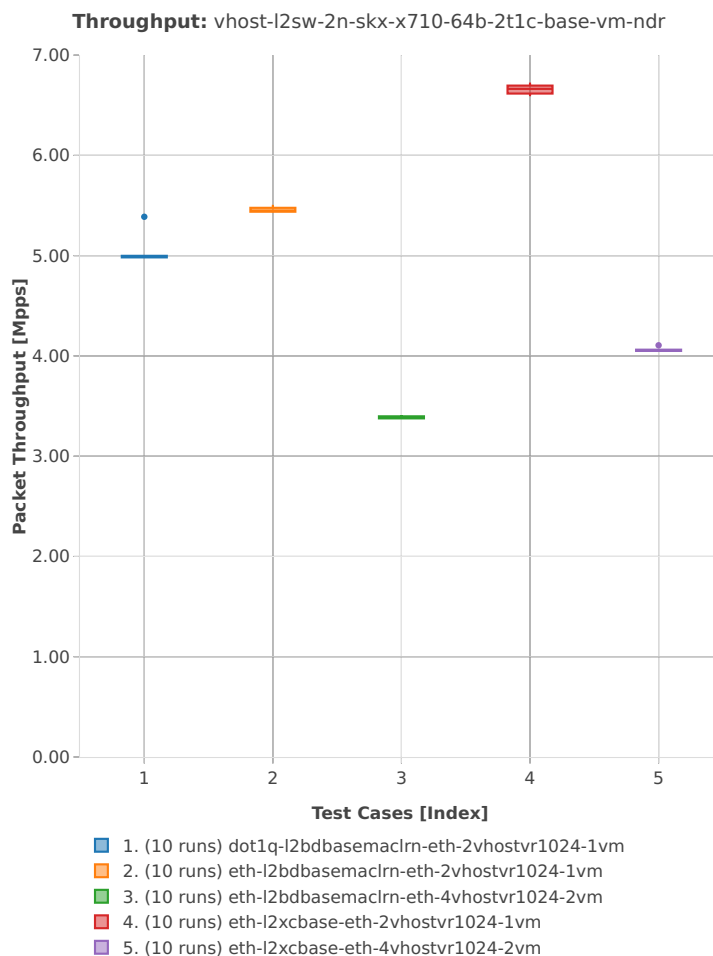

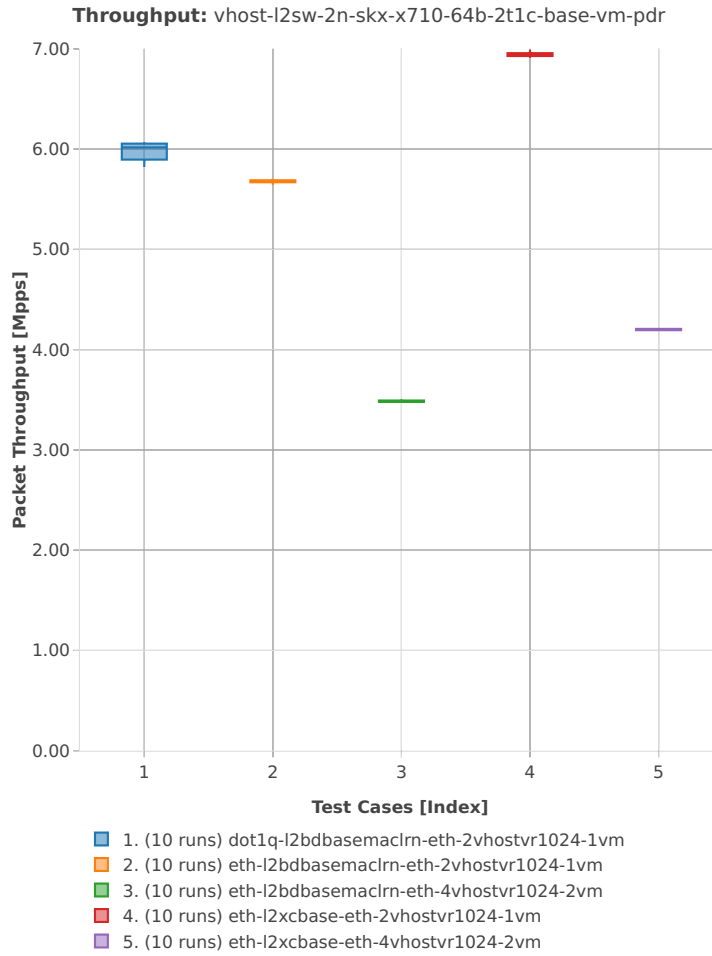

64b-4t2c-base-vm-l2sw

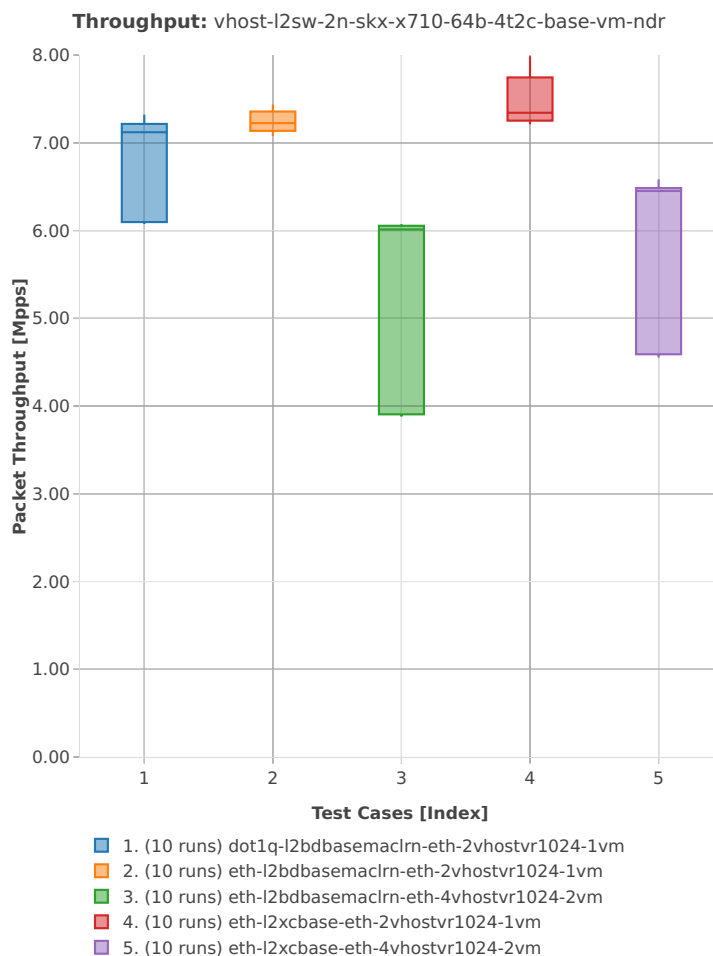

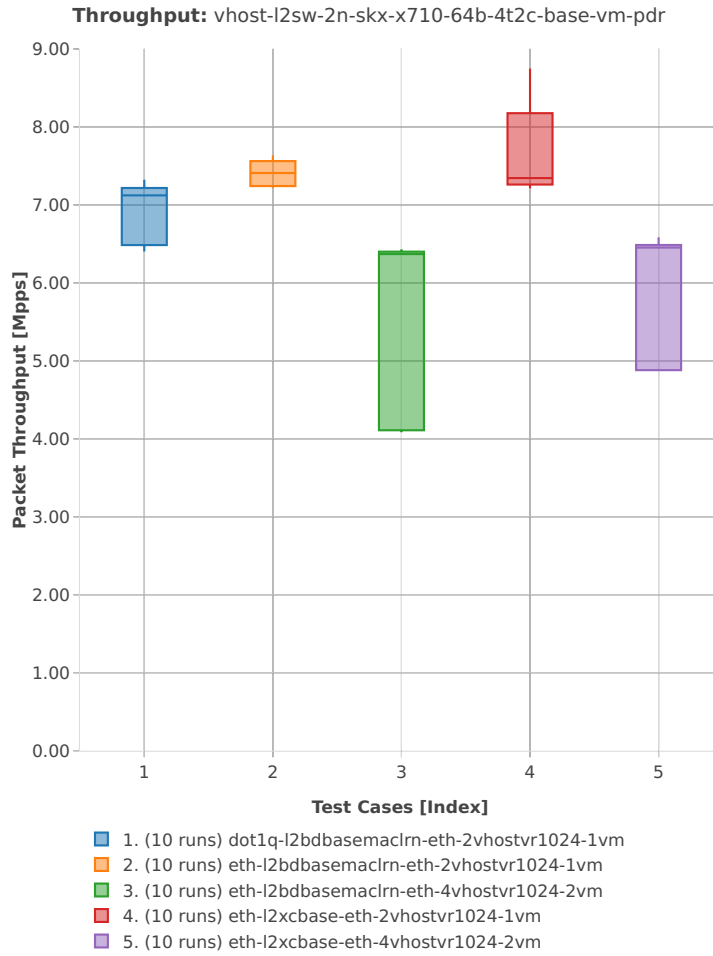

64b-2t1c-base\_and\_scale-ip4

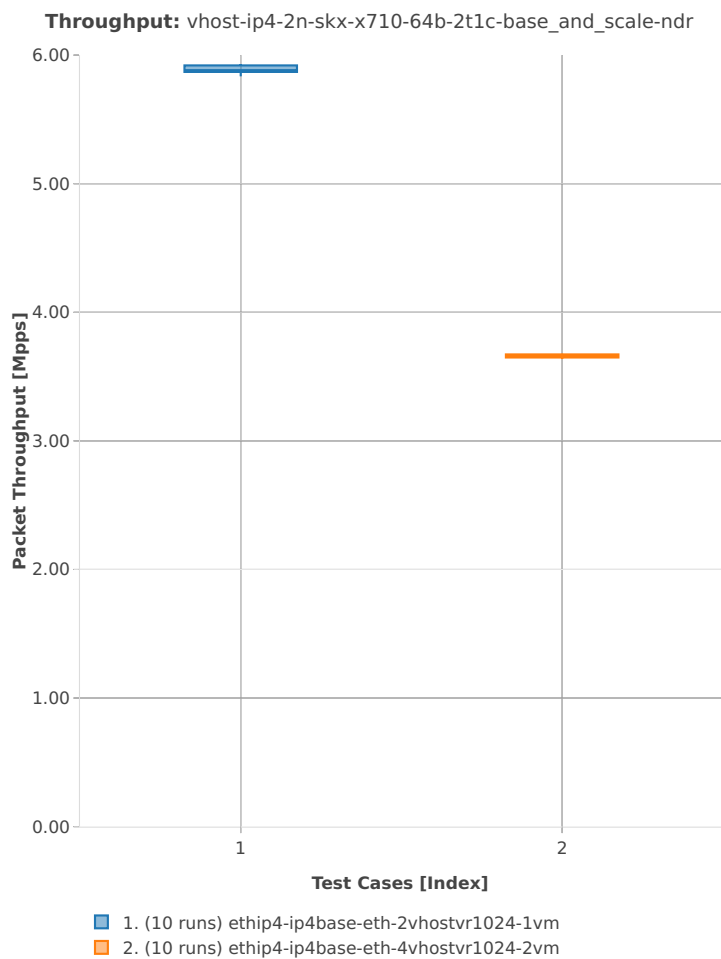

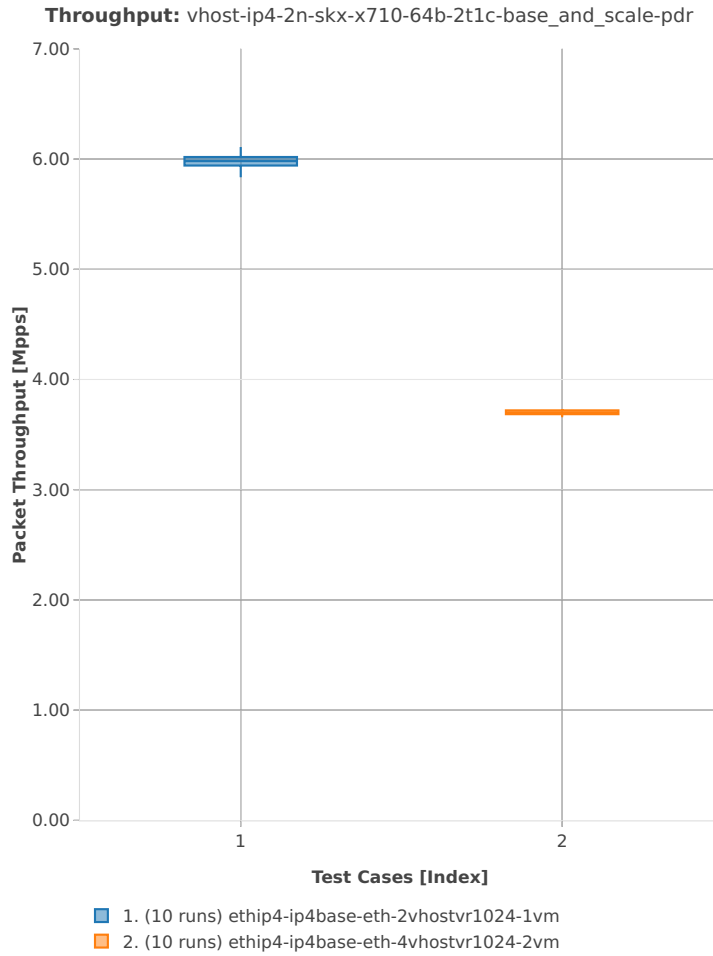



64b-4t2c-base\_and\_scale-ip4

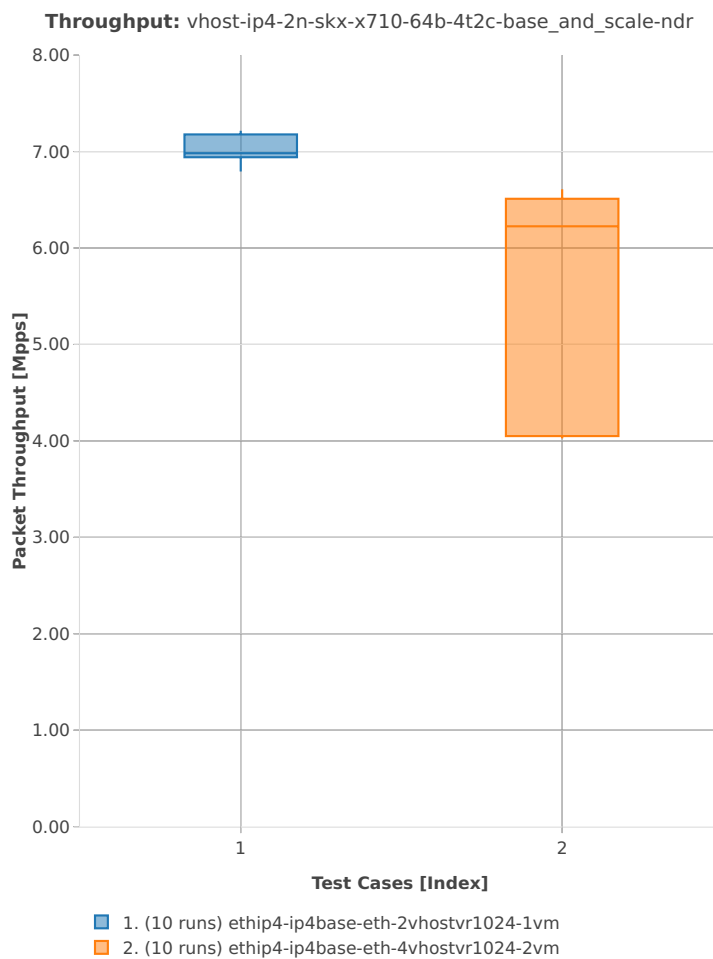

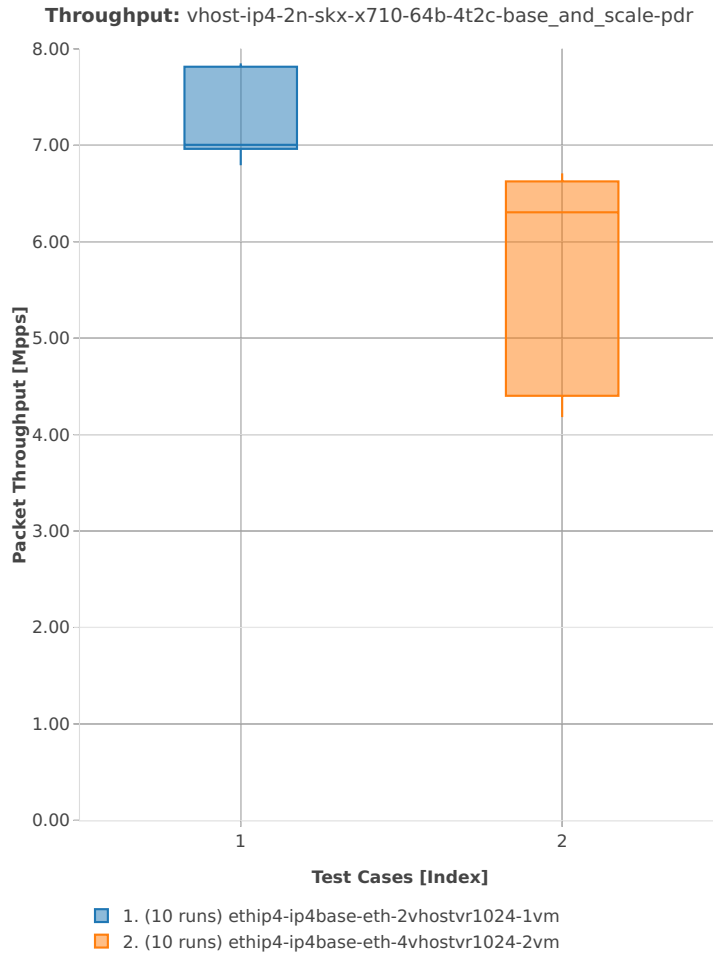

2n-skx-xxv710

64b-2t1c-base-l2sw

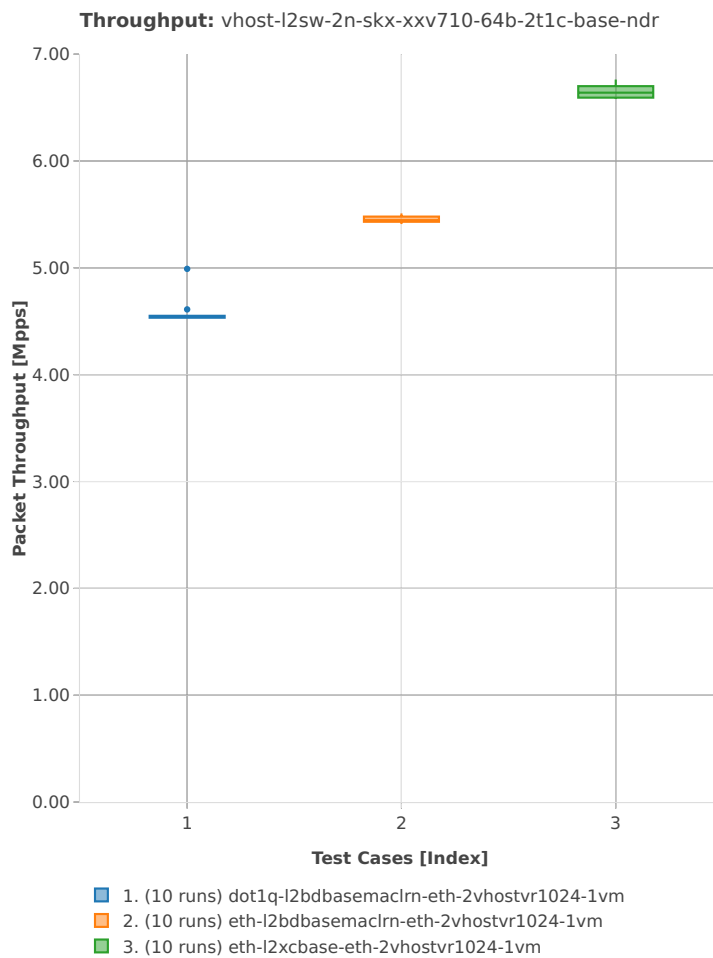

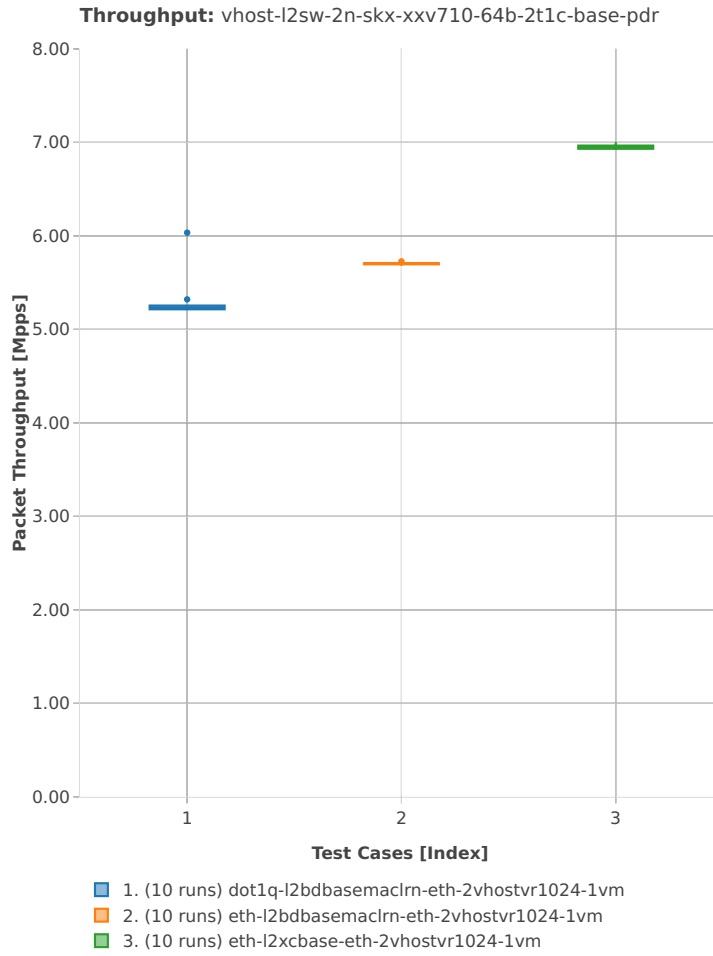

64b-4t2c-base-l2sw

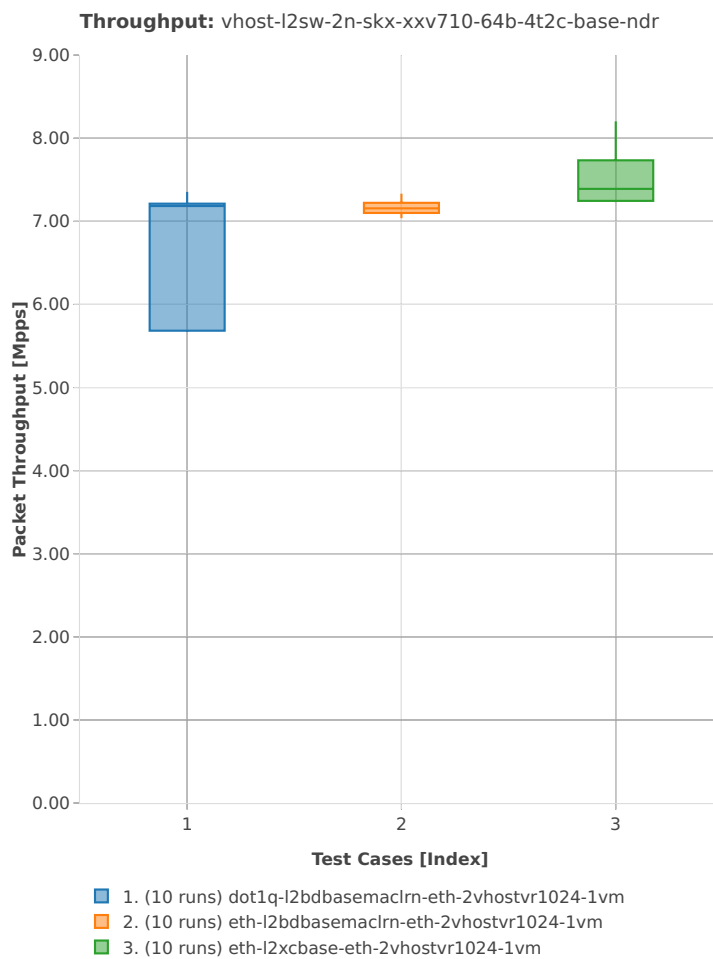

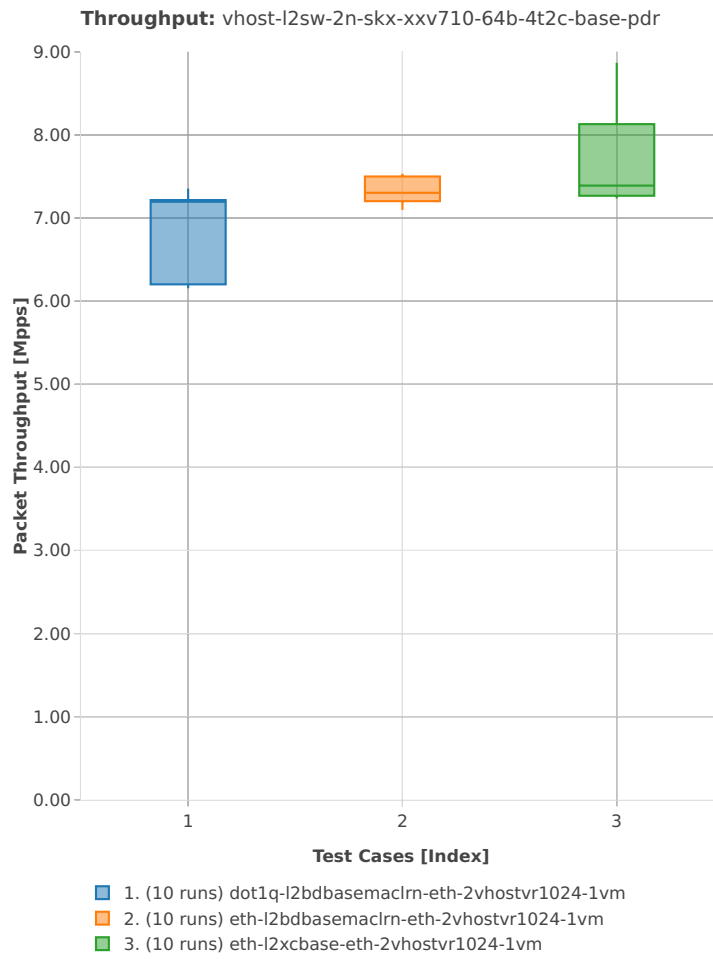

64b-2t1c-base\_and\_scale-l2sw

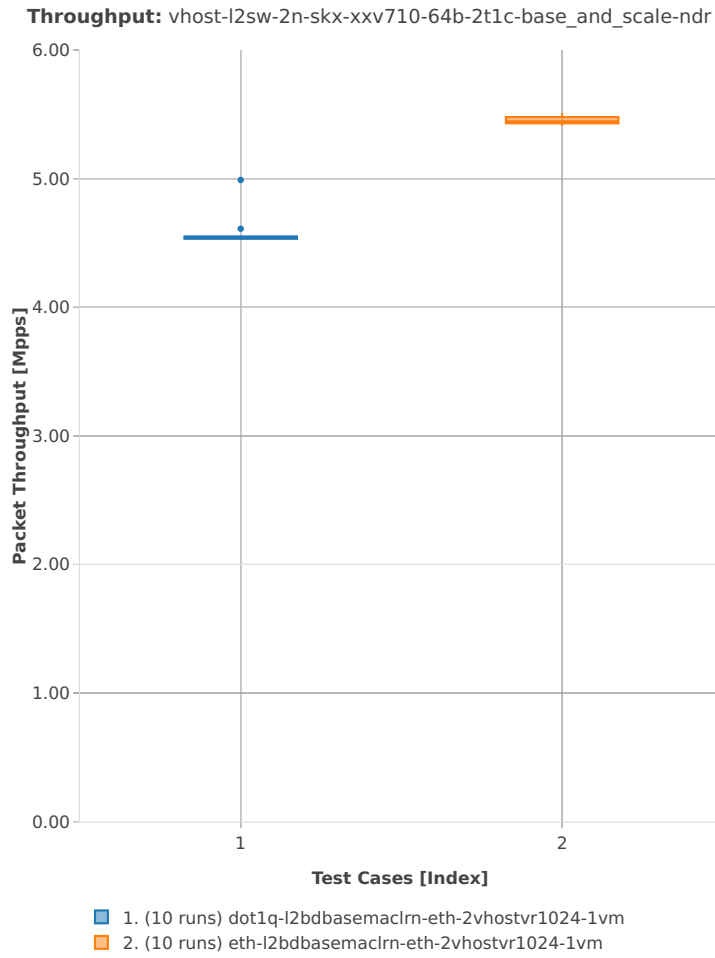

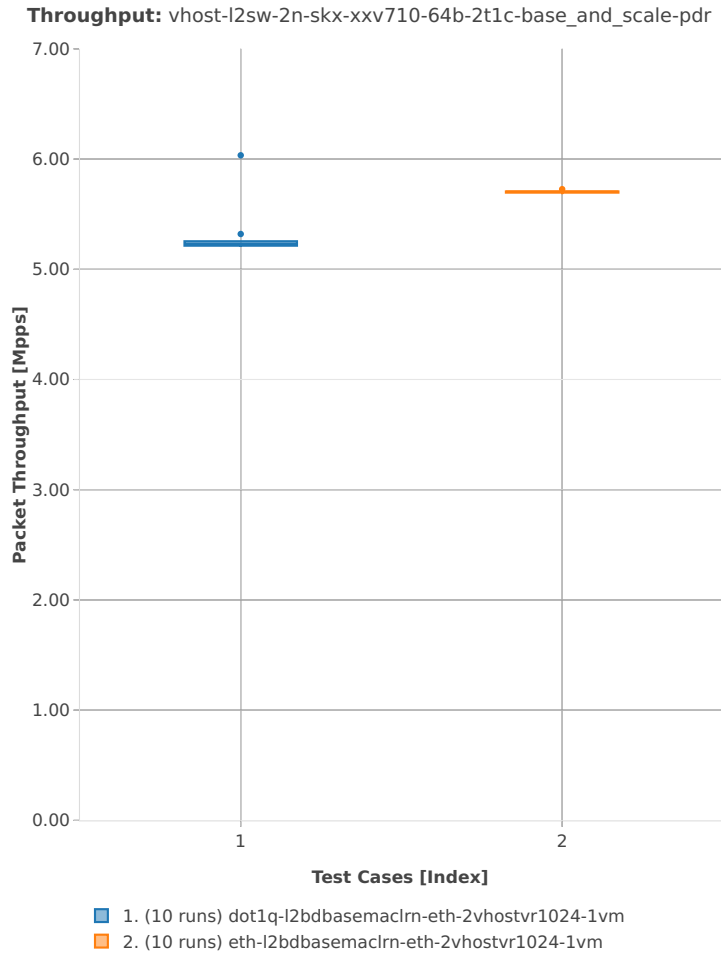



64b-4t2c-base\_and\_scale-l2sw

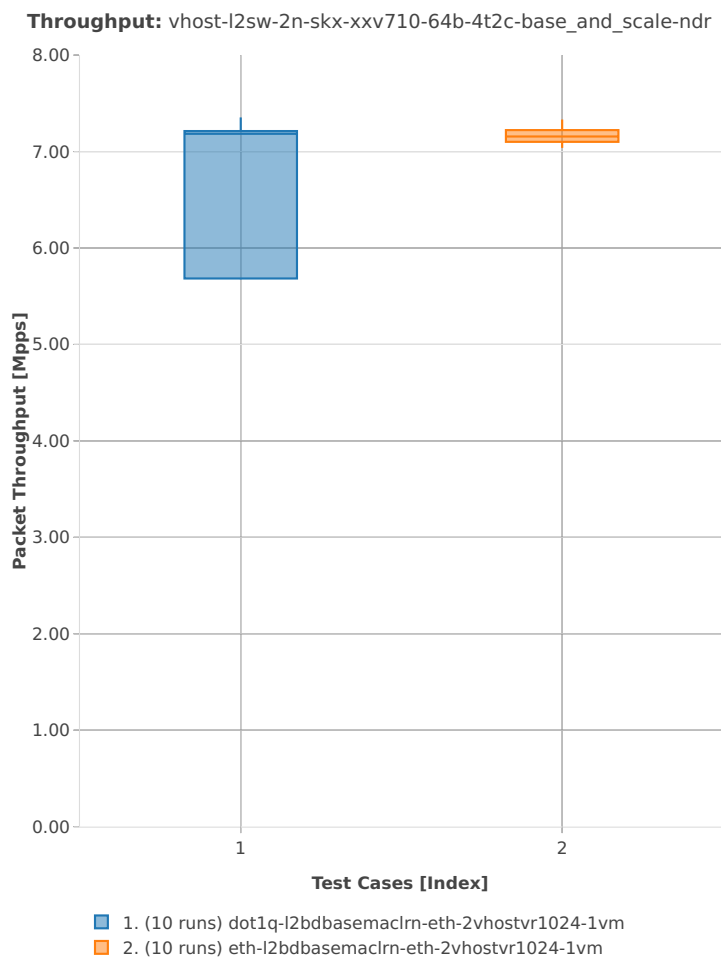

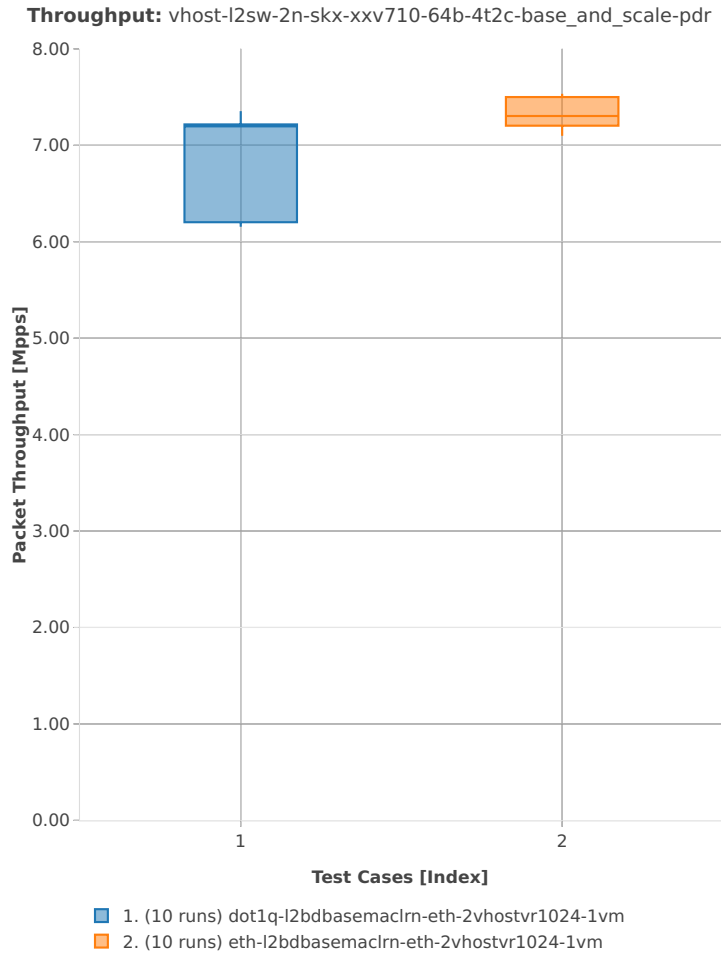

64b-2t1c-base-vm-l2sw

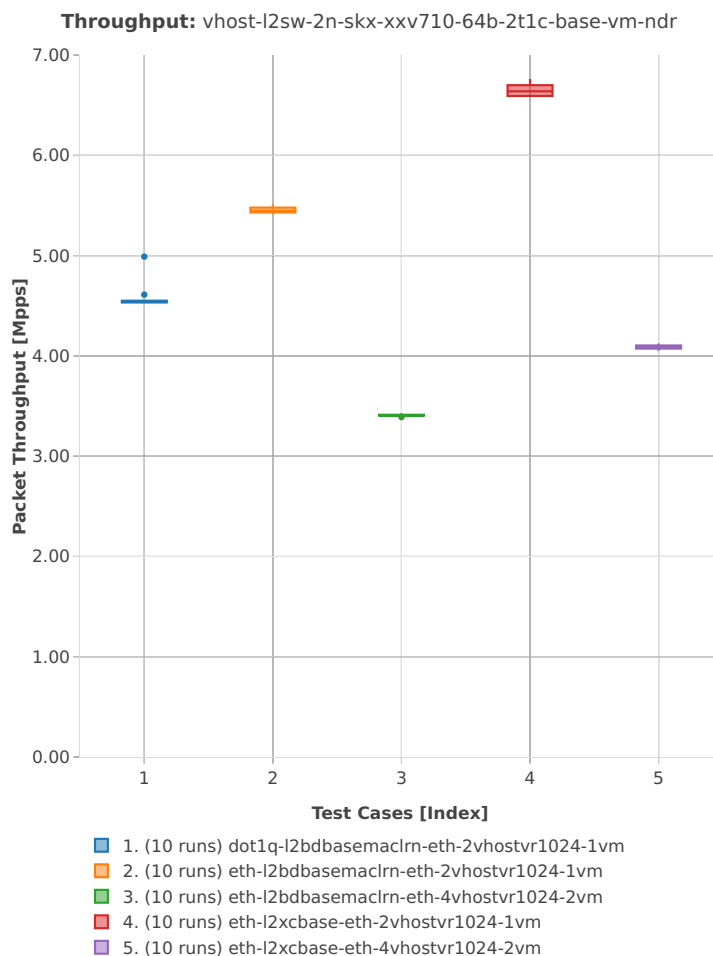

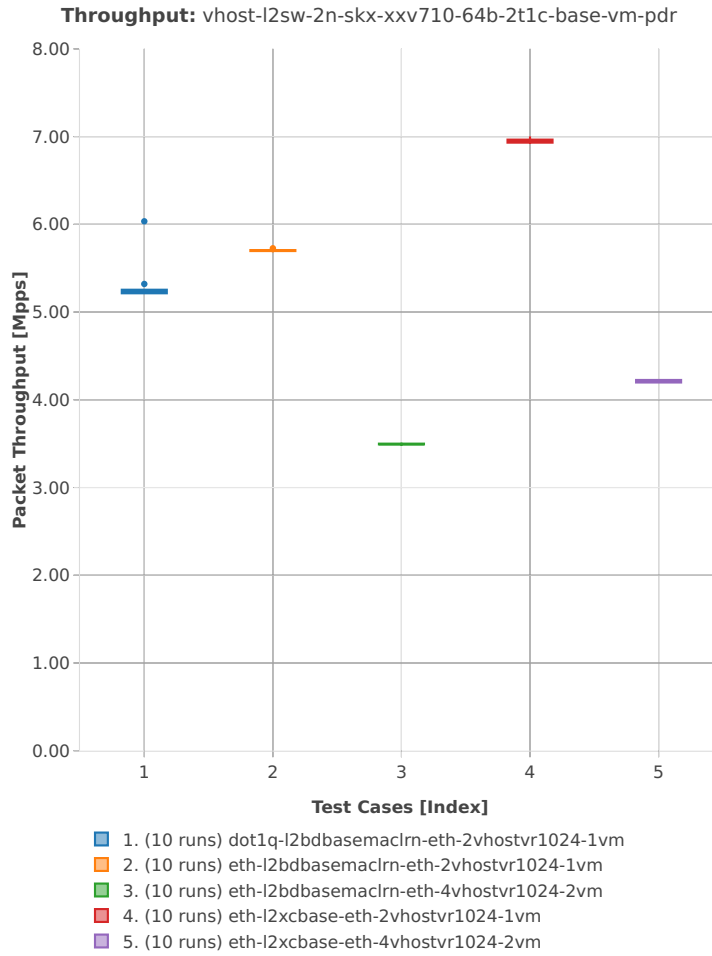

64b-4t2c-base-vm-l2sw

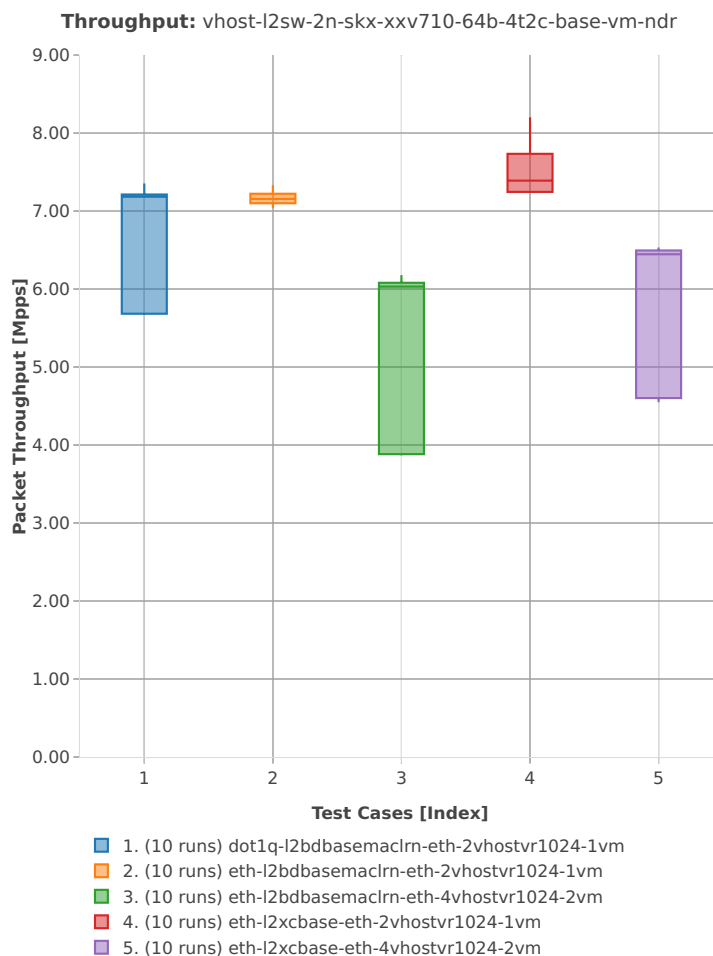

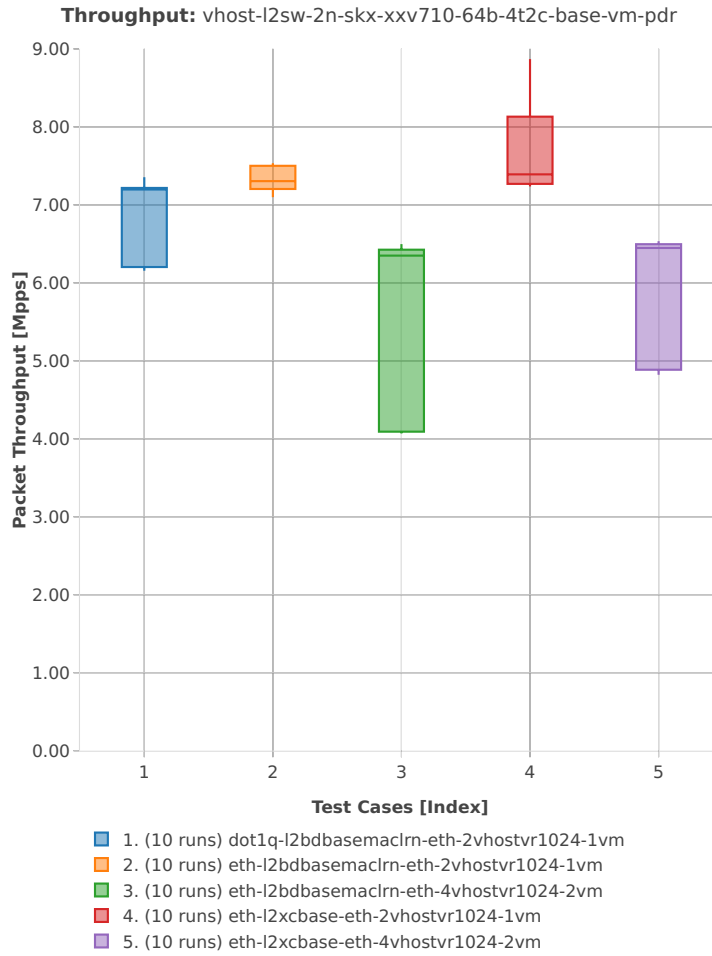

64b-2t1c-base\_and\_scale-ip4

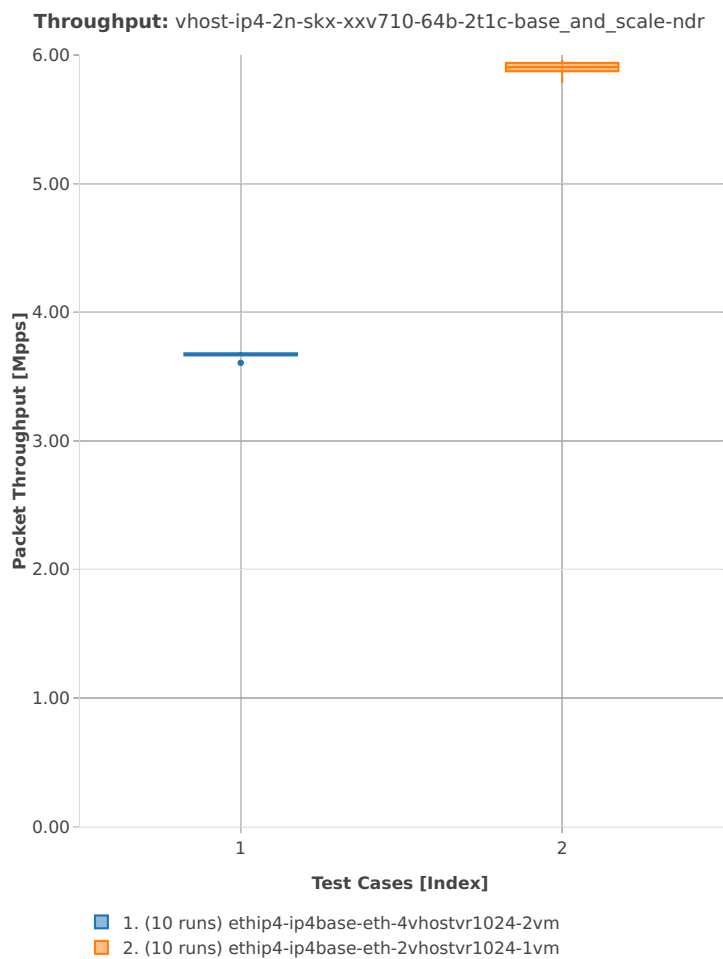

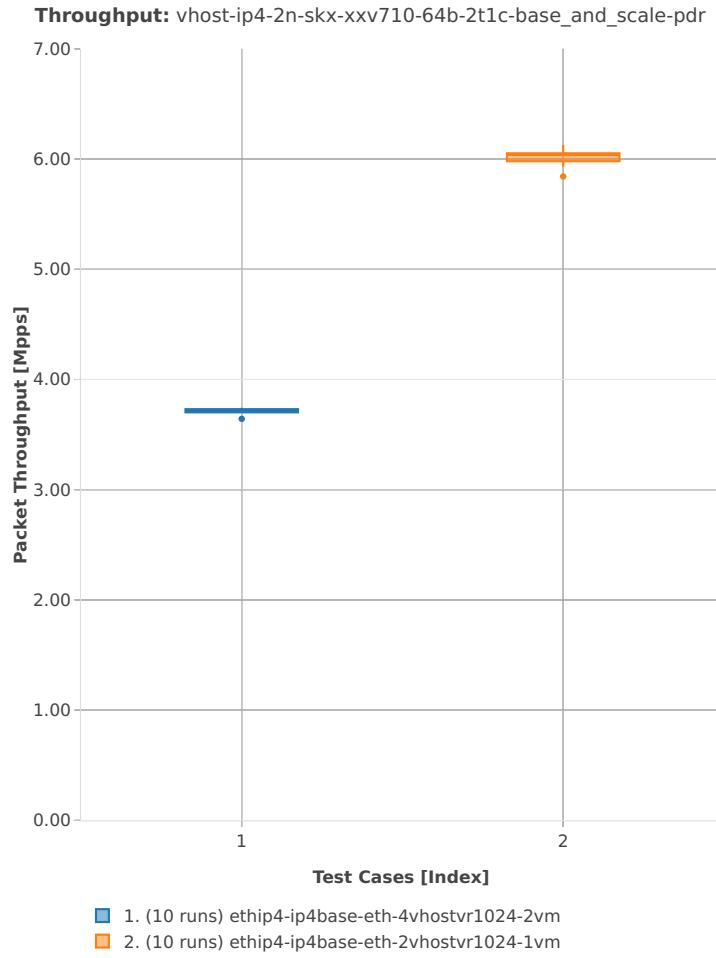



64b-4t2c-base\_and\_scale-ip4

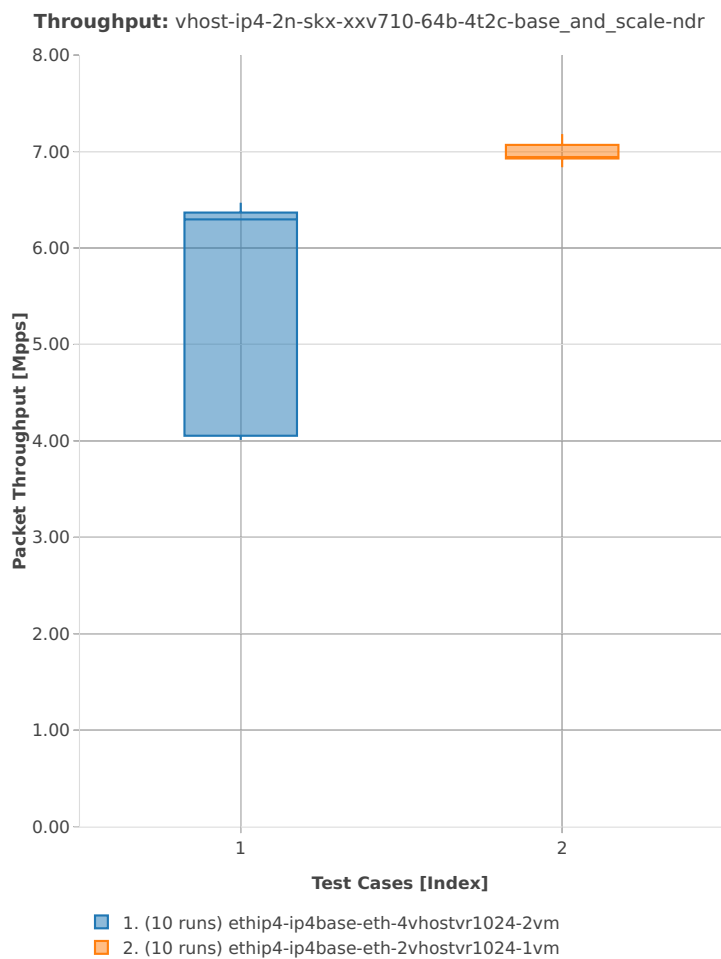

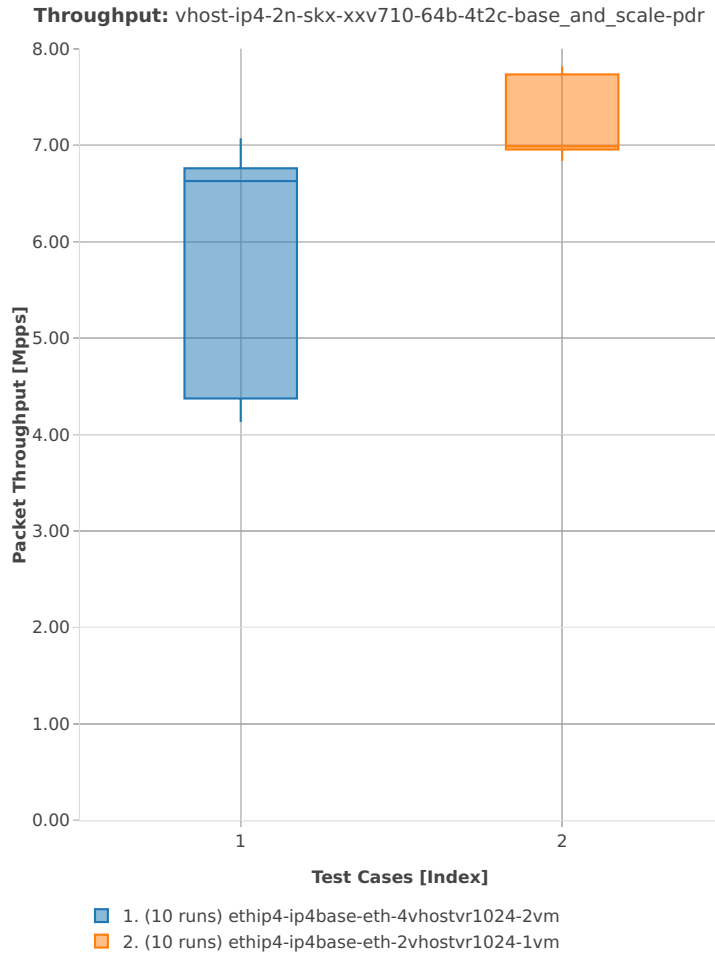

### 2.3.8 LXC/DRC Container Memif

Following sections include summary graphs of VPP Phy-to-Phy performance with Container memif Connections, including NDR throughput (zero packet loss) and PDR throughput (<0.5% packet loss). Performance is reported for VPP running in multiple configurations of VPP worker thread(s), a.k.a. VPP data plane thread(s), and their physical CPU core(s) placement.

CSIT source code for the test cases used for plots can be found in [CSIT git repository](#)<sup>49</sup>.

---

<sup>49</sup> [https://git.fd.io/csit/tree/tests/vpp/perf/container\\_memif?h=rls1901](https://git.fd.io/csit/tree/tests/vpp/perf/container_memif?h=rls1901)

## 3n-hsw-x520

## 64b-1t1c-base\_and\_scale

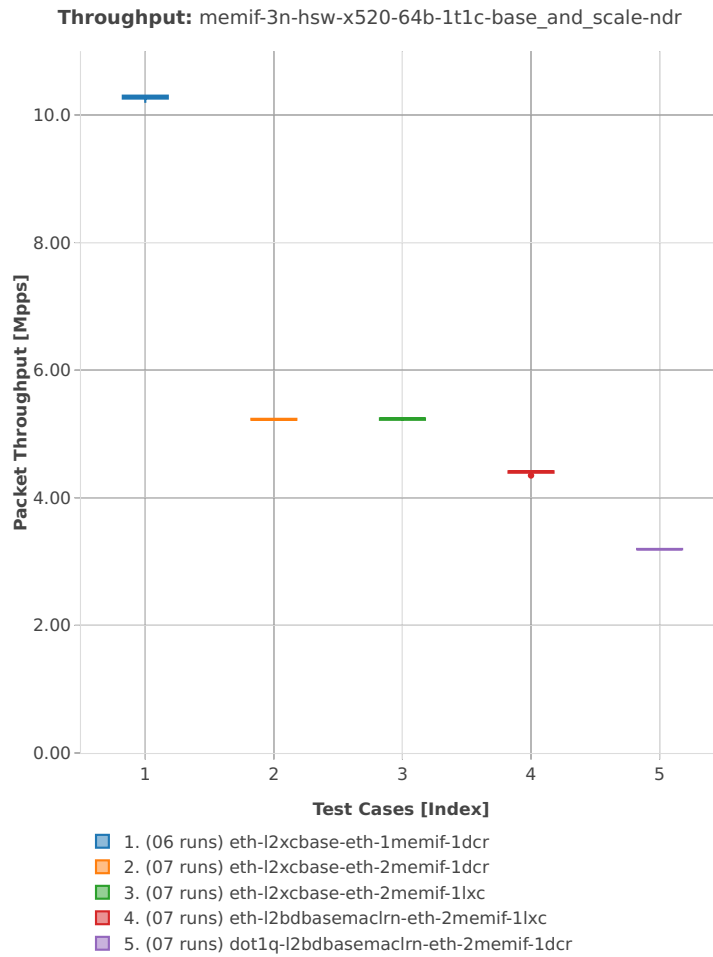

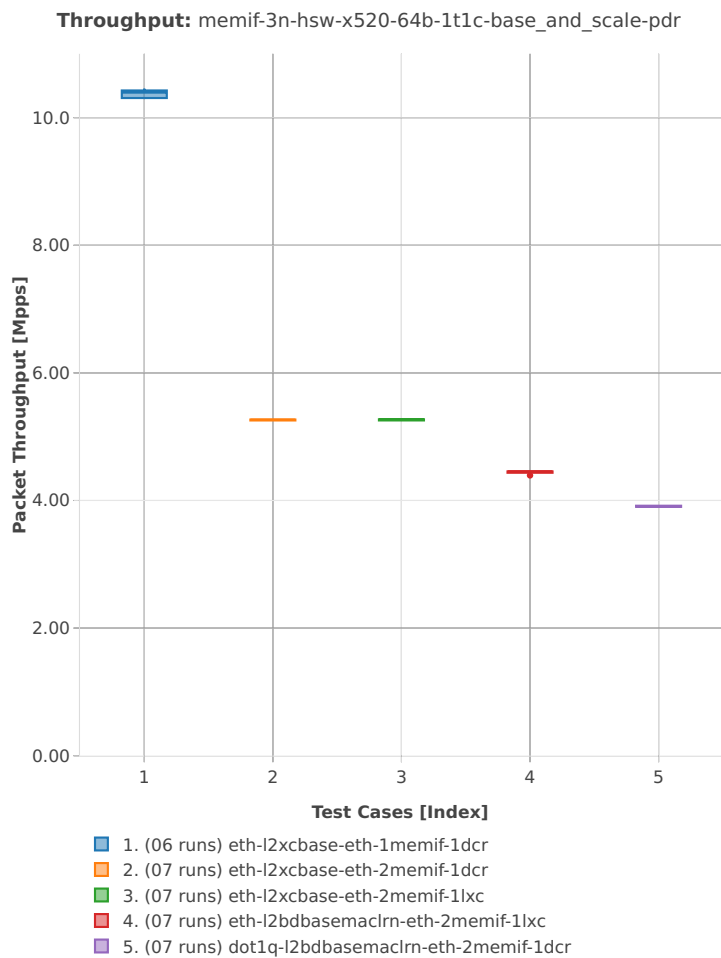

64b-2t2c-base\_and\_scale

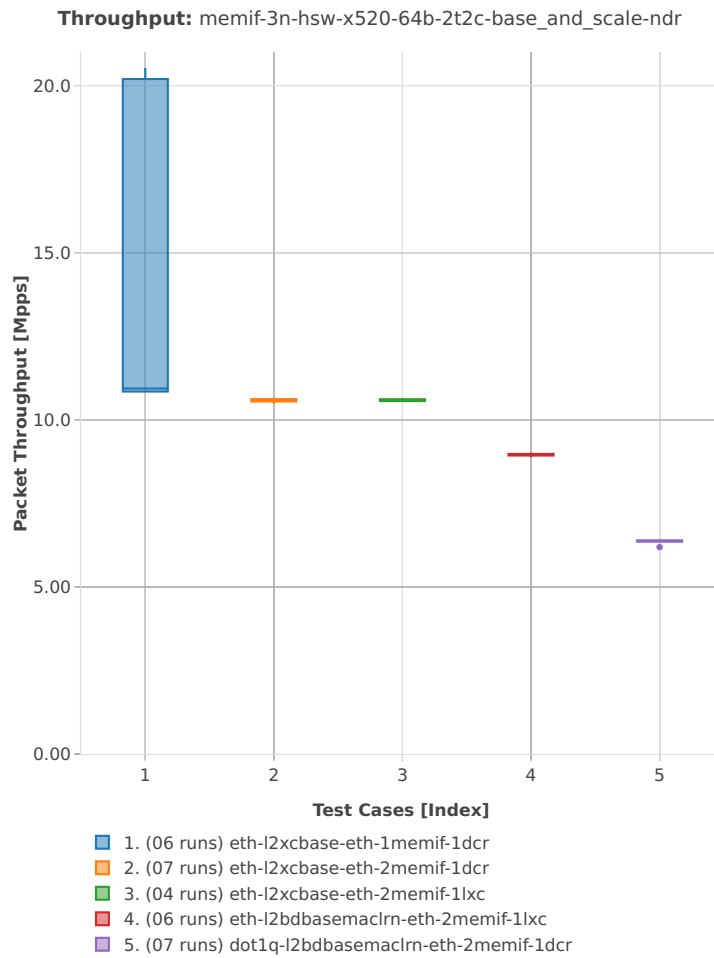

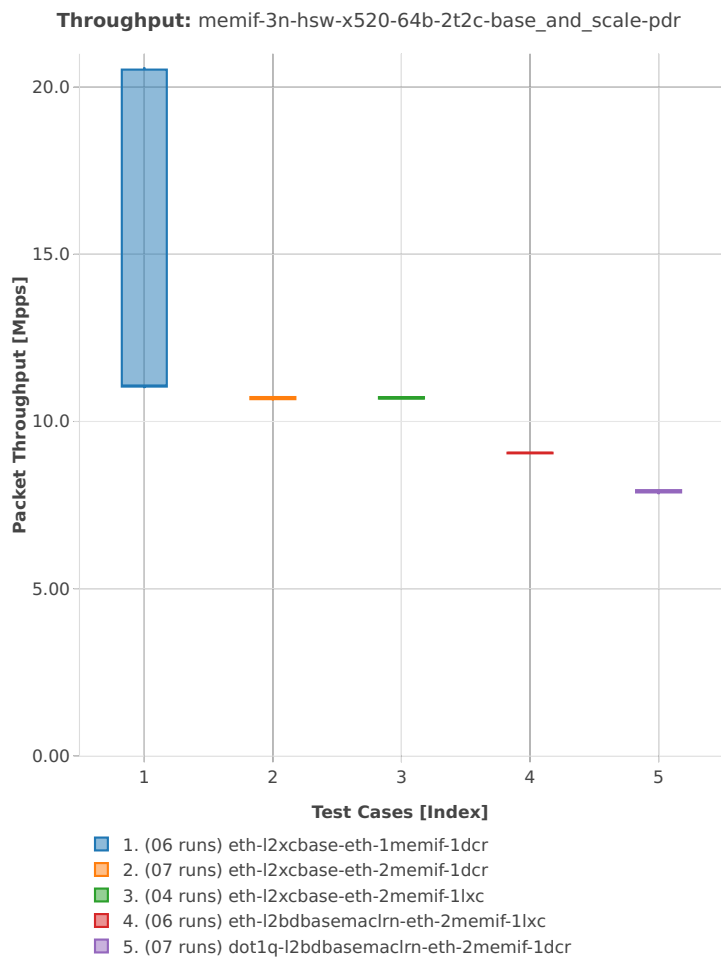

3n-hsw-x710

64b-1t1c-base\_and\_scale

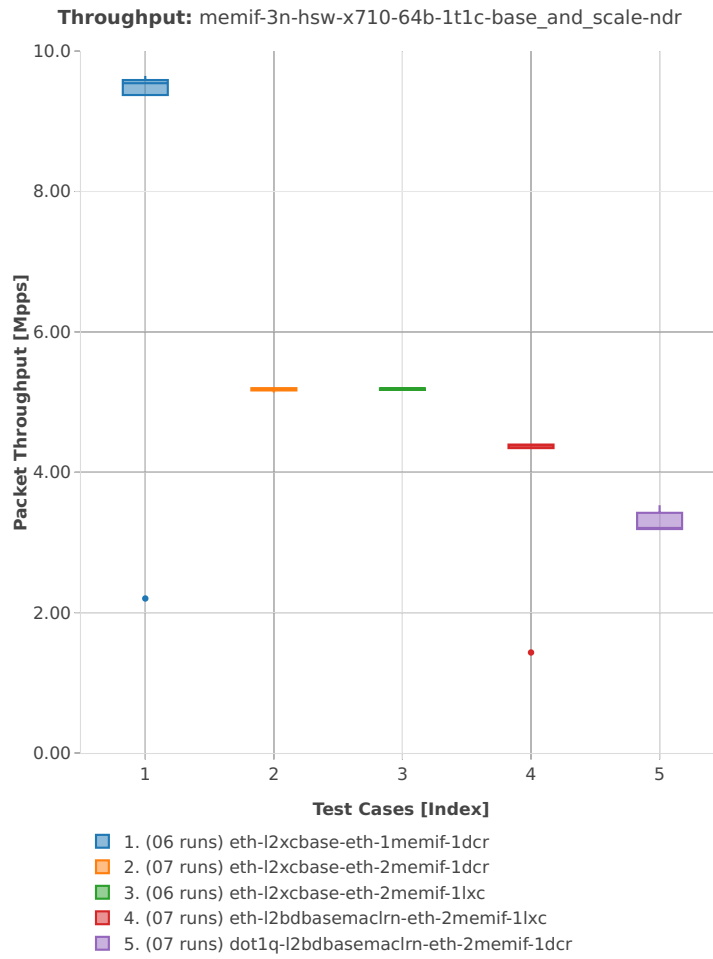



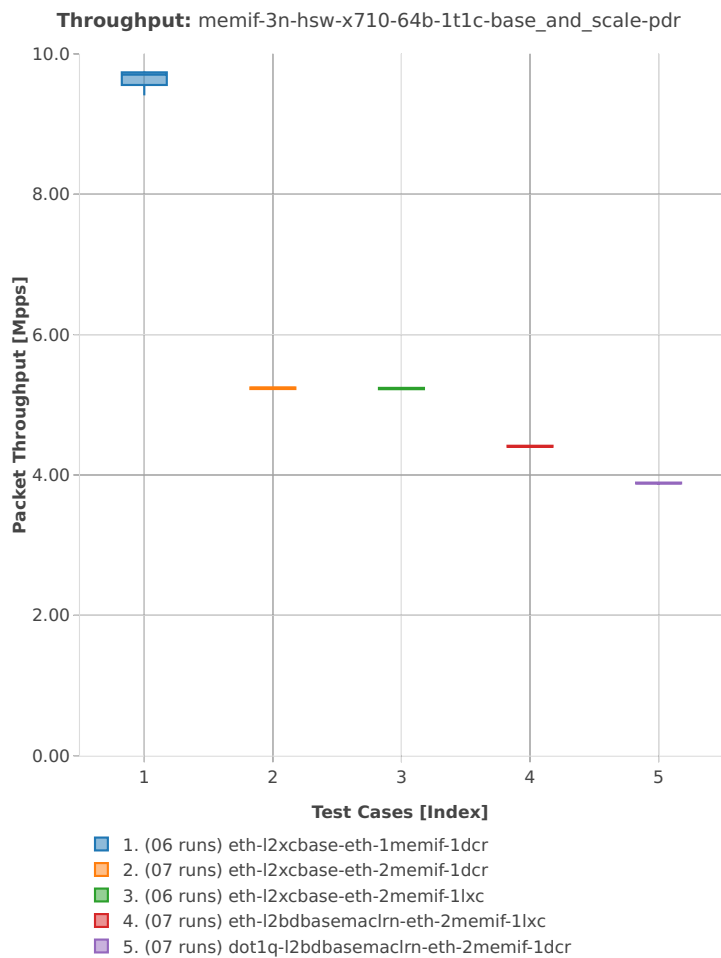

64b-2t2c-base\_and\_scale

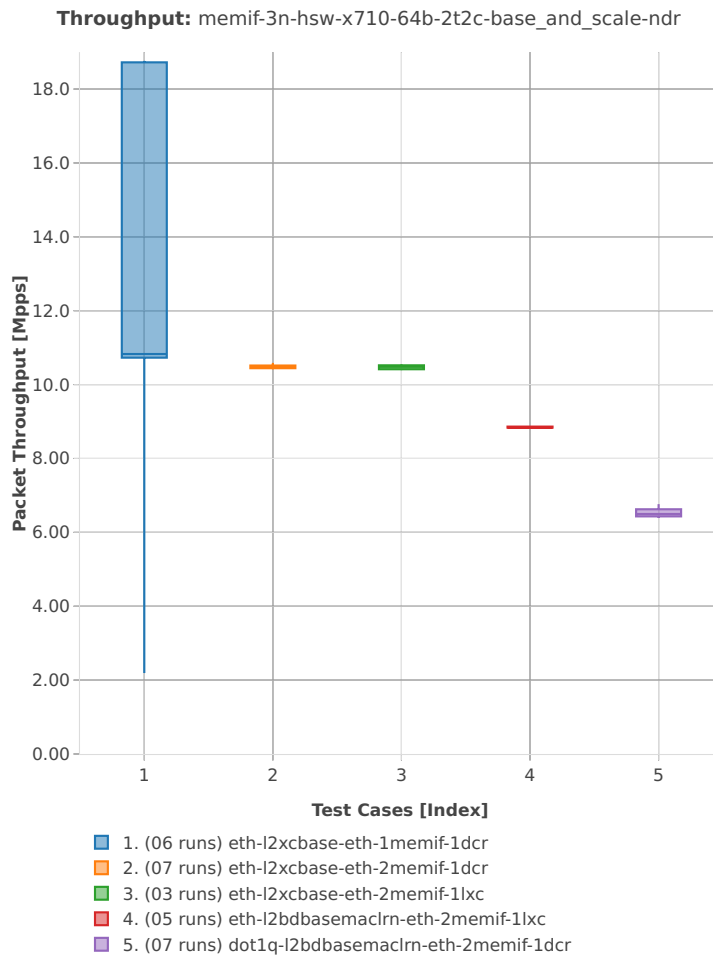

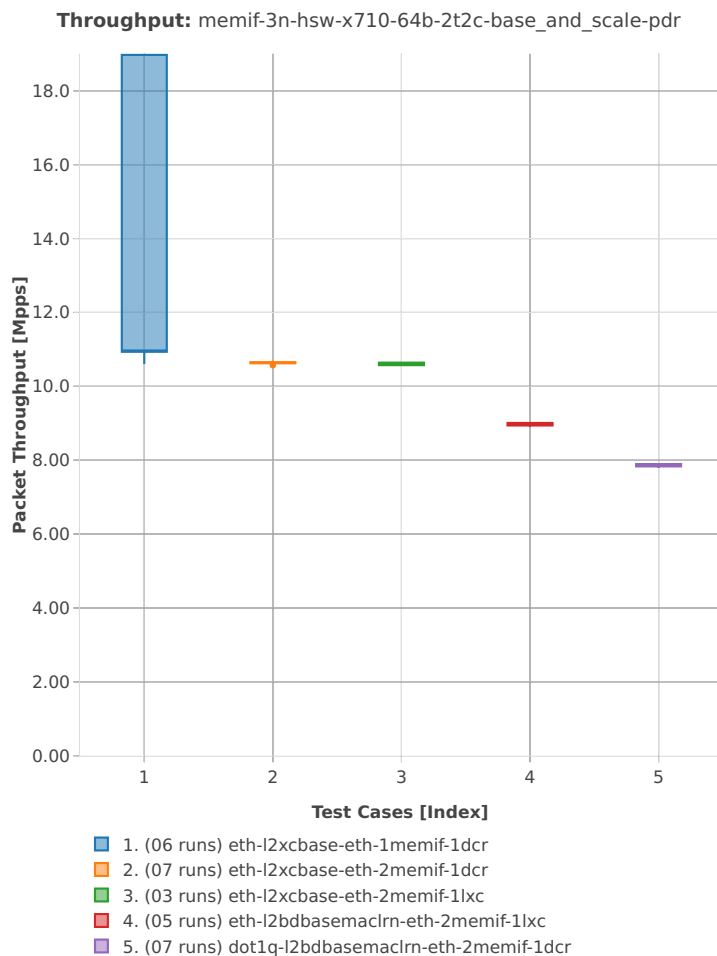

3n-hsw-xl710

64b-1t1c-base\_and\_scale

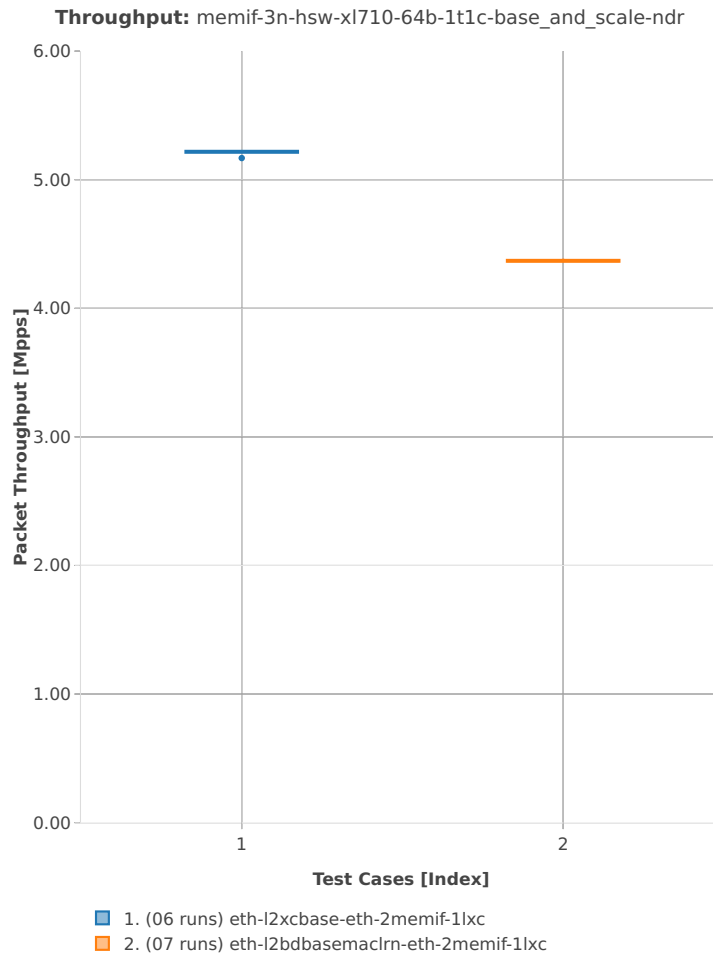

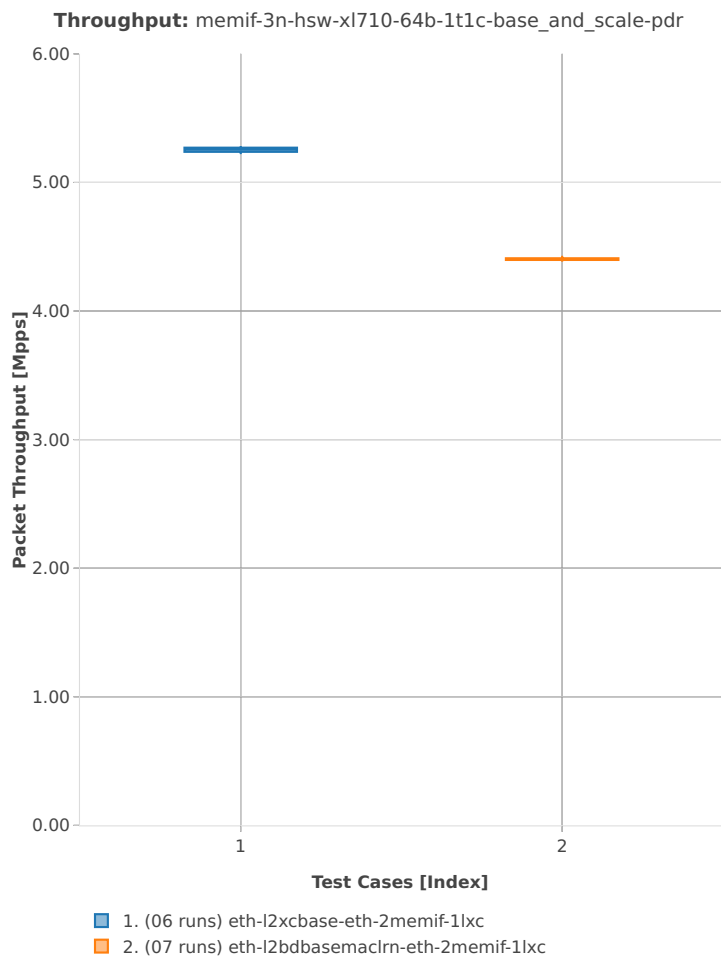

64b-2t2c-base\_and\_scale

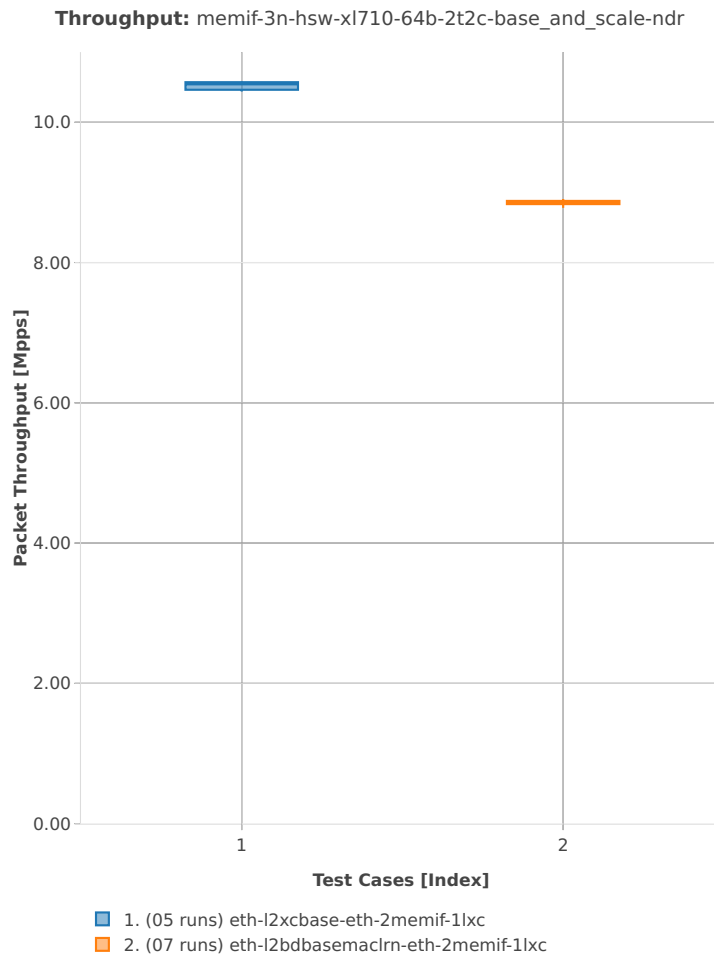

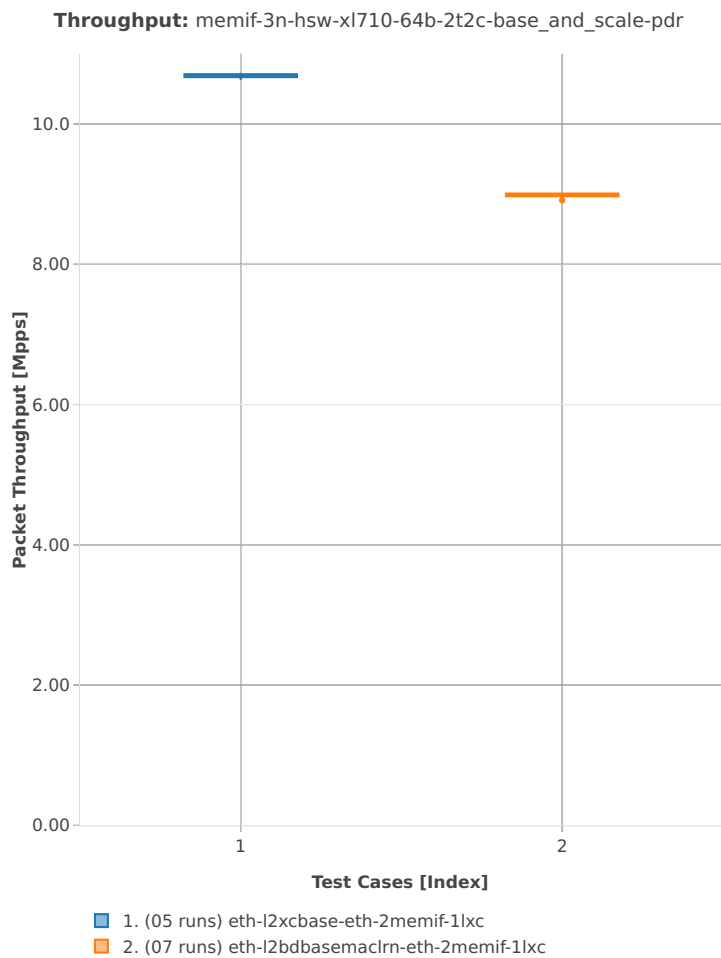

3n-skx-x710

64b-2t1c-base\_and\_scale

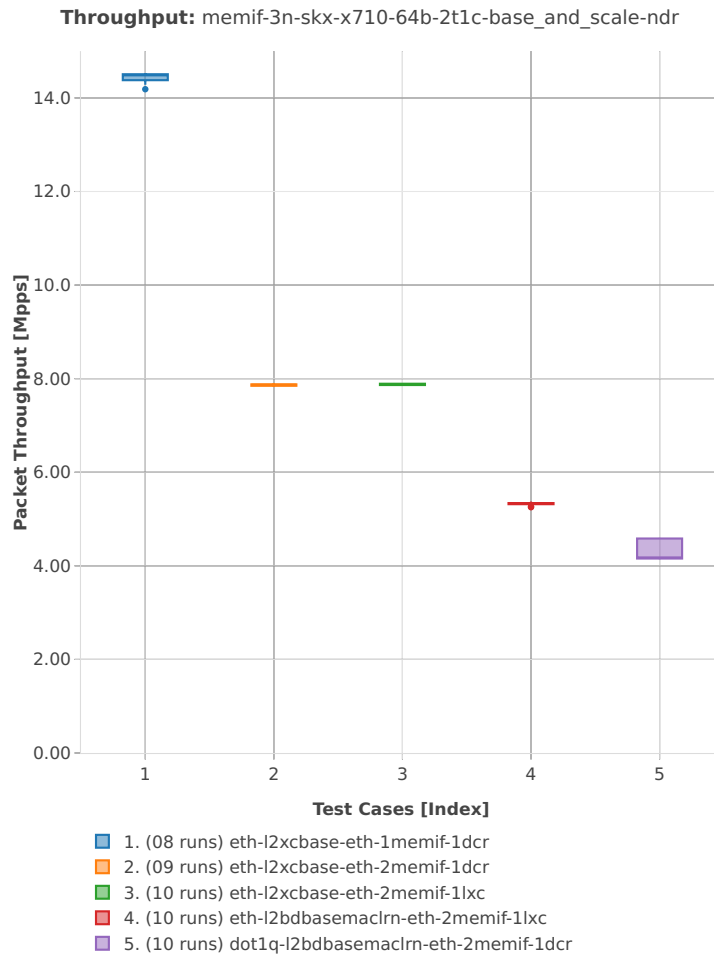



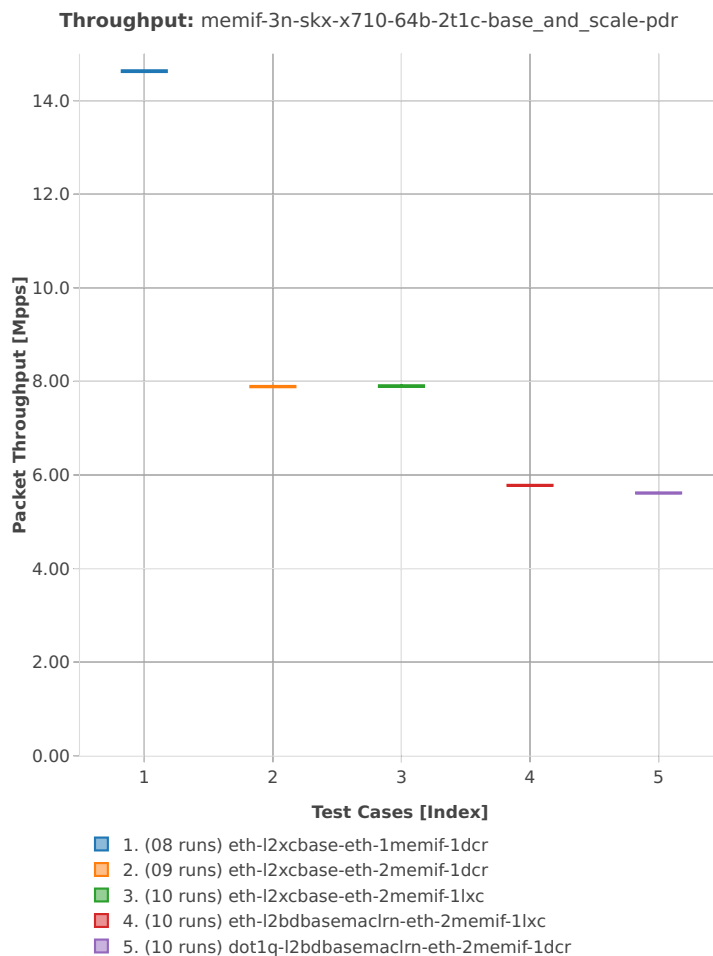

64b-4t2c-base\_and\_scale

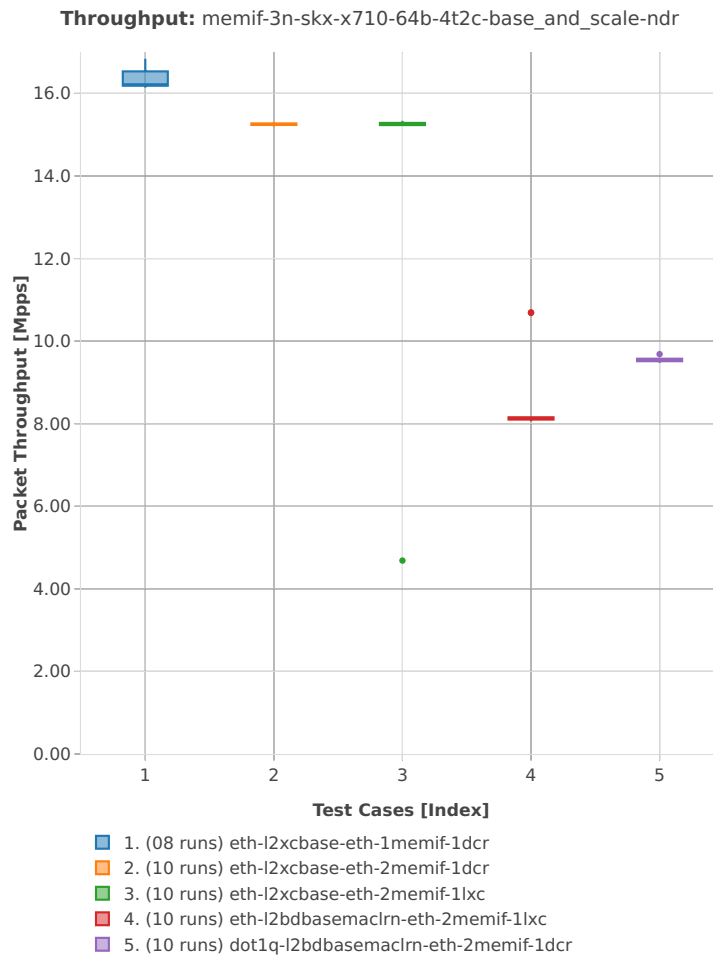

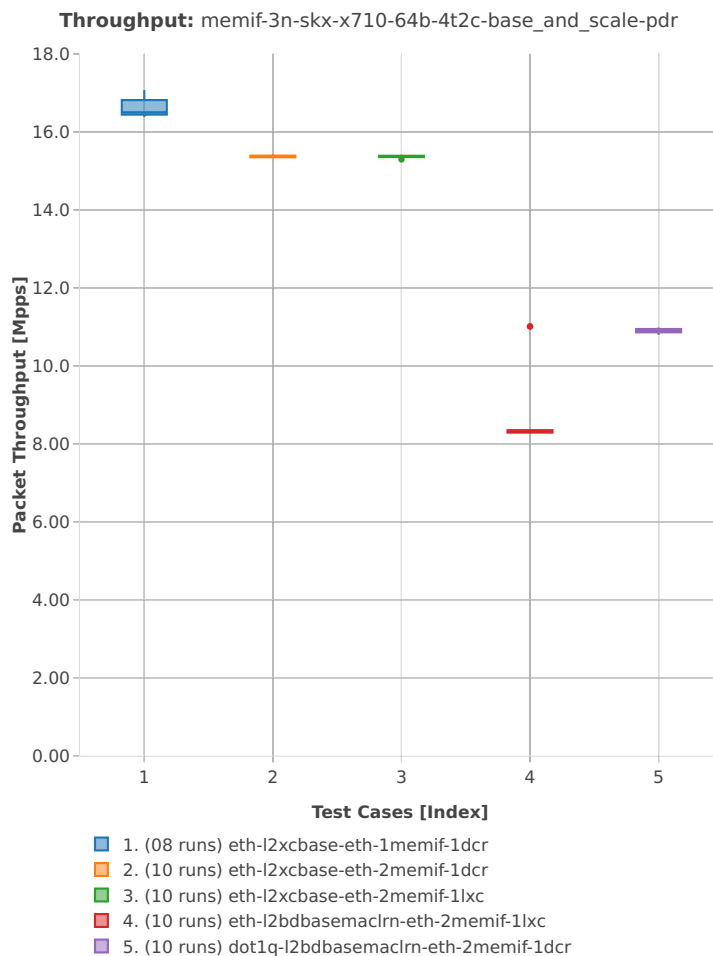

## 2n-skx-x710

## 64b-2t1c-base\_and\_scale

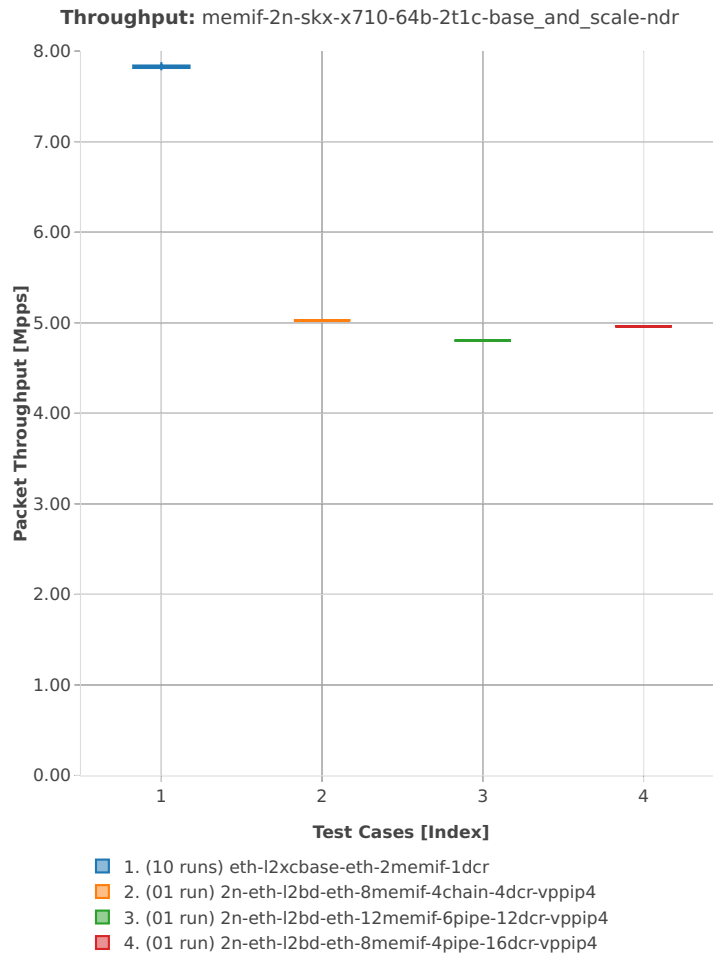

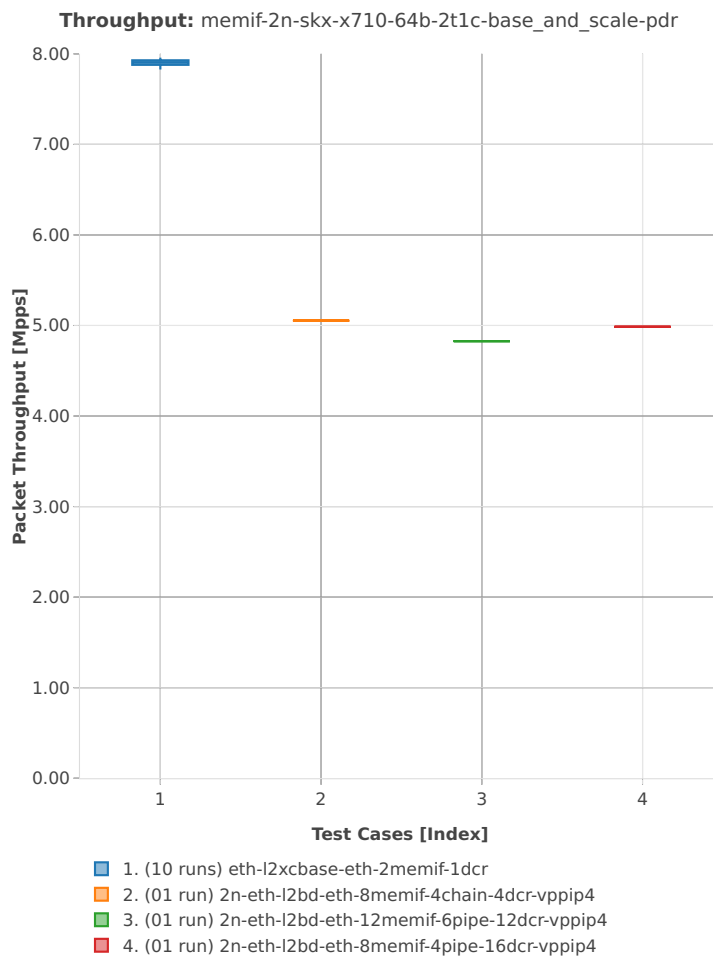

64b-4t2c-base\_and\_scale

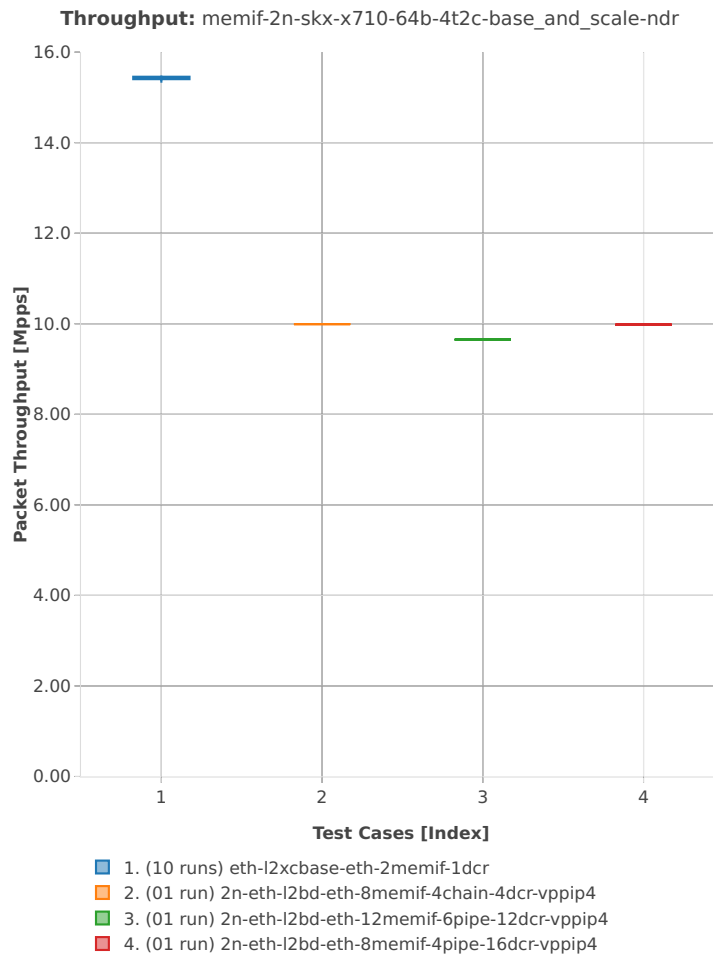

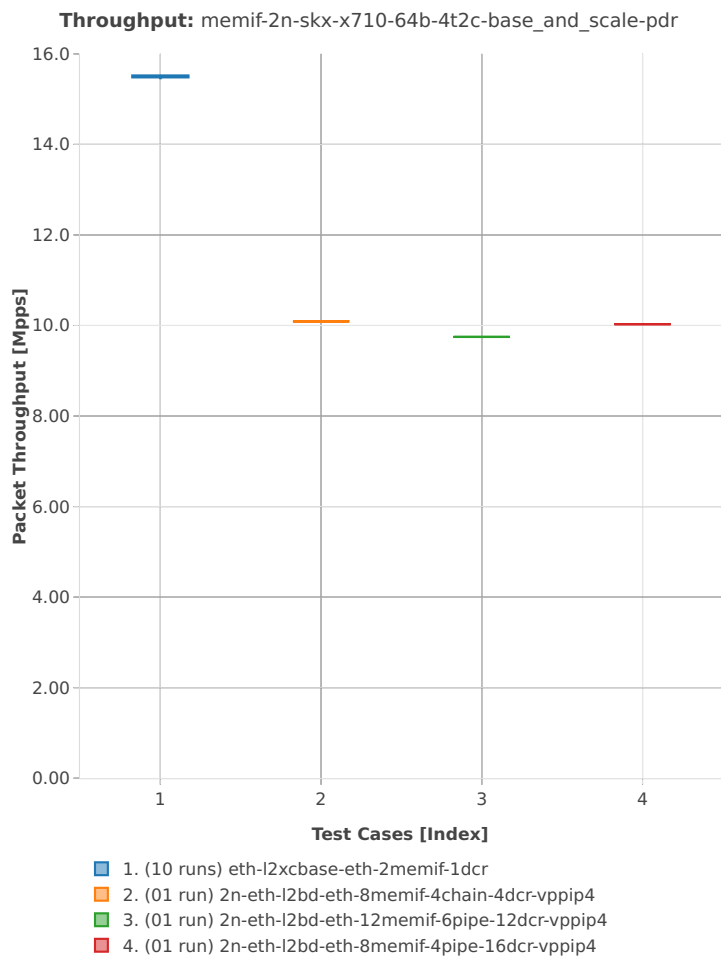

2n-skx-xxv710

64b-2t1c-base\_and\_scale

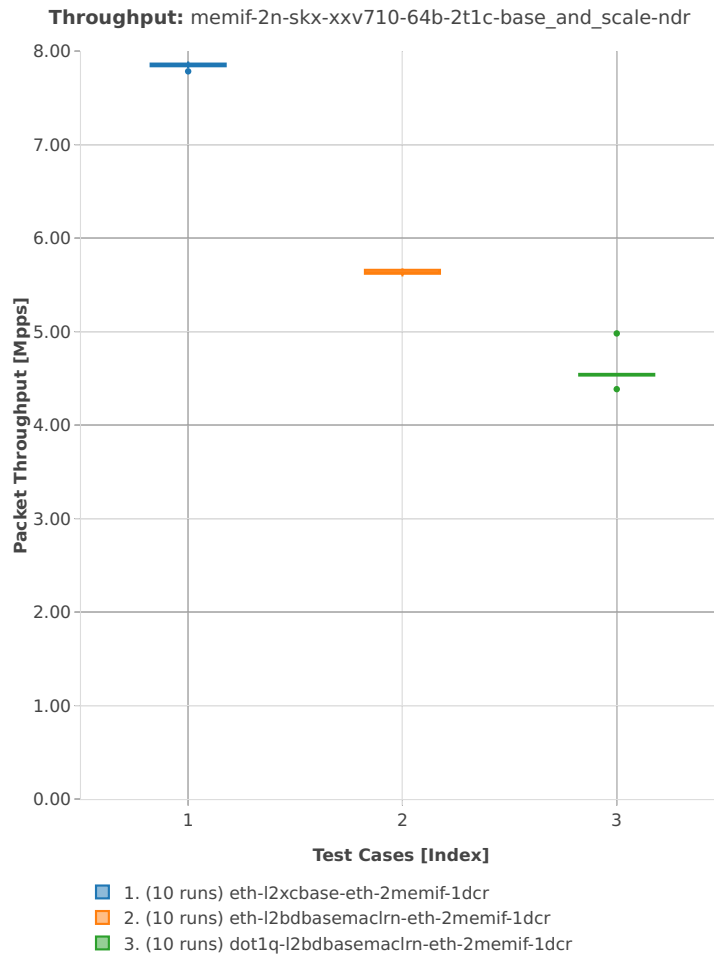



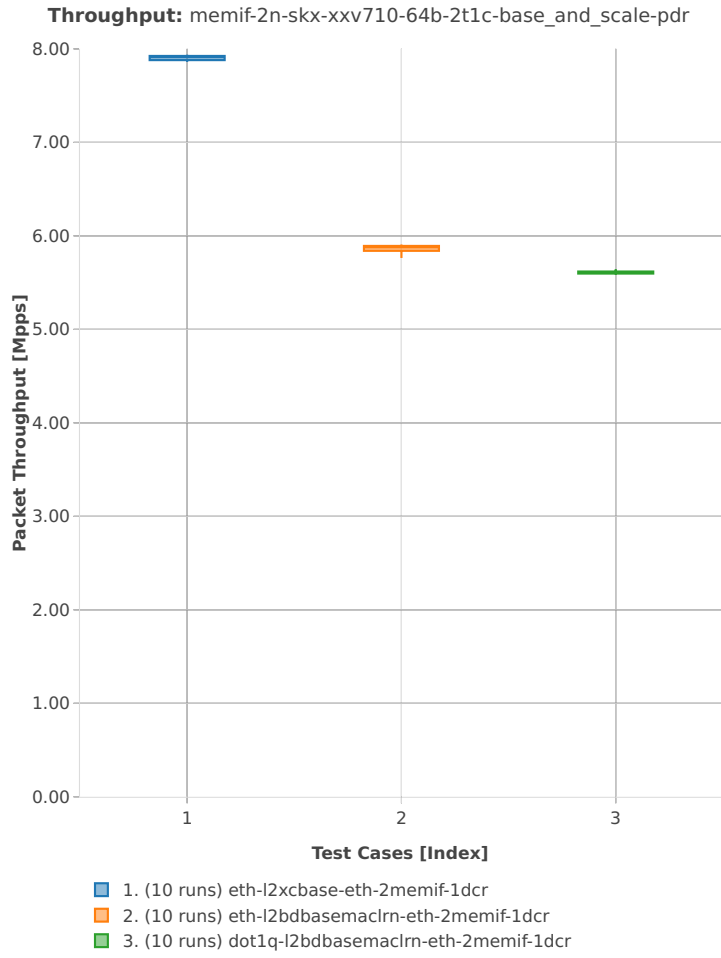

64b-4t2c-base\_and\_scale

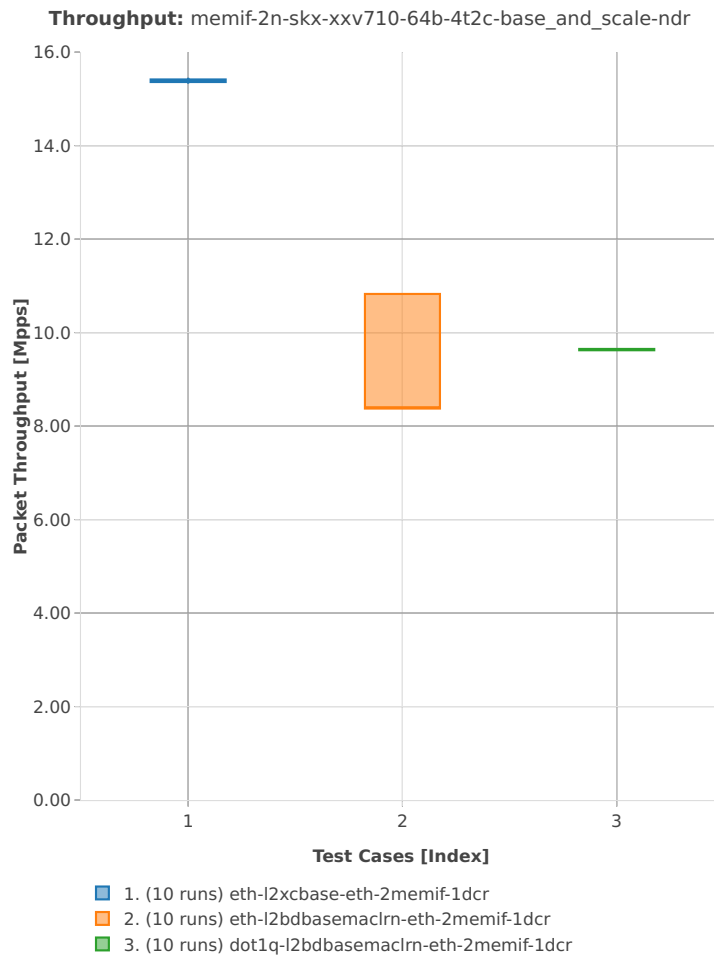

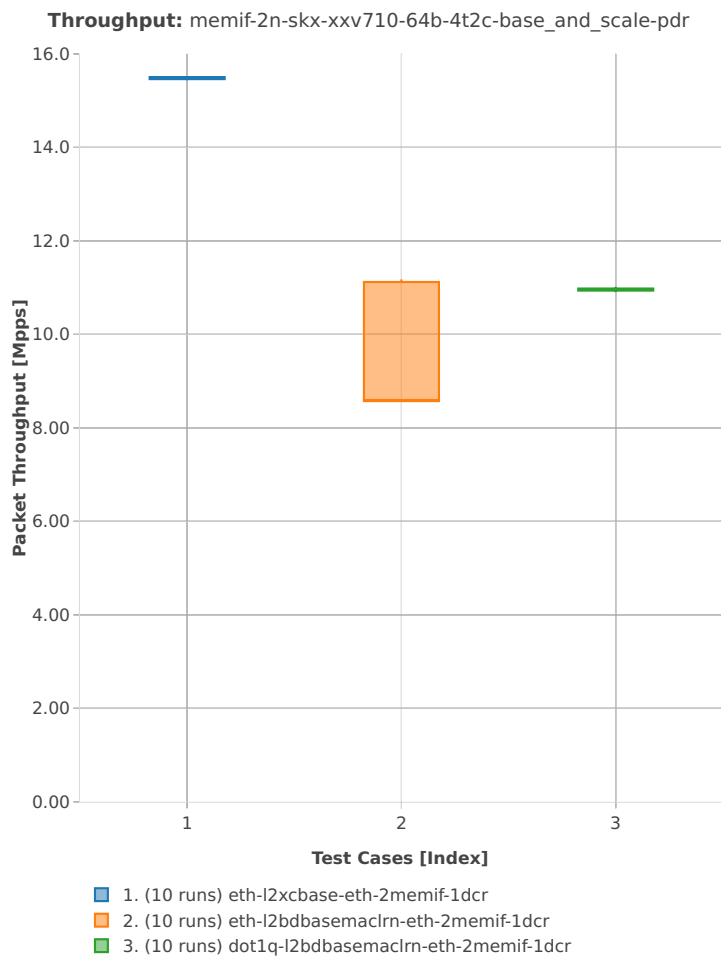

### 2.3.9 IPsec IPv4 Routing

Following sections include summary graphs of VPP Phy-to-Phy performance with IPsec encryption used in combination with IPv4 routed-forwarding, including NDR throughput (zero packet loss) and PDR throughput (<0.5% packet loss). VPP IPsec encryption is accelerated using DPDK cryptodev library driving Intel Quick Assist (QAT) crypto PCIe hardware cards. Performance is reported for VPP running in multiple configurations of VPP worker thread(s), a.k.a. VPP data plane thread(s), and their physical CPU core(s) placement.

CSIT source code for the test cases used for plots can be found in [CSIT git repository](#)<sup>50</sup>.

---

<sup>50</sup> <https://git.fd.io/csit/tree/tests/vpp/perf/crypto?h=rls1901>

3n-hsw-xl710

64b-1t1c-base

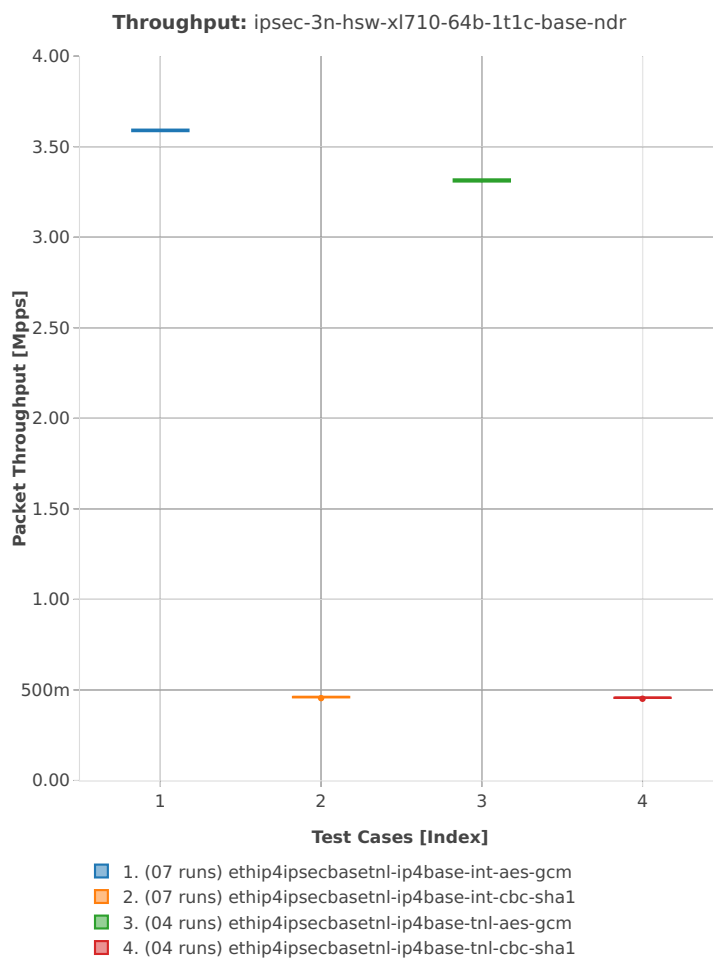

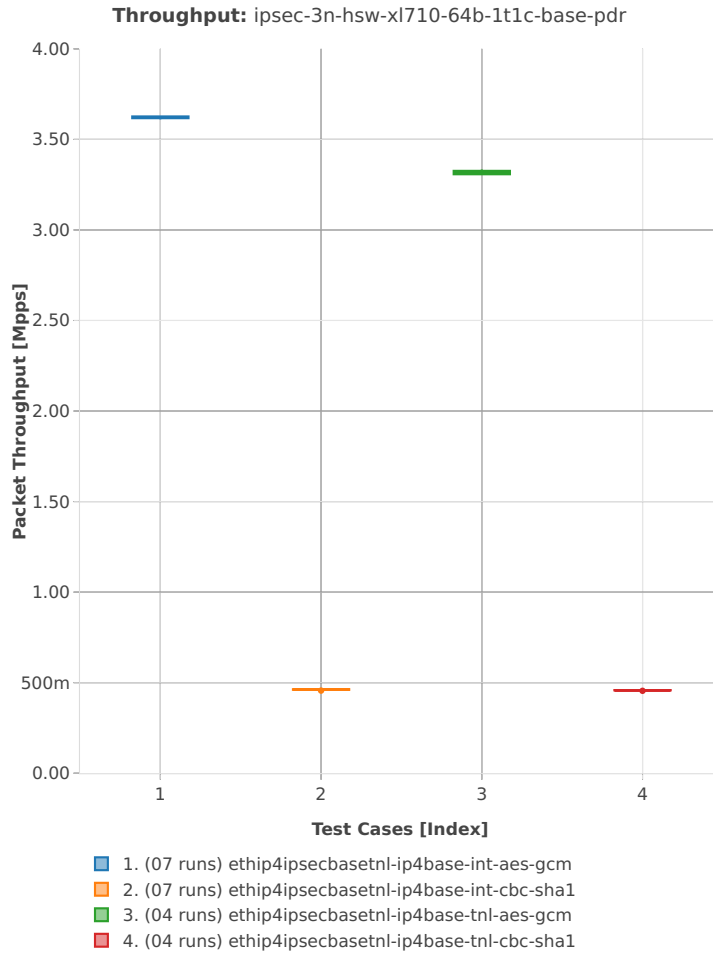

64b-2t2c-base

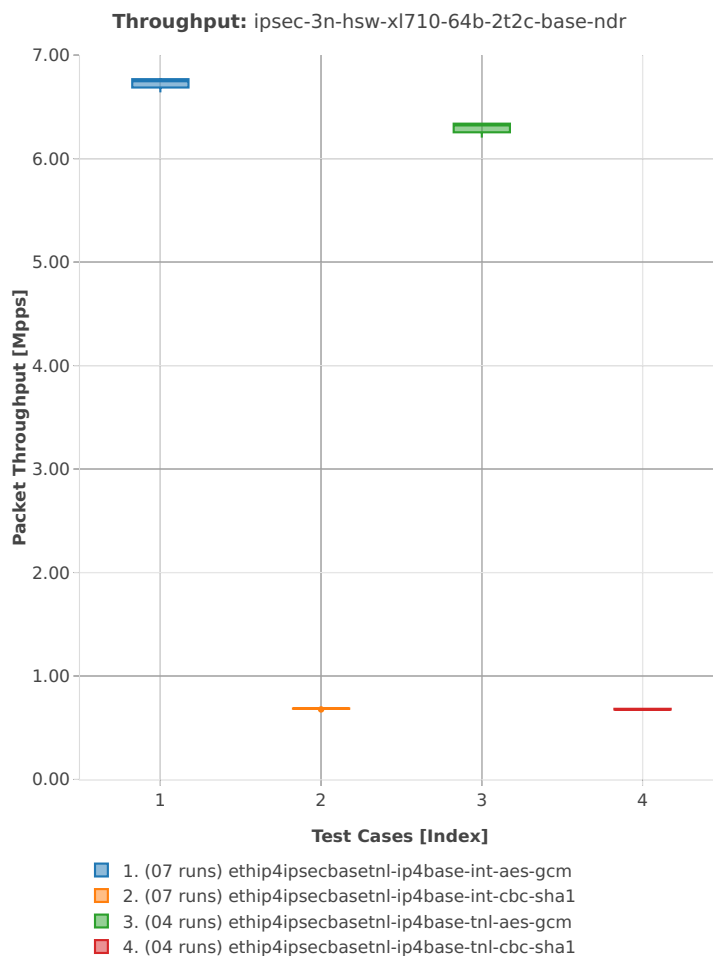

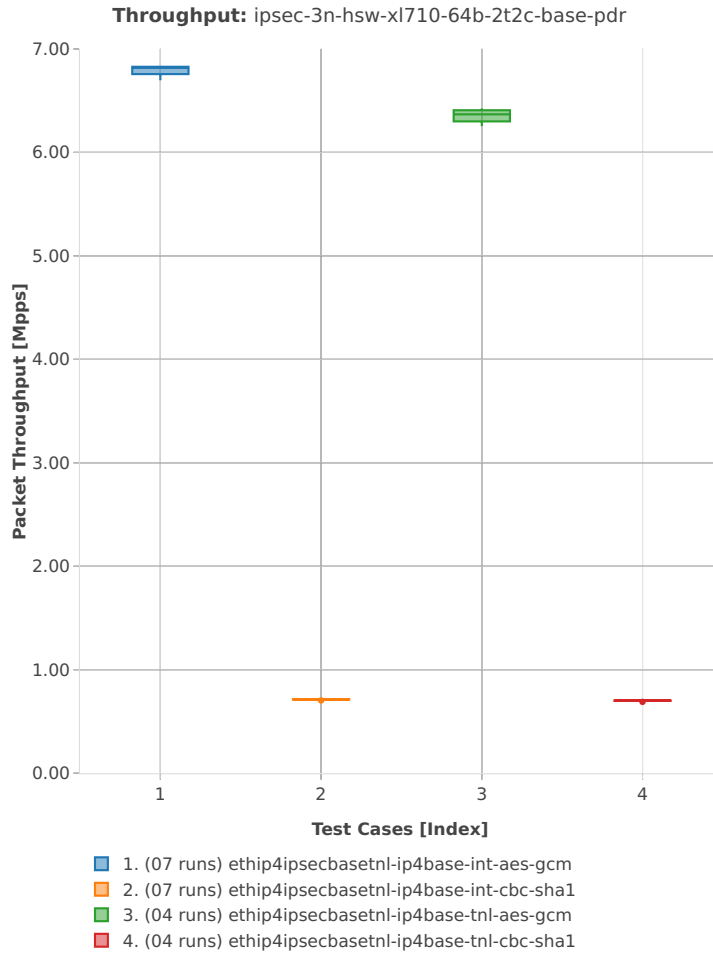



64b-1t1c-scale

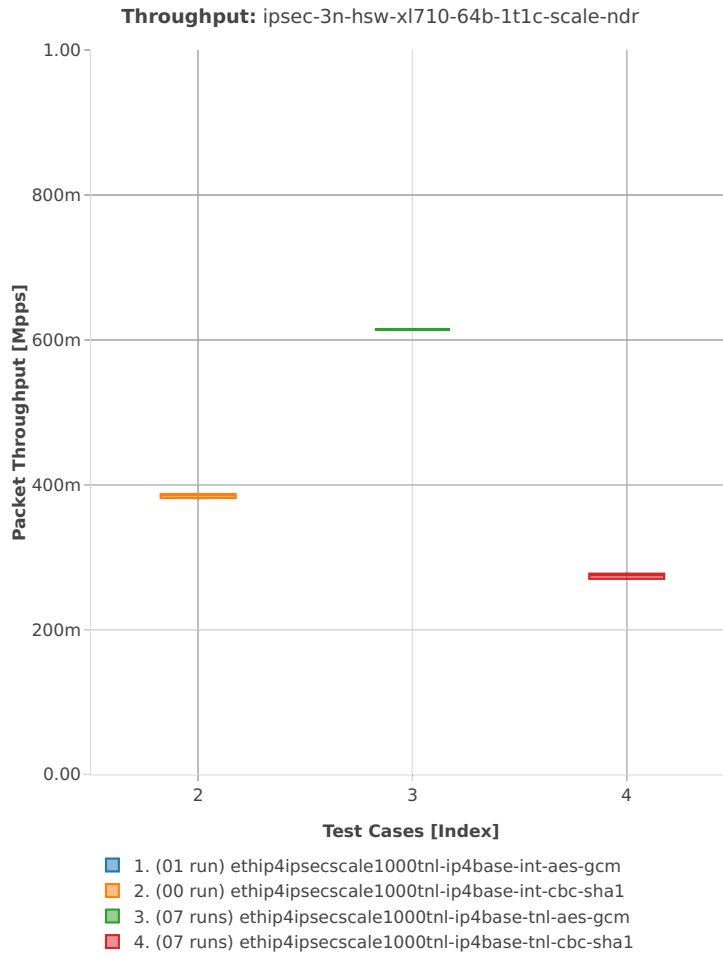

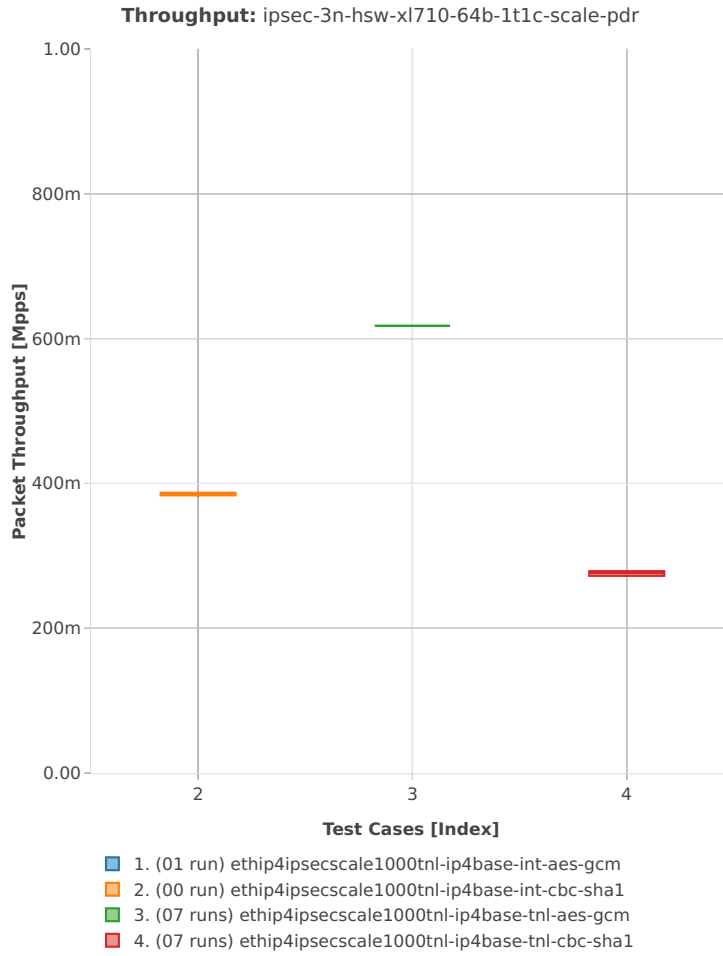

64b-2t2c-scale

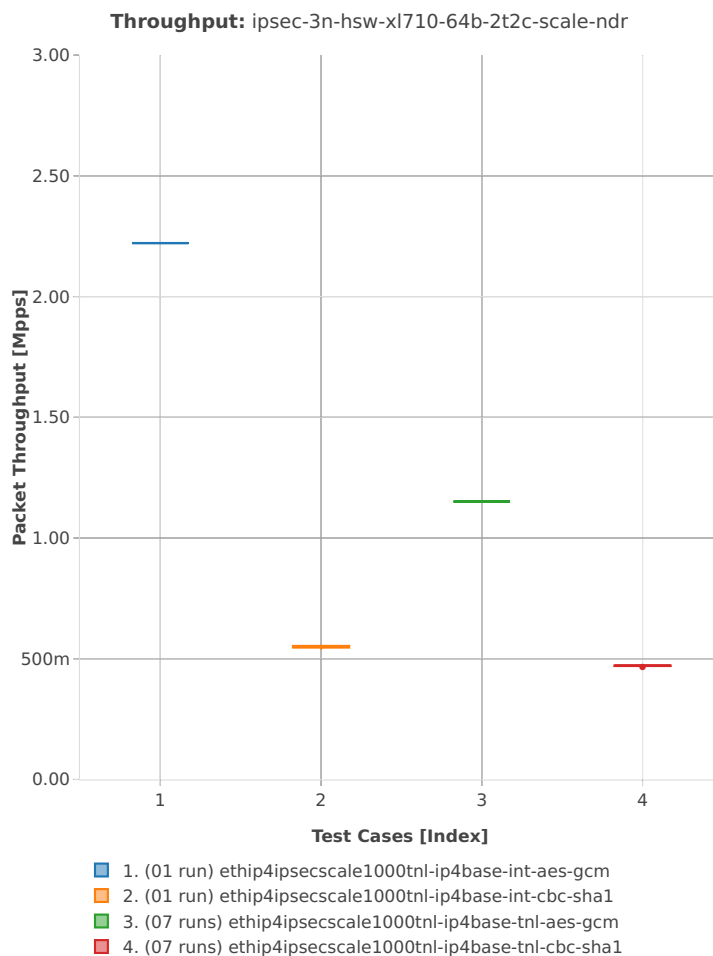

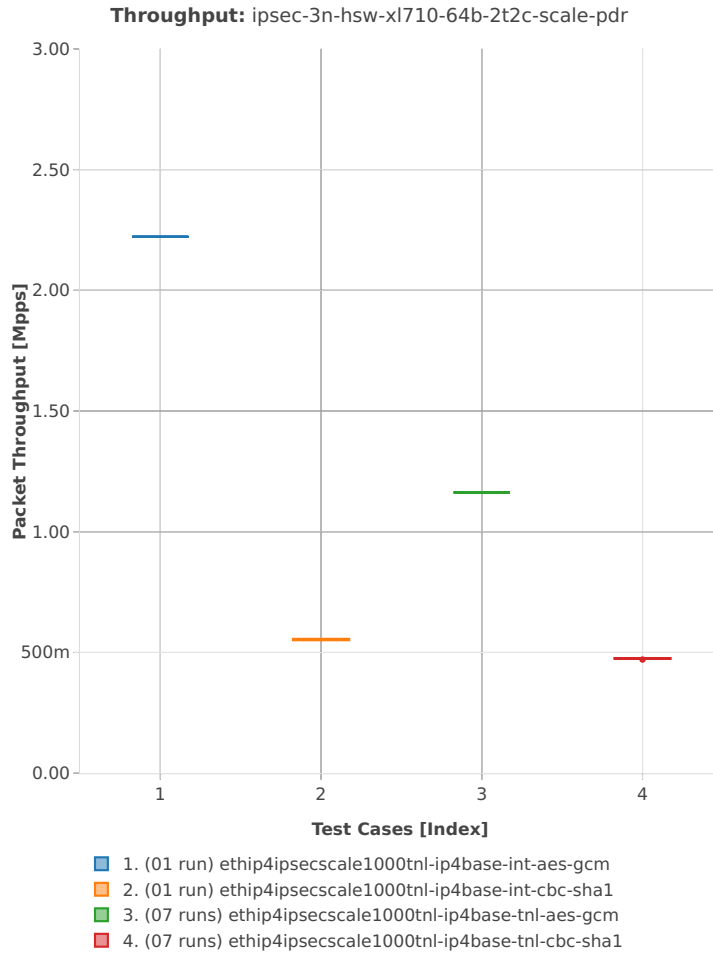

64b-1t1c-sw

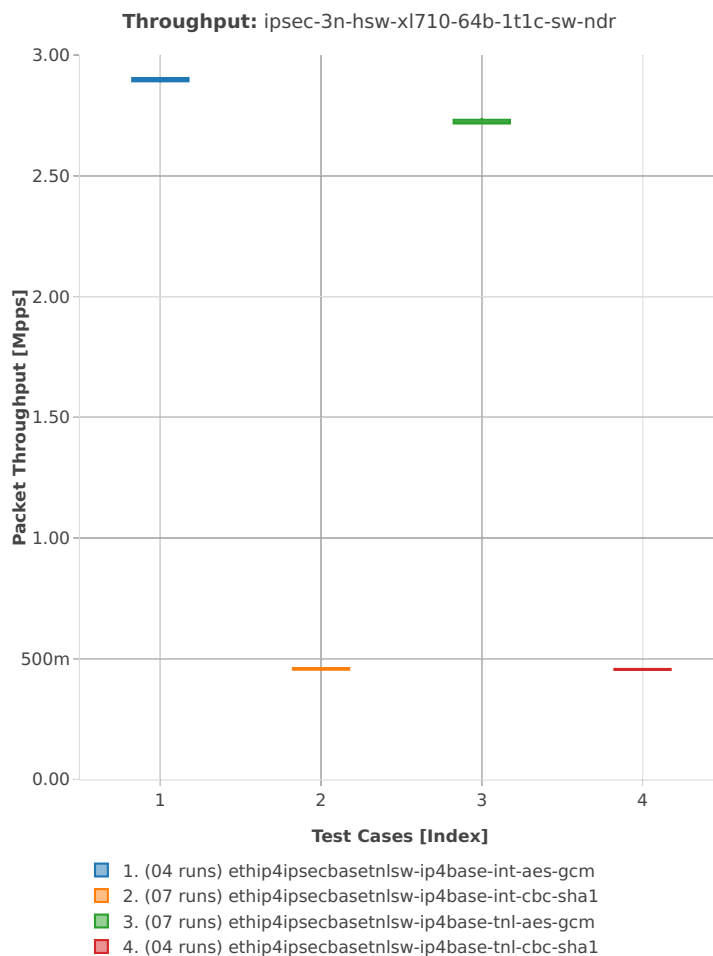

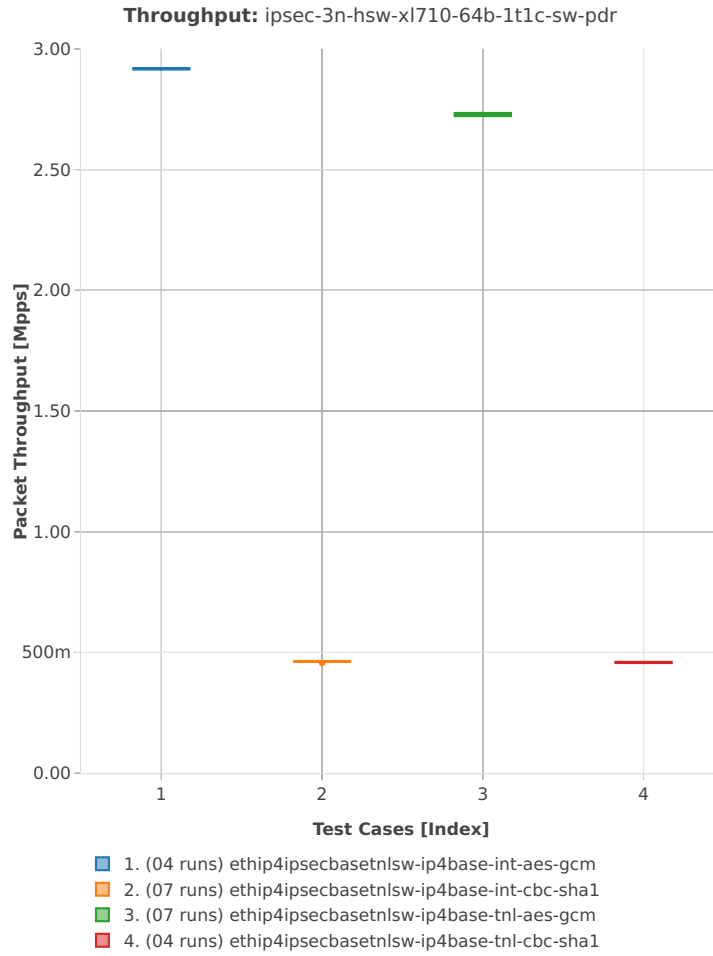

64b-2t2c-sw

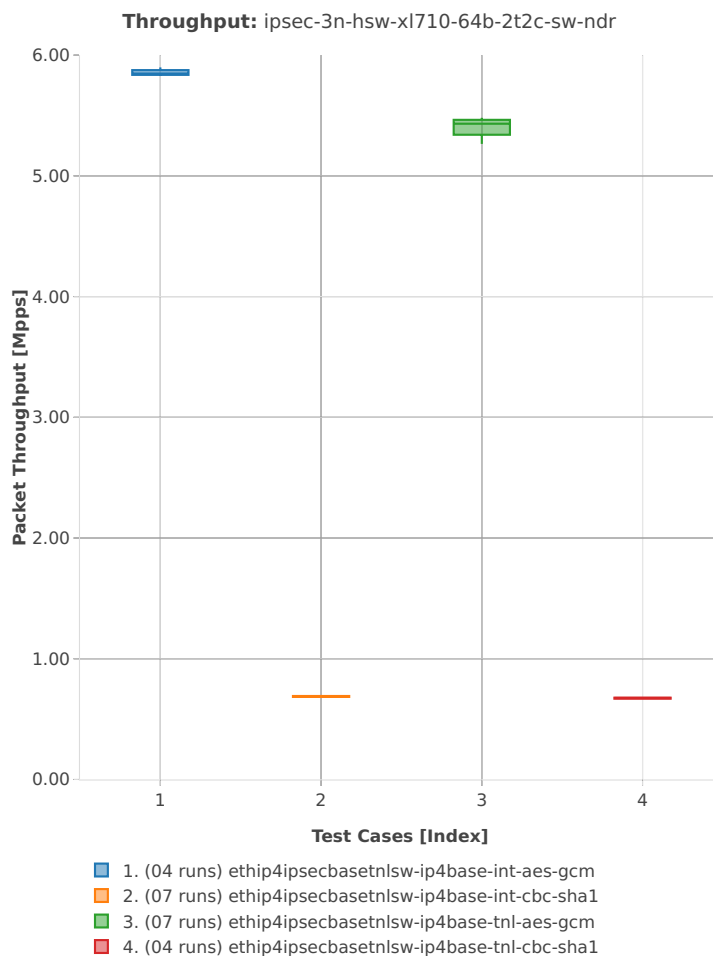

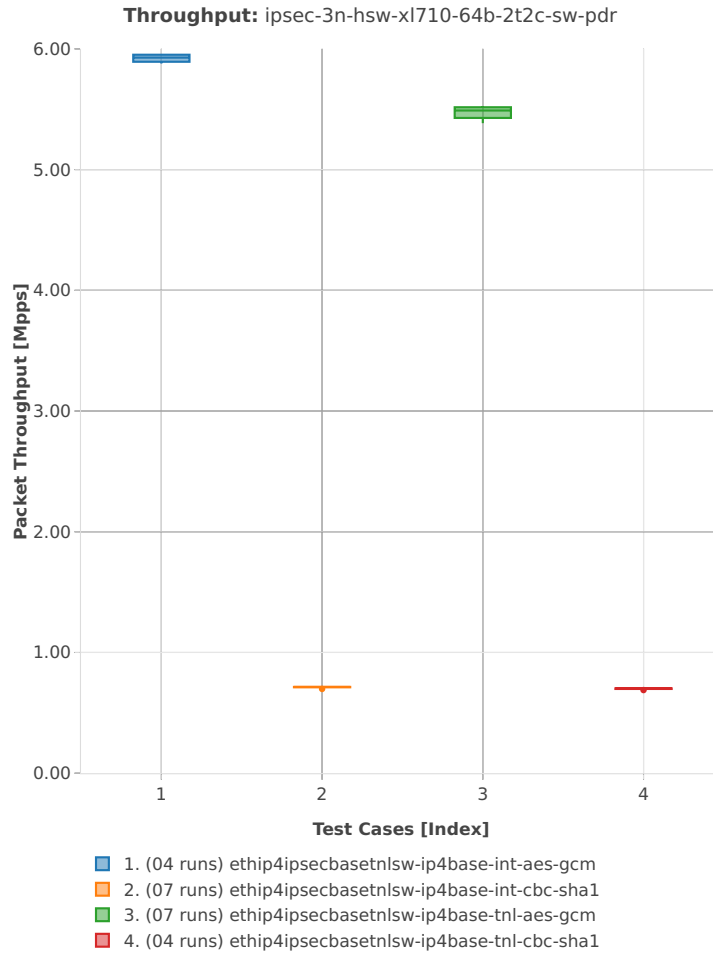



### 2.3.10 VTS

Following sections include summary graphs of VPP Phy-to-VM(s)-to-Phy performance with VM virtio and VPP vhost-user virtual interfaces, including NDR throughput (zero packet loss) and PDR throughput (<0.5% packet loss). Performance is reported for VPP running in multiple configurations of VPP worker thread(s), a.k.a. VPP data plane thread(s), and their physical CPU core(s) placement.

CSIT source code for the test cases used for plots can be found in [CSIT git repository](#)<sup>51</sup>.

---

<sup>51</sup> <https://git.fd.io/csit/tree/tests/vpp/perf/vts?h=rls1901>

3n-hsw-x520

114b-1t1c

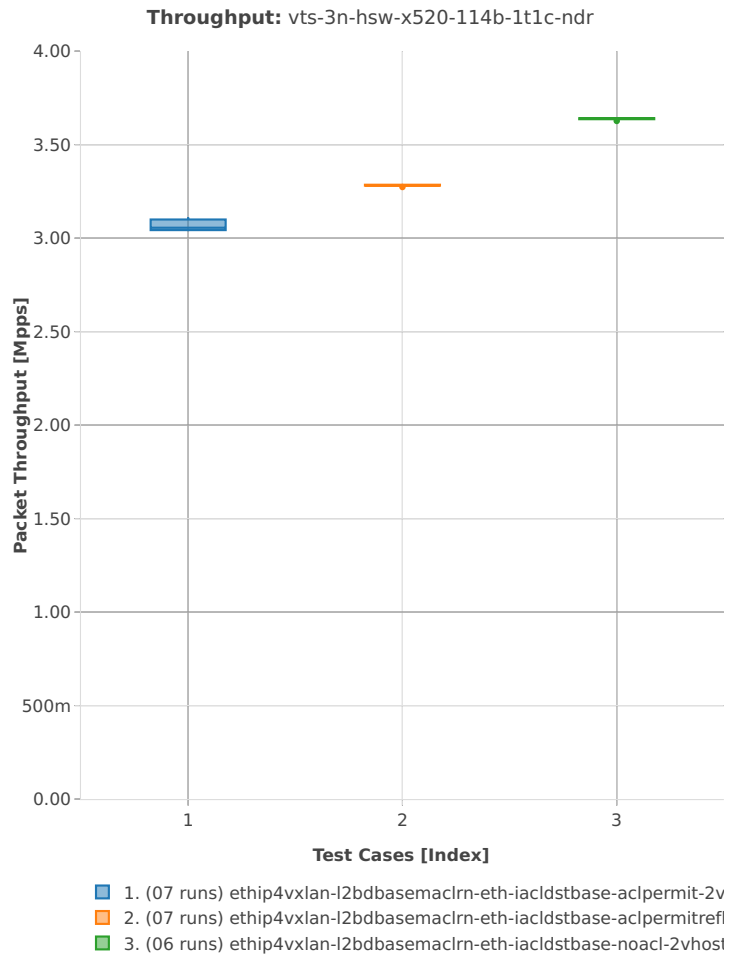

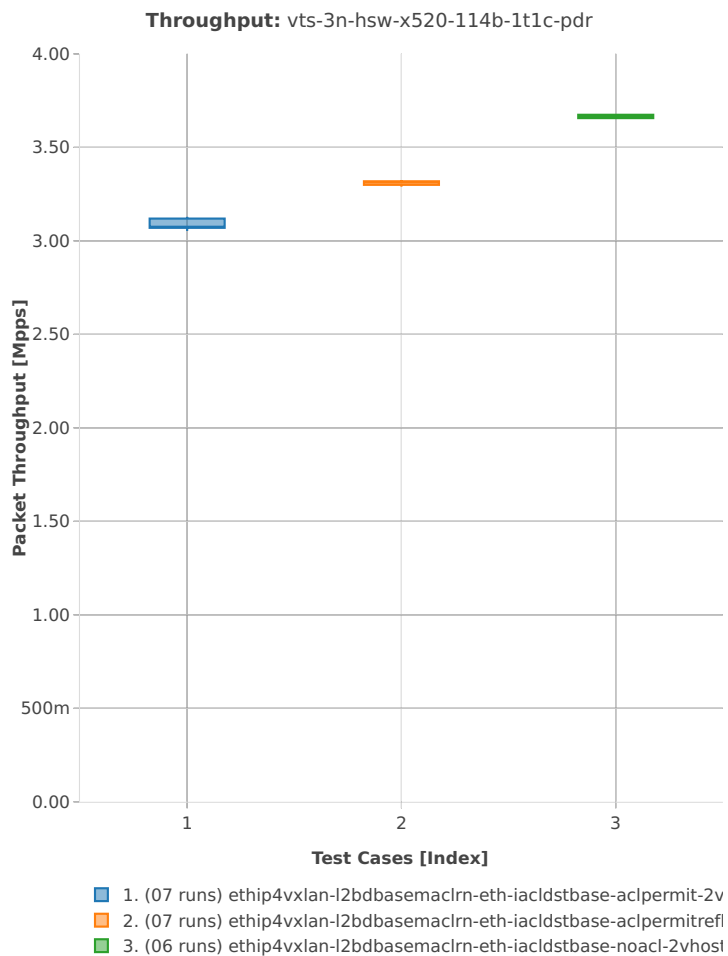

114b-2t2c

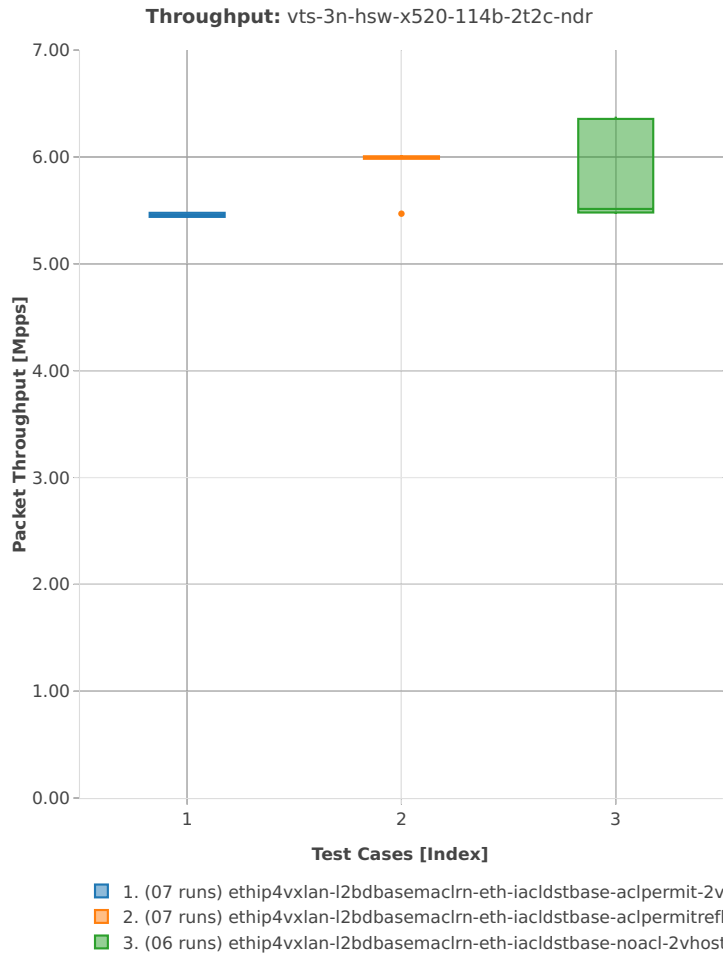

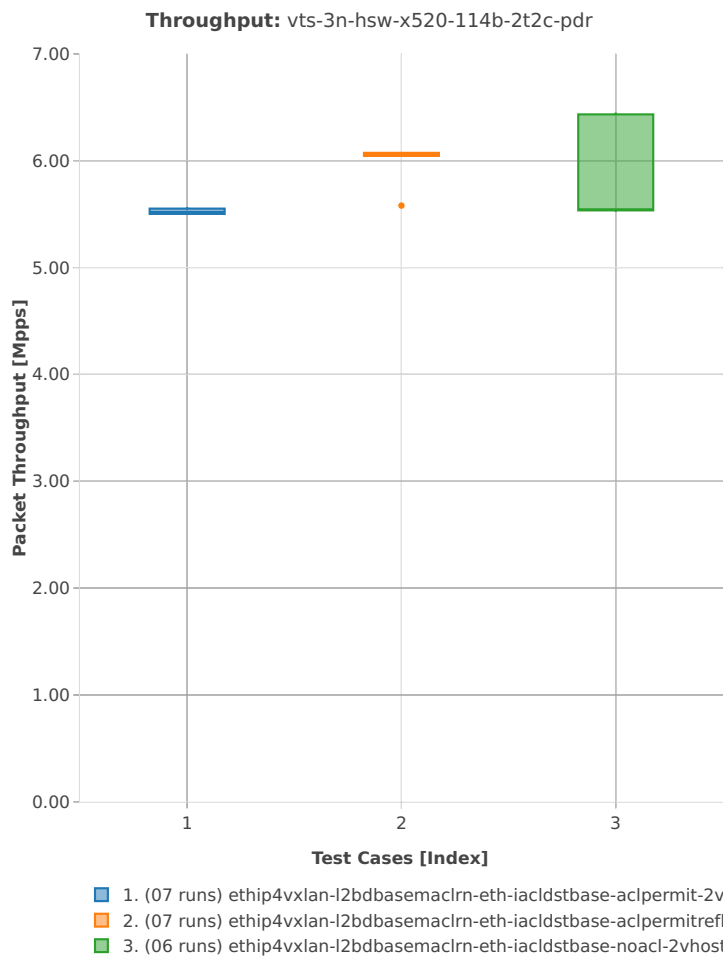

## 2.4 Speedup Multi-Core

Speedup Multi-Core throughput graphs are generated by multiple executions of the same performance tests across physical testbeds hosted LF FD.io labs: 3n-hsw, 2n-skx, 2n-skx. Grouped bars illustrate the 64B/78B packet throughput speedup ratio for 2- and 4-core multi-threaded VPP configurations relative to 1-core configurations.

Additional information about graph data:

1. **Graph Title:** describes tested packet path, testbed topology, processor model, NIC model, packet size used by data plane workers and indication of VPP DUT configuration.
2. **X-axis Labels:** number of cores.
3. **Y-axis Labels:** measured Packets Per Second [pps] throughput values.
4. **Graph Legend:** lists CSIT test suites executed to generate graphed test results.
5. **Hover Information:** lists number of runs executed, specific test substring, mean value of the measured packet throughput, calculated perfect throughput value, difference between measured and perfect values and relative speedup value.

---

**Note:** Test results have been generated by [FD.io test executor vpp performance job 3n-hsw<sup>52</sup>](#), [FD.io test executor vpp performance job 3n-skx<sup>53</sup>](#) and [FD.io test executor vpp performance job 2n-skx<sup>54</sup>](#) with RF result files csit-vpp-perf-1901-\*.zip [archived here](#). Required per test case data set size is **10**, but for VPP tests the actual size varies per test case and is  $\leq 10$ .

---

---

<sup>52</sup> <https://jenkins.fd.io/view/csit/job/csit-vpp-perf-verify-1901-3n-hsw>

<sup>53</sup> <https://jenkins.fd.io/view/csit/job/csit-vpp-perf-verify-1901-3n-skx>

<sup>54</sup> <https://jenkins.fd.io/view/csit/job/csit-vpp-perf-verify-1901-2n-skx>

### 2.4.1 L2 Ethernet Switching

Following sections include Throughput Speedup Analysis for VPP multi-core multi-thread configurations with no Hyper-Threading, specifically for tested 2t2c (2threads, 2cores) and 4t4c scenarios. 1t1c throughput results are used as a reference for reported speedup ratio. Input data used for the graphs comes from Phy-to-Phy 64B performance tests with VPP L2 Ethernet switching, including NDR throughput (zero packet loss) and PDR throughput (<0.5% packet loss).

CSIT source code for the test cases used for above plots can be found in [CSIT git repository](#)<sup>55</sup>.

---

<sup>55</sup> <https://git.fd.io/csit/tree/tests/vpp/perf/l2?h=rls1901>

3n-hsw-x520

64b-base\_and\_scale

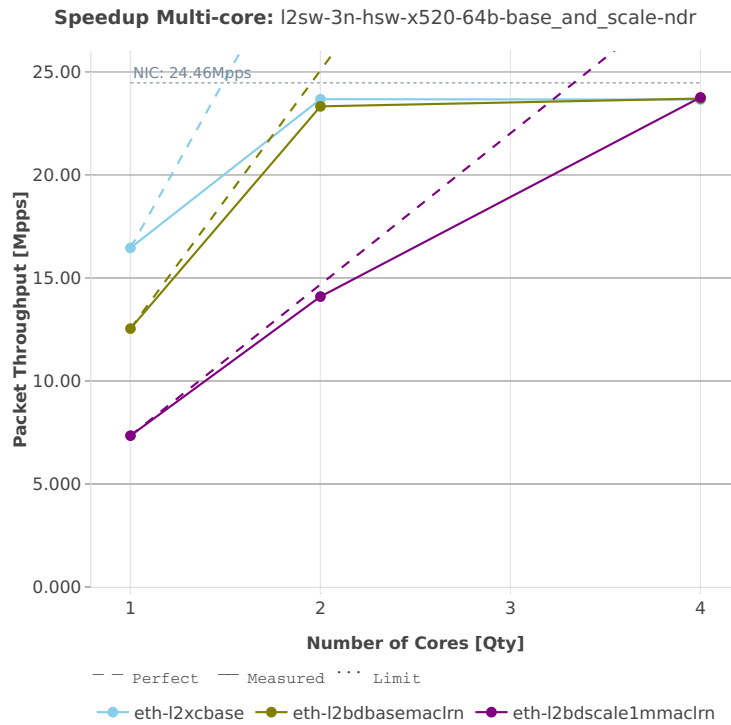



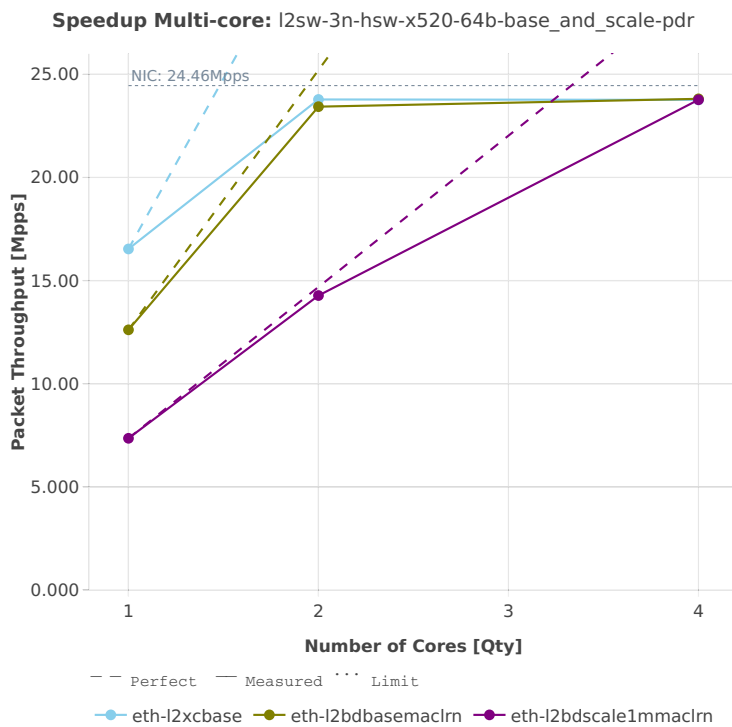

64b-features

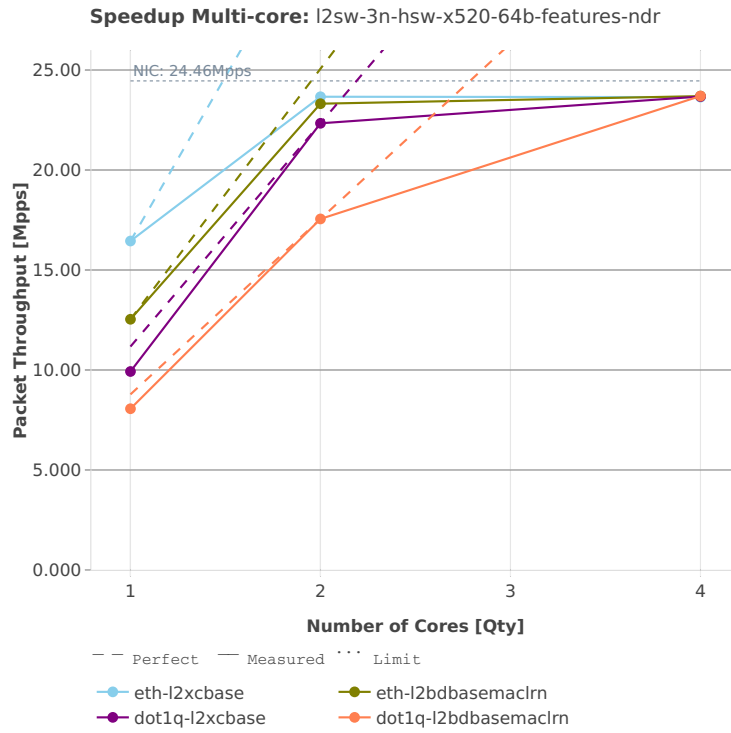

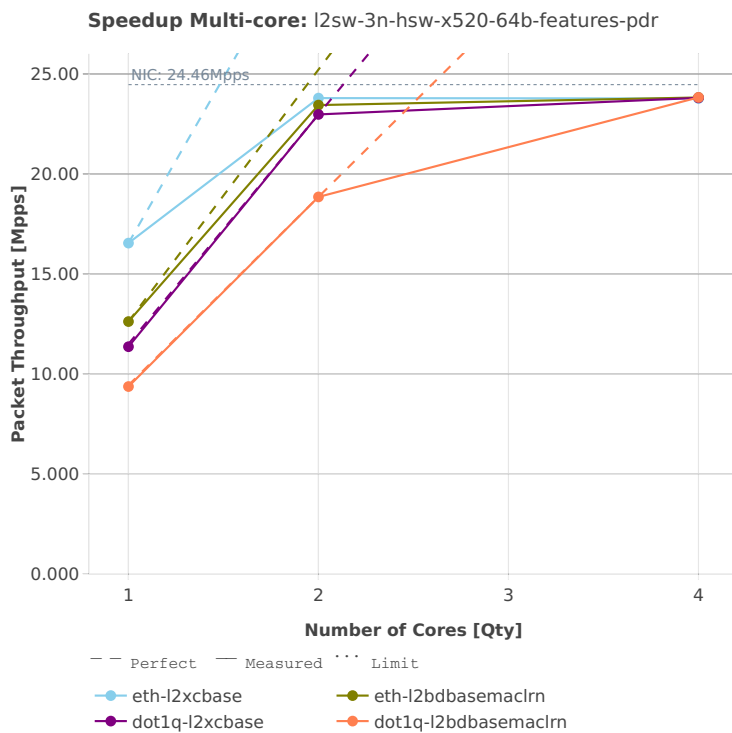

3n-hsw-x710

64b-base\_and\_scale

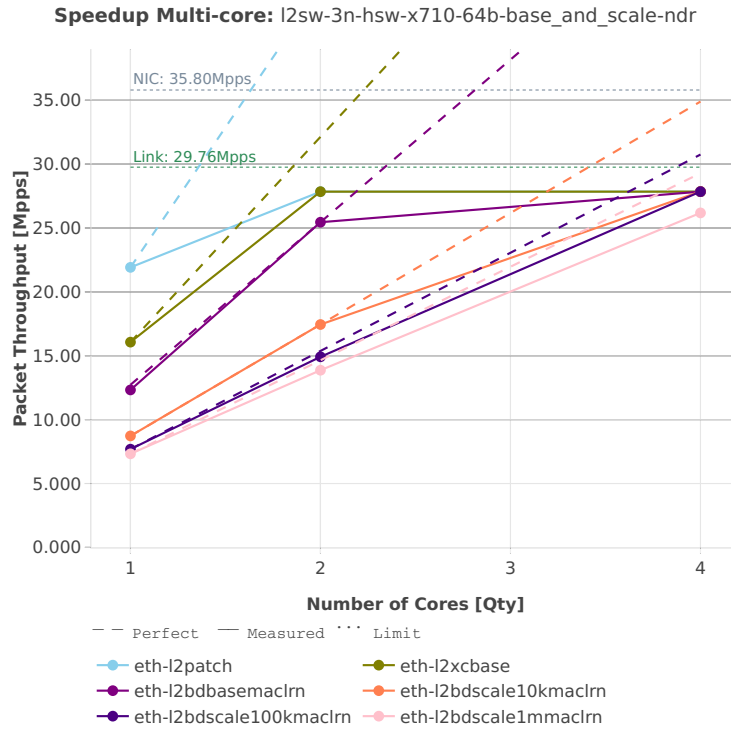

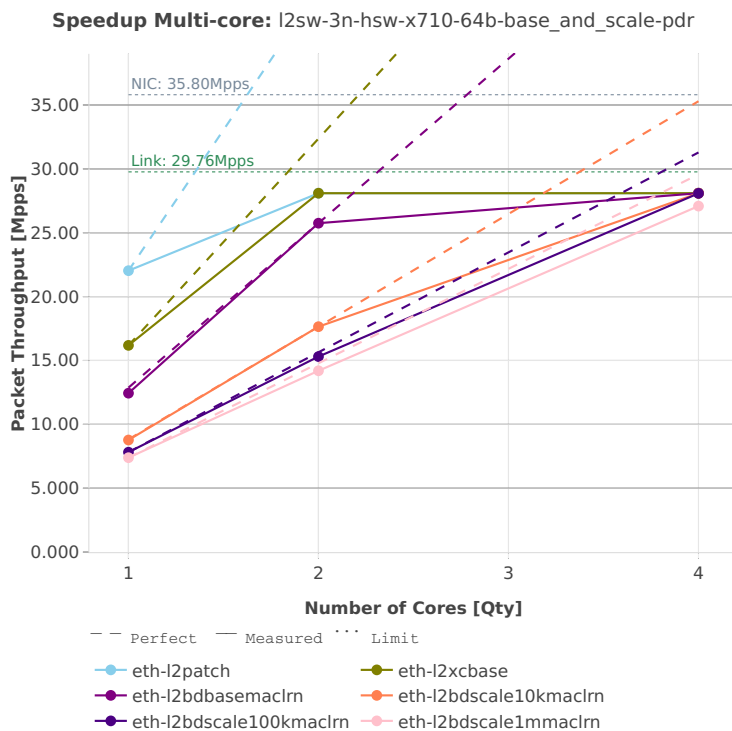

64b-features

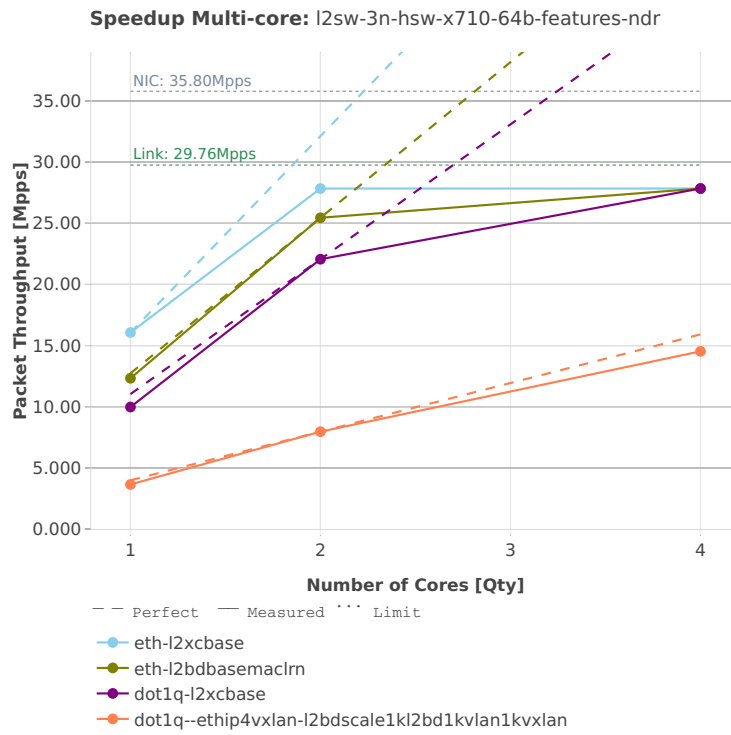

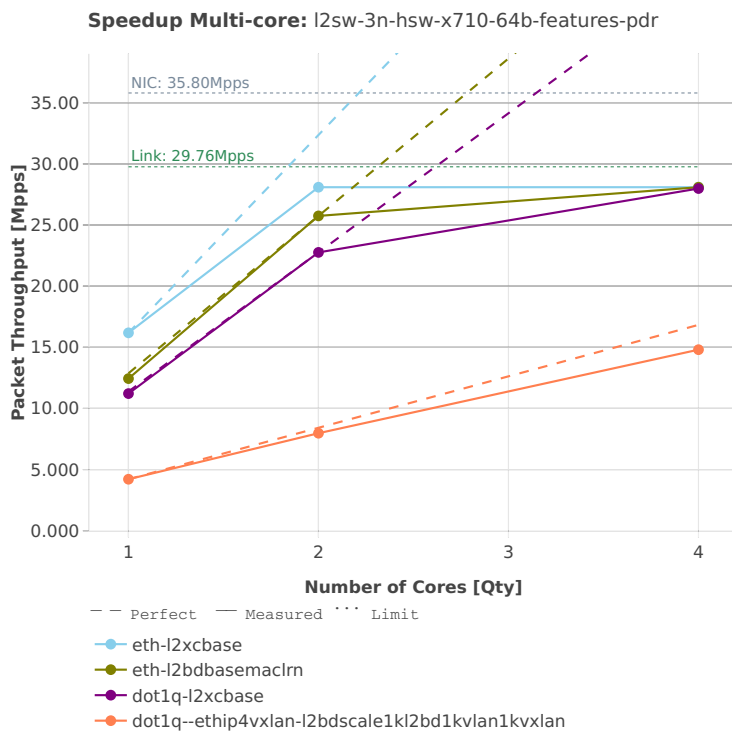

3n-hsw-xl710

64b-base\_and\_scale

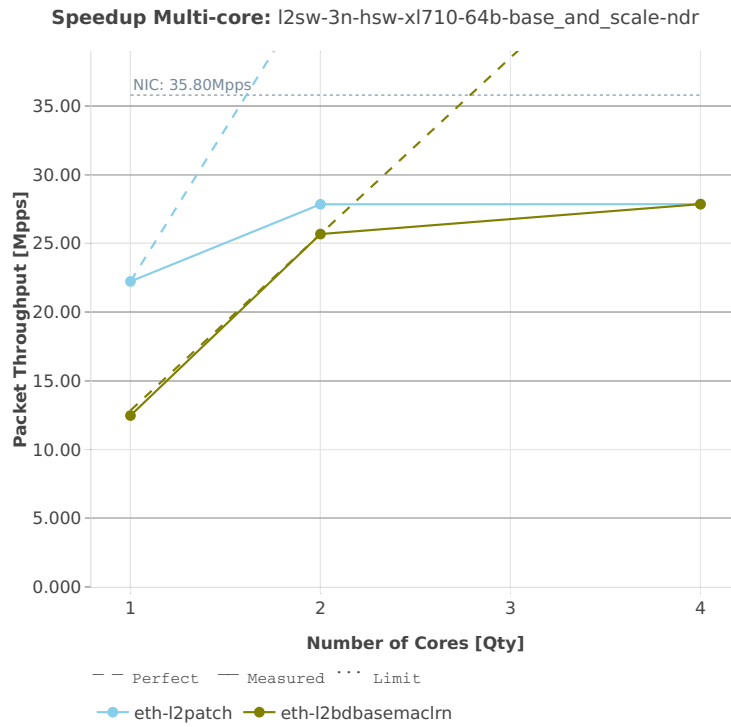



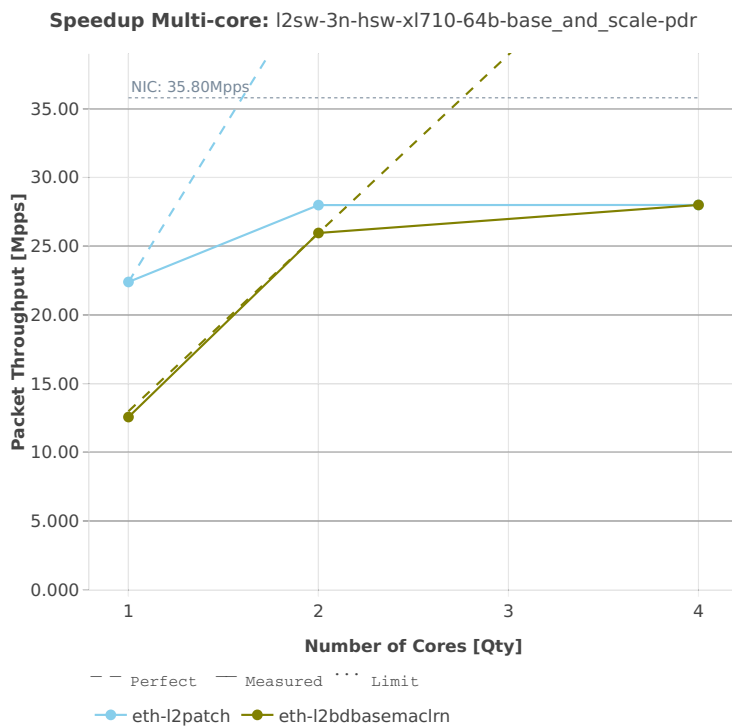

3n-skx-x710

64b-base\_and\_scale

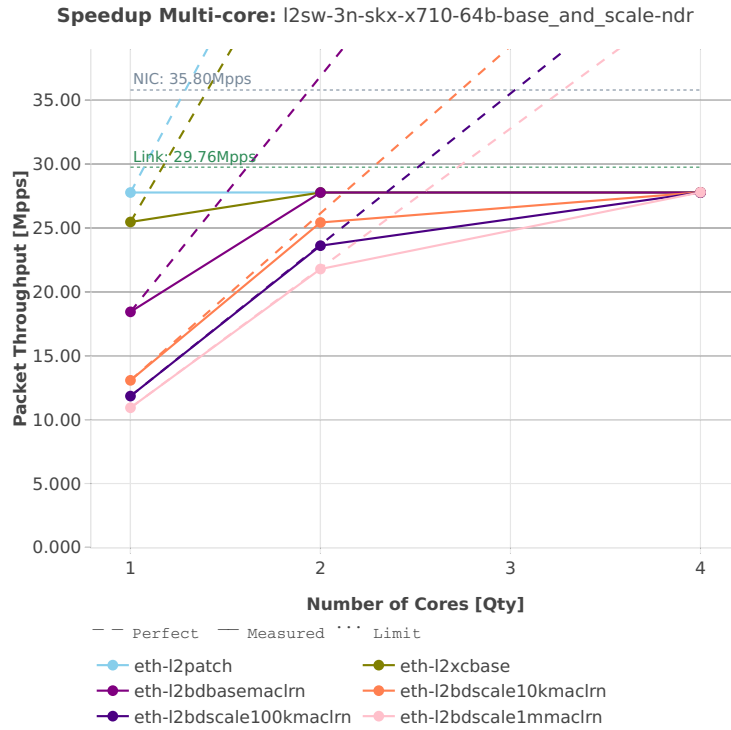

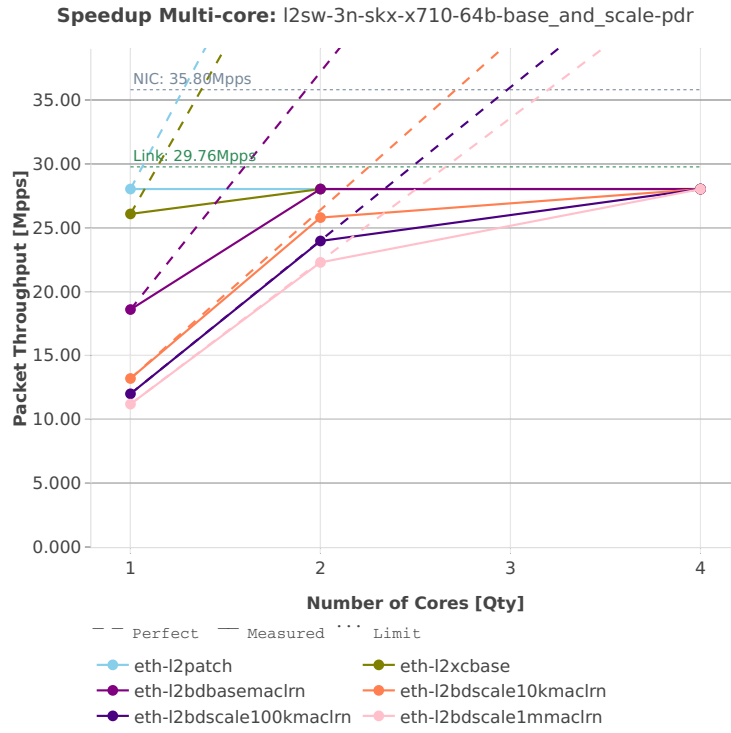

64b-features

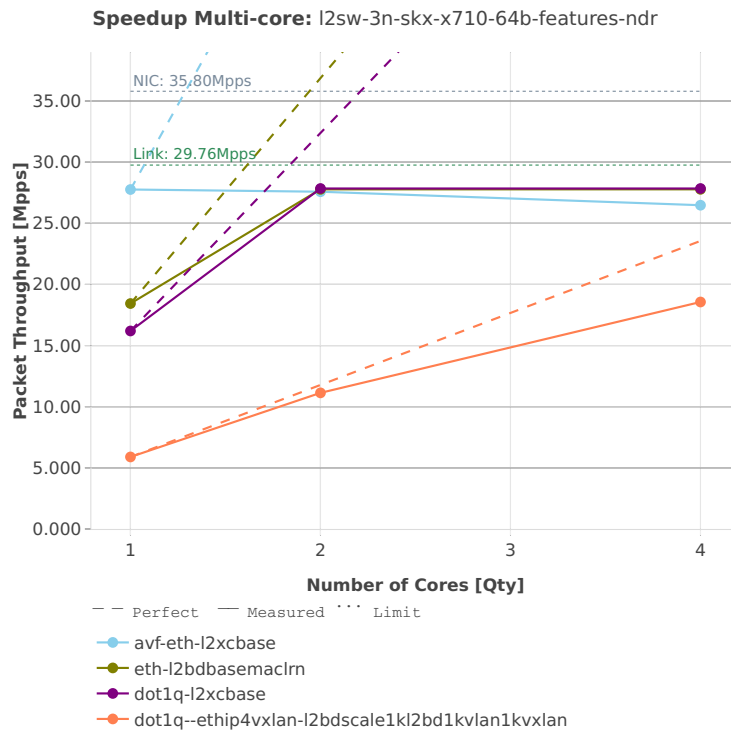

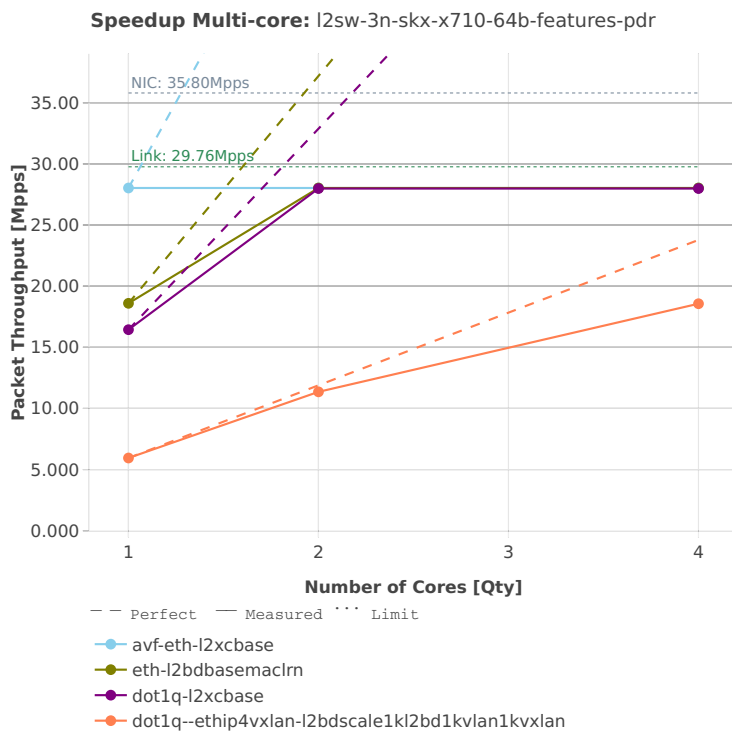

3n-skx-xxv710

64b-base\_and\_scale

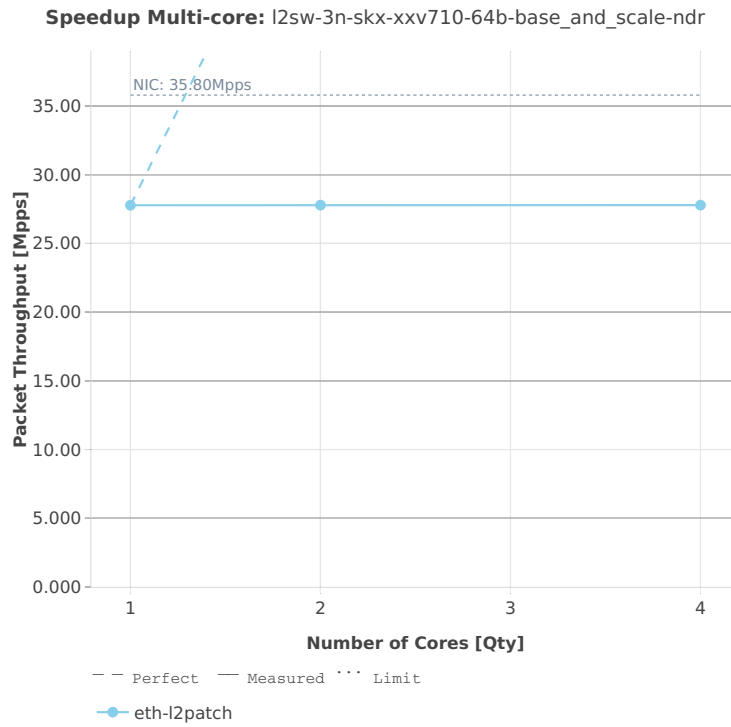

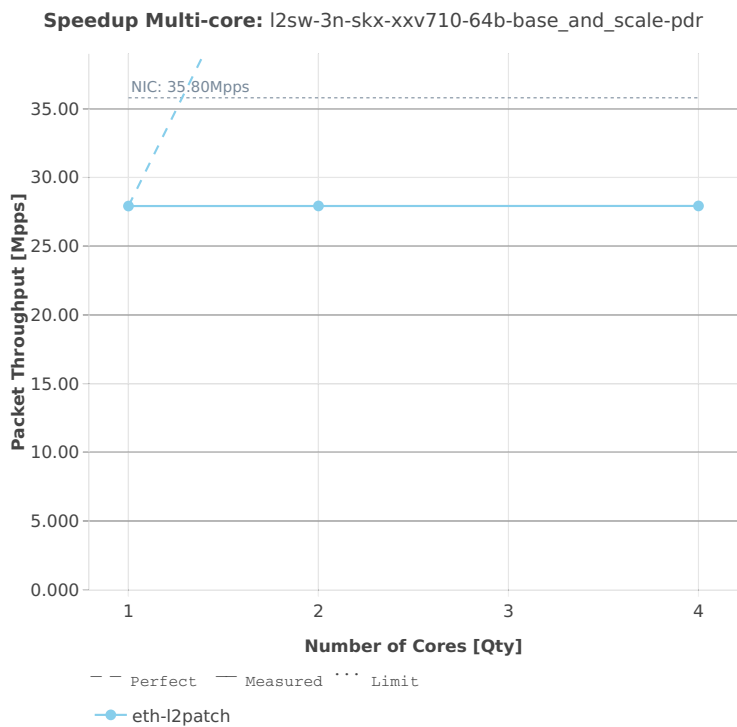

2n-skx-x710

64b-base\_and\_scale

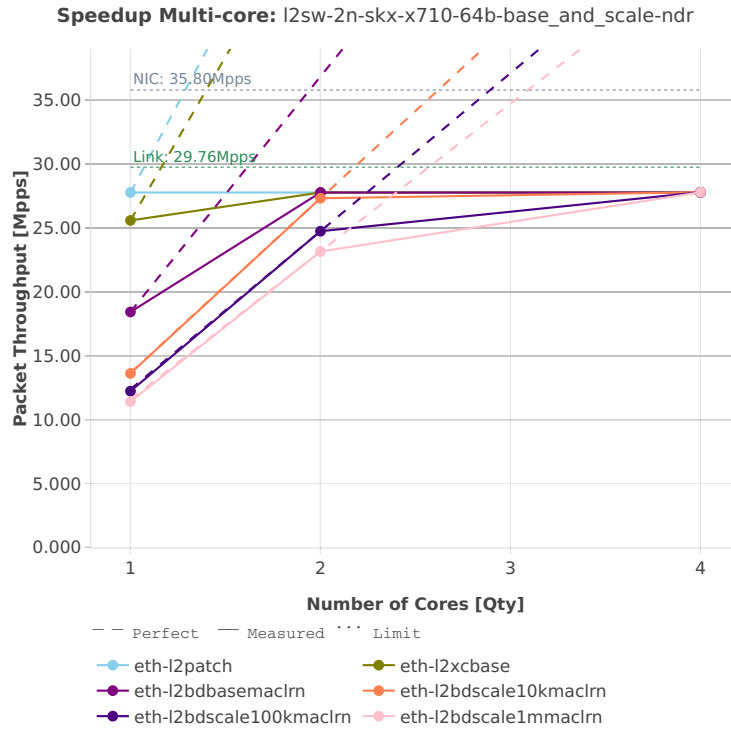



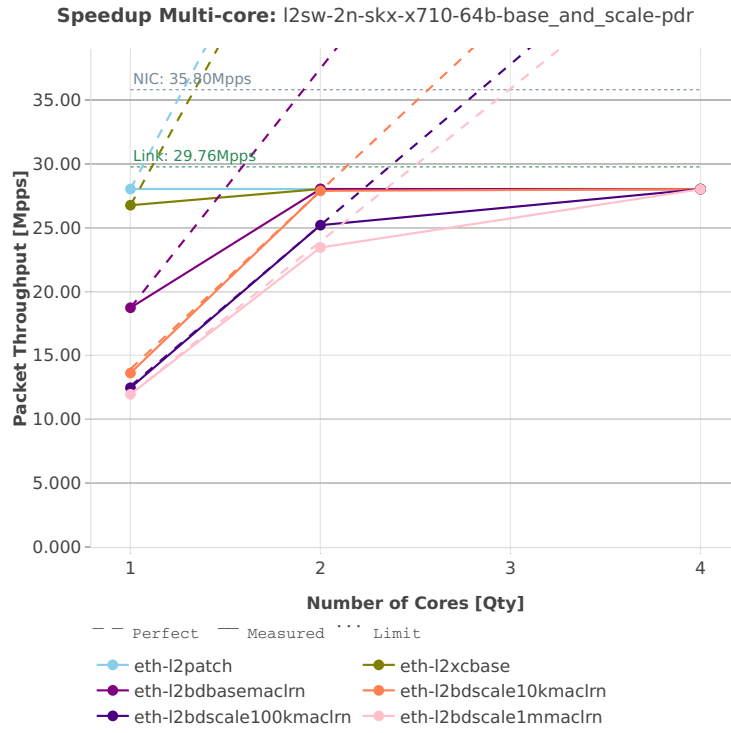

2n-skx-xxv710

64b-base\_and\_scale

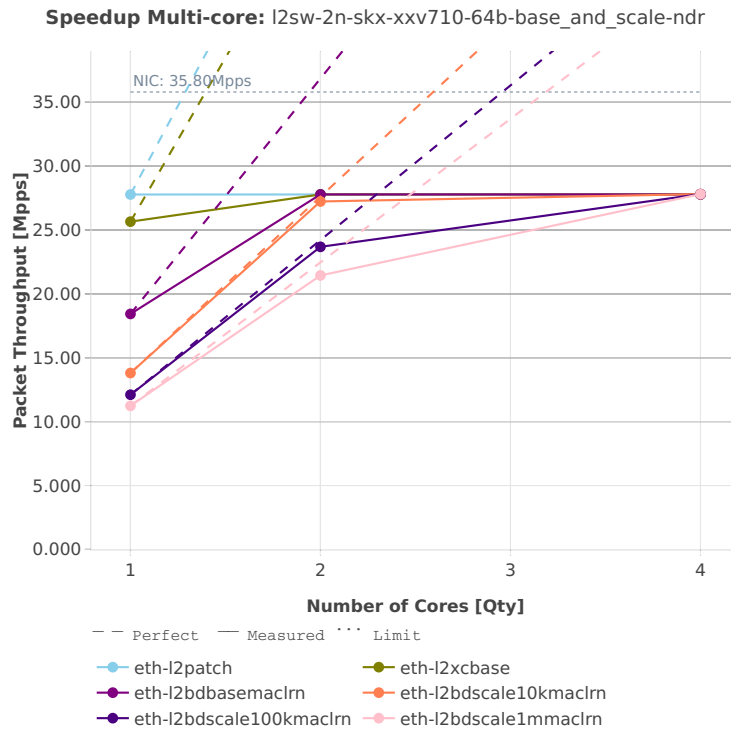

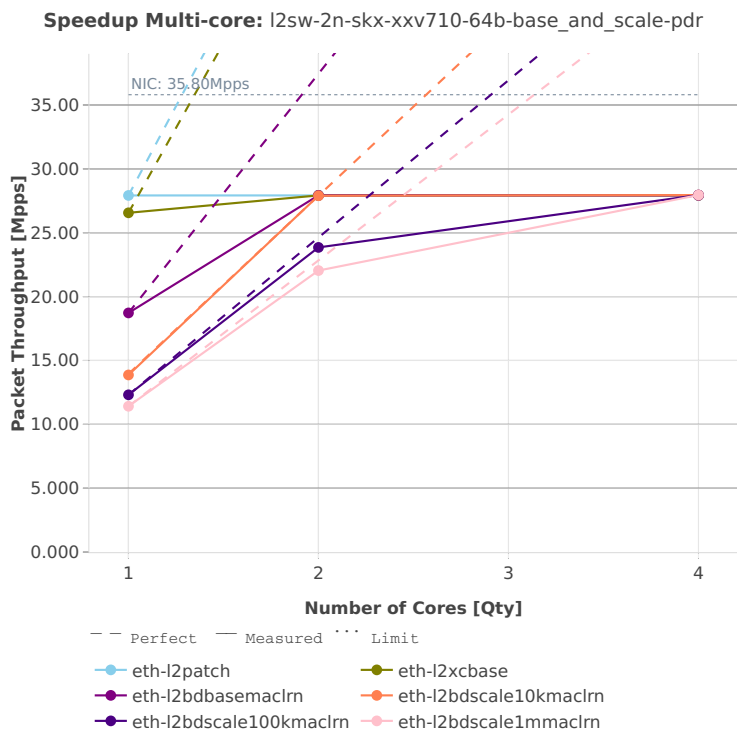

## 2.4.2 IPv4 Routing

Following sections include Throughput Speedup Analysis for VPP multi-core multi-thread configurations with no Hyper-Threading, specifically for tested 2t2c (2threads, 2cores) and 4t4c scenarios. 1t1c throughput results are used as a reference for reported speedup ratio. Input data used for the graphs comes from Phy-to-Phy 64B performance tests with VPP IPv4 Routed-Forwarding, including NDR throughput (zero packet loss) and PDR throughput (<0.5% packet loss).

CSIT source code for the test cases used for plots can be found in [CSIT git repository](#)<sup>56</sup>.

---

<sup>56</sup> <https://git.fd.io/csit/tree/tests/vpp/perf/ip4?h=rls1901>

3n-hsw-x520

64b-base\_and\_scale

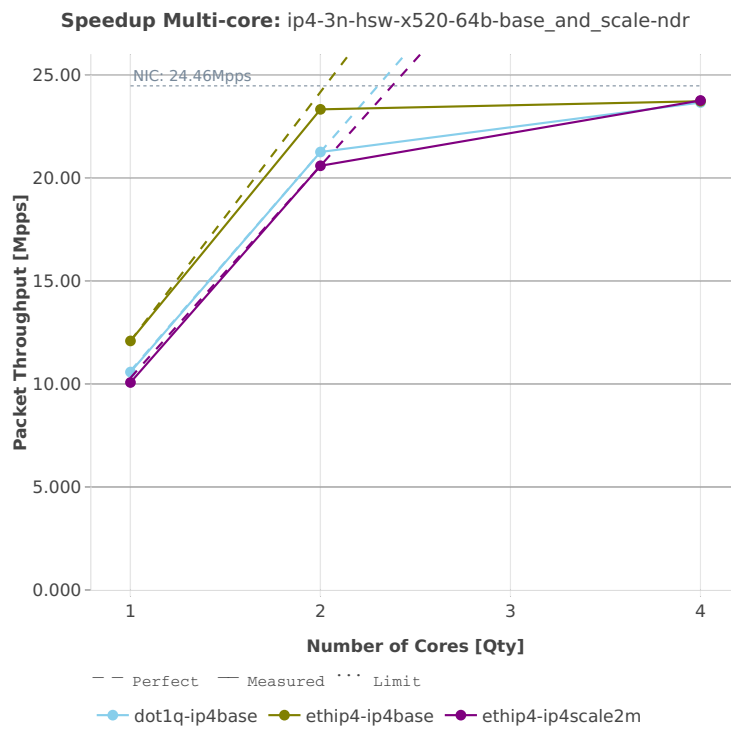

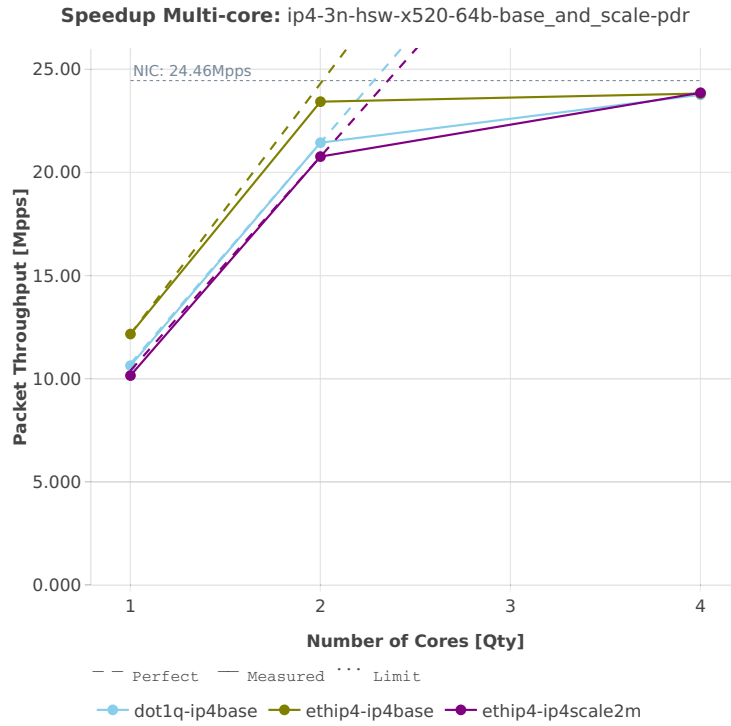

64b-features

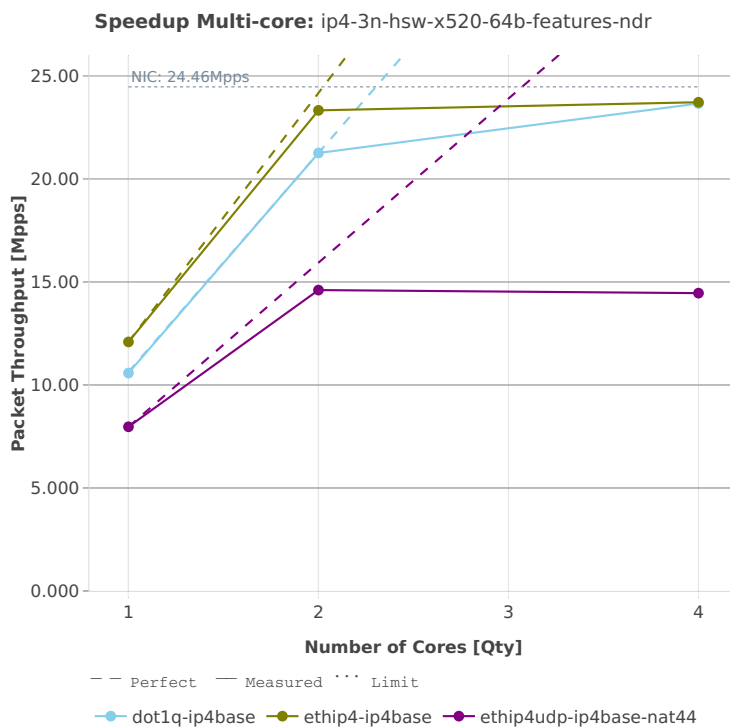

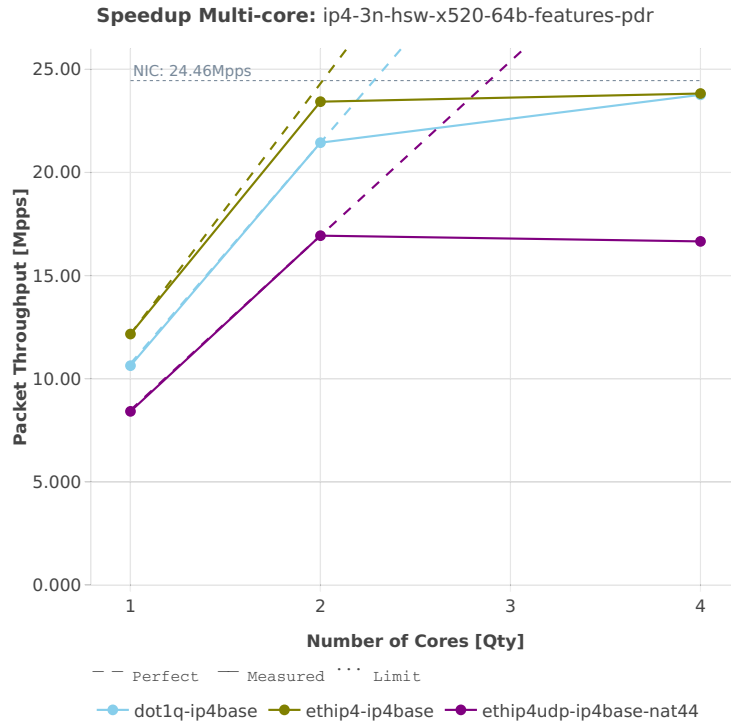



64b-features-nat44

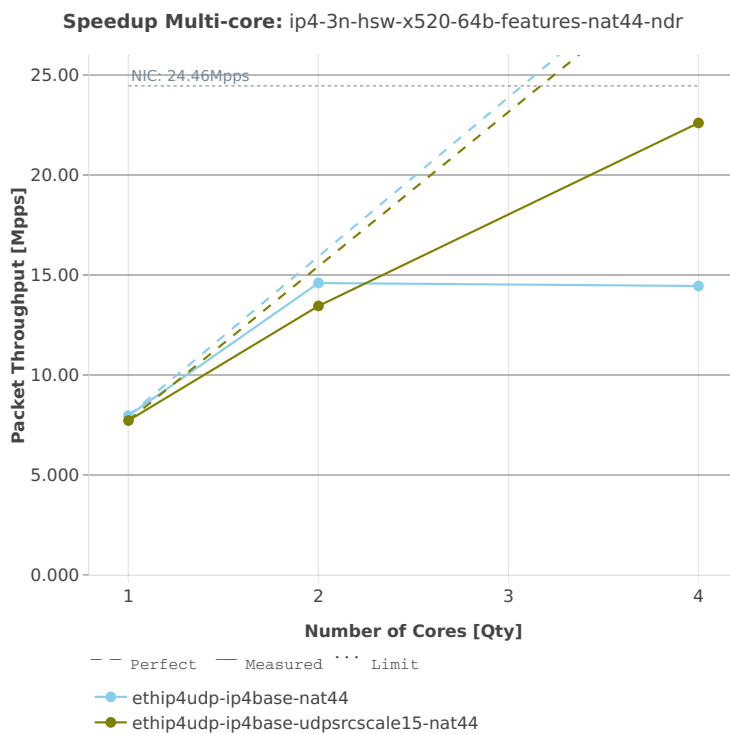

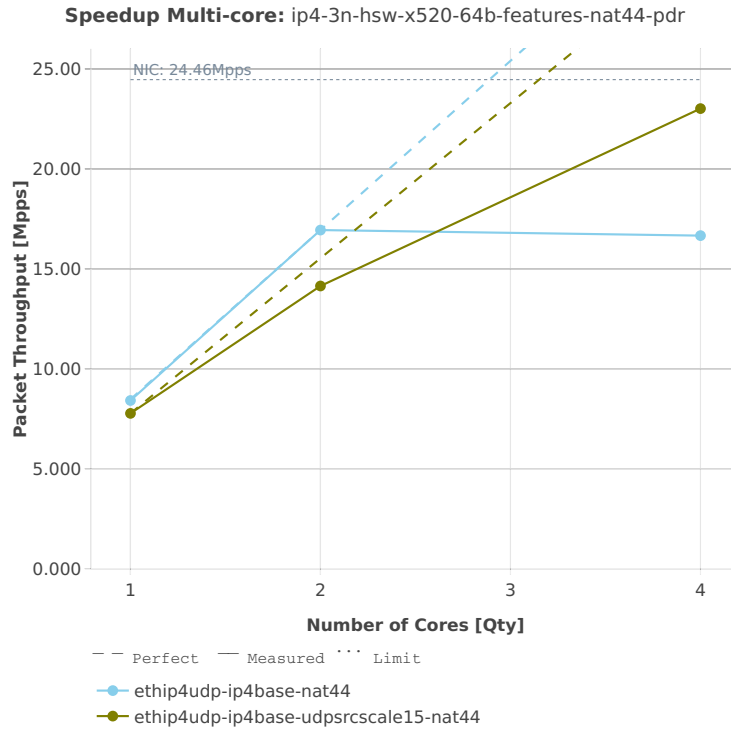

64b-features-iacl

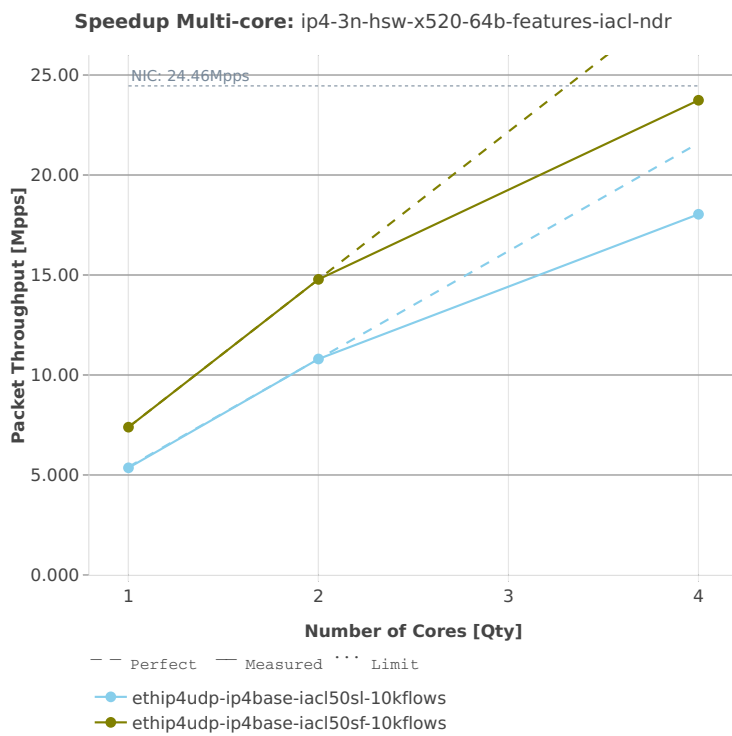

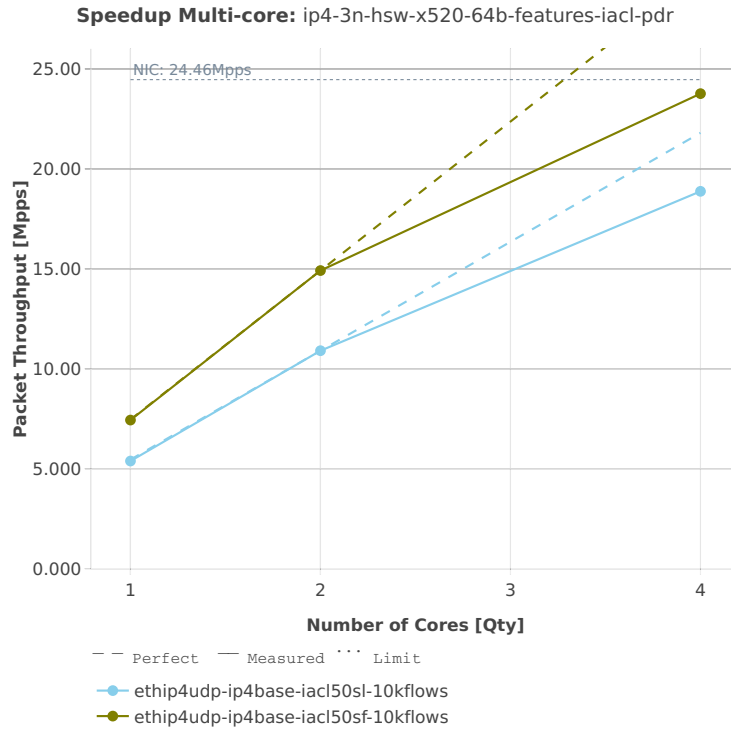

64b-features-oacl

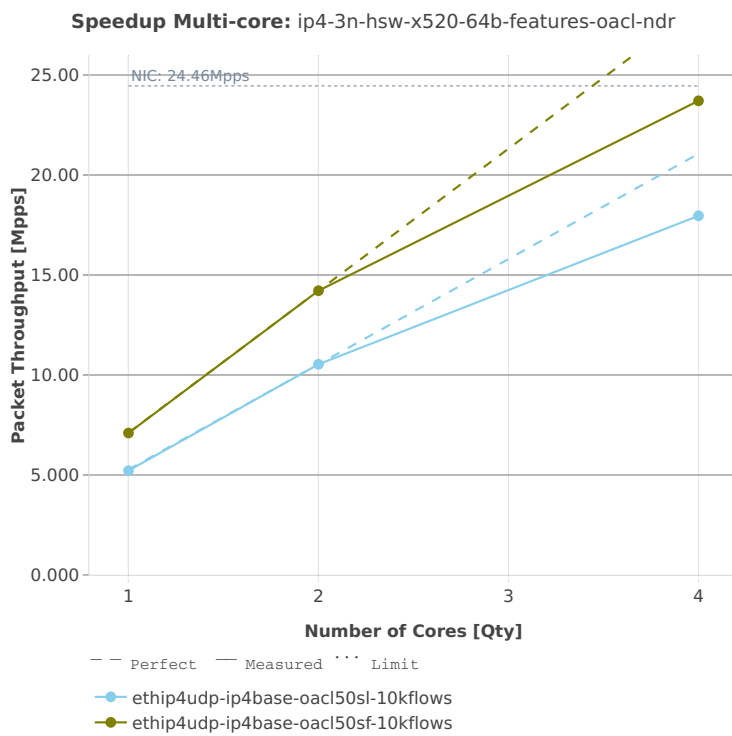

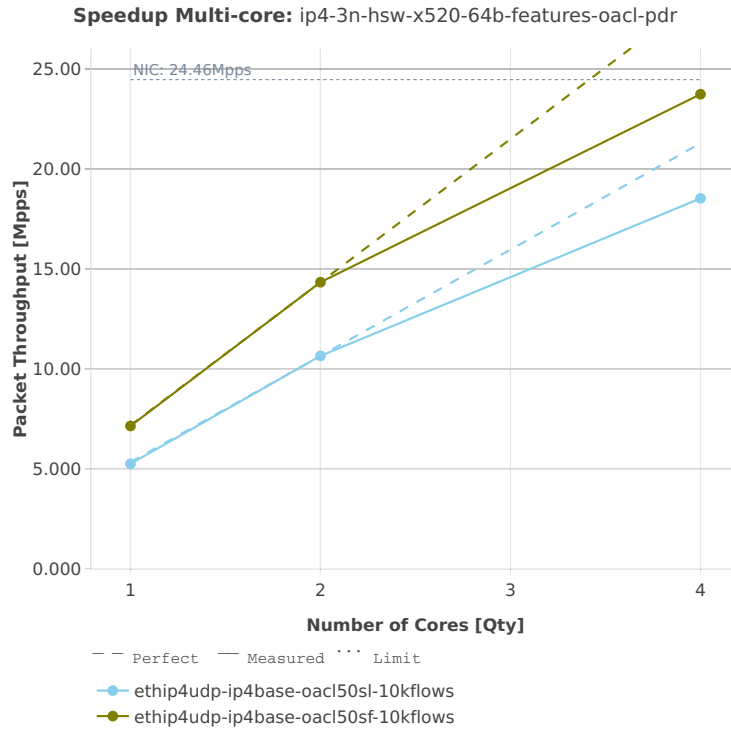

3n-hsw-x710

64b-base\_and\_scale

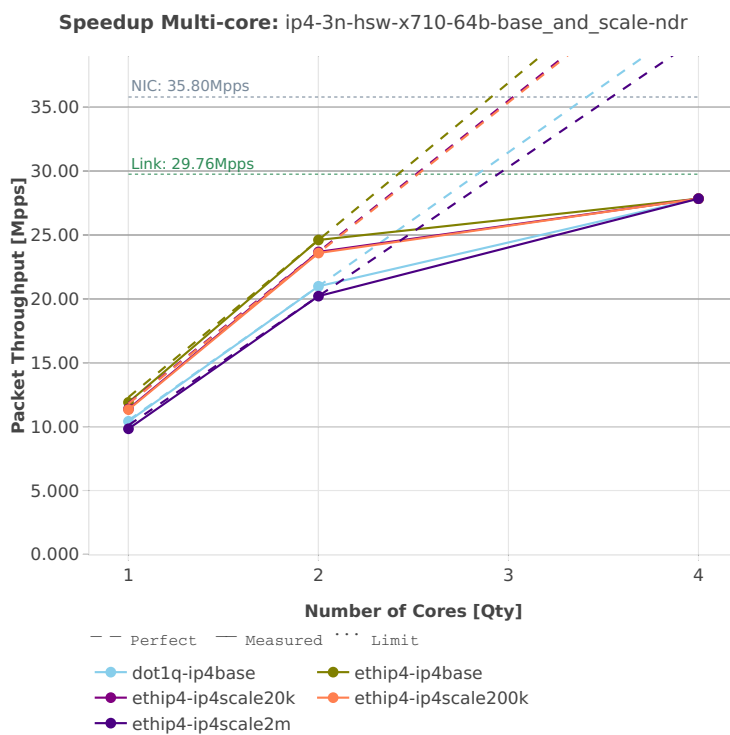

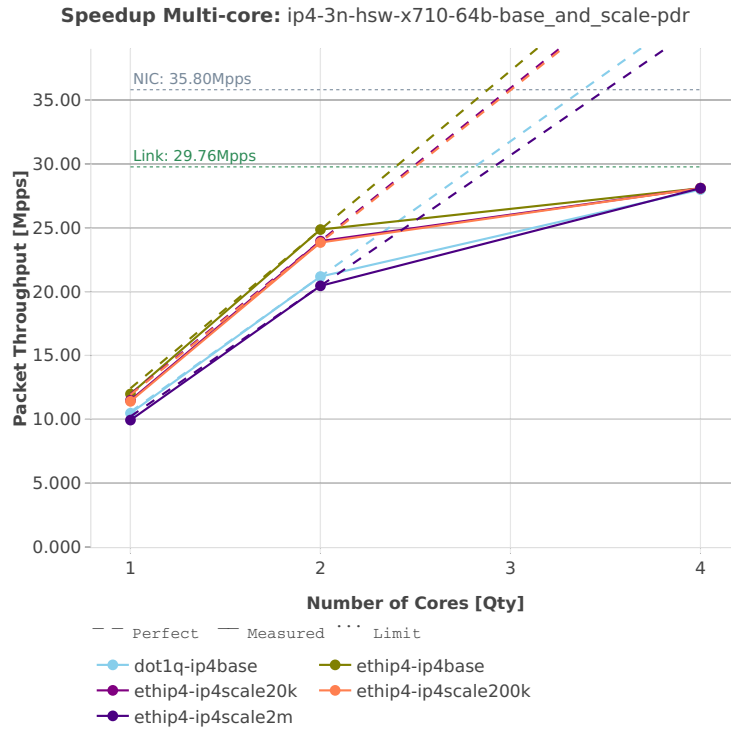



64b-features

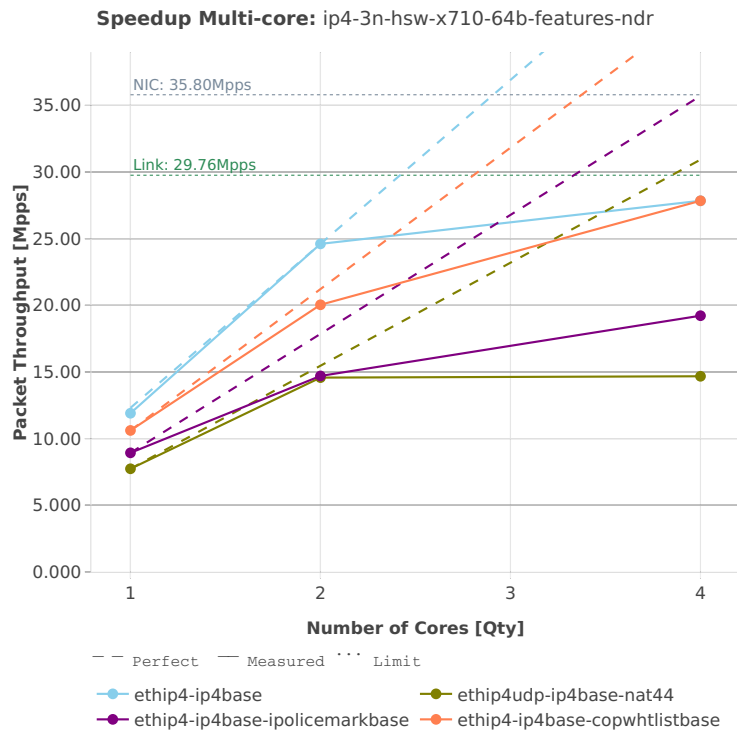

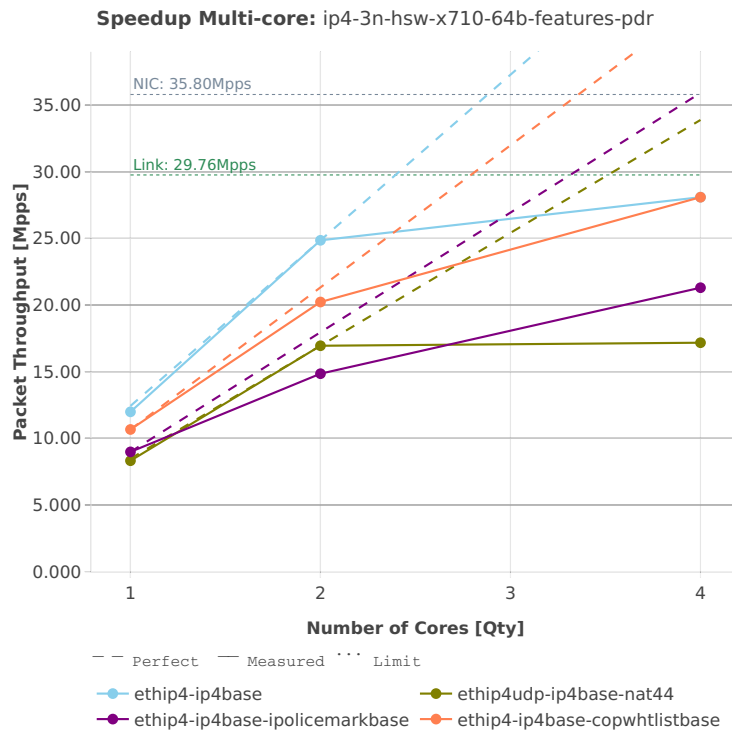

64b-features-nat44

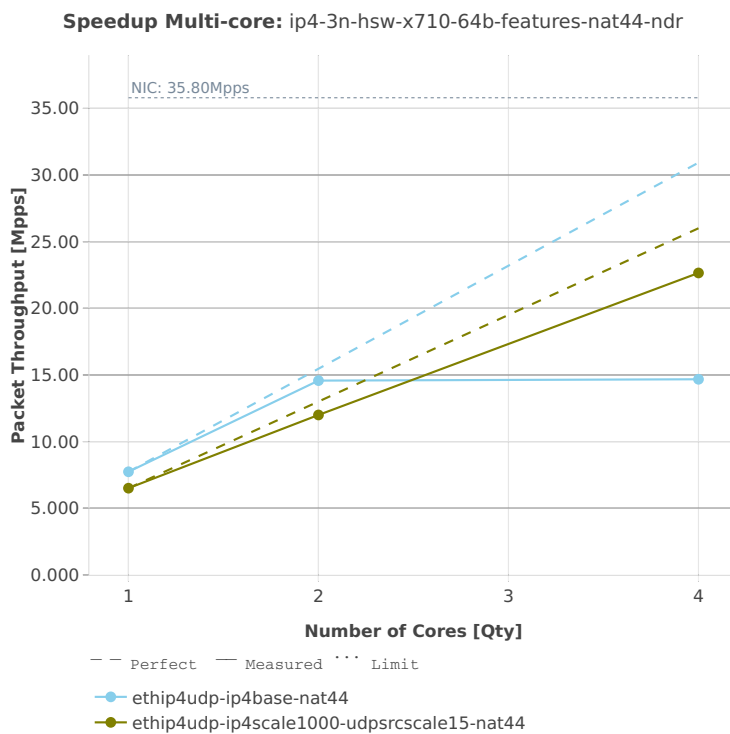

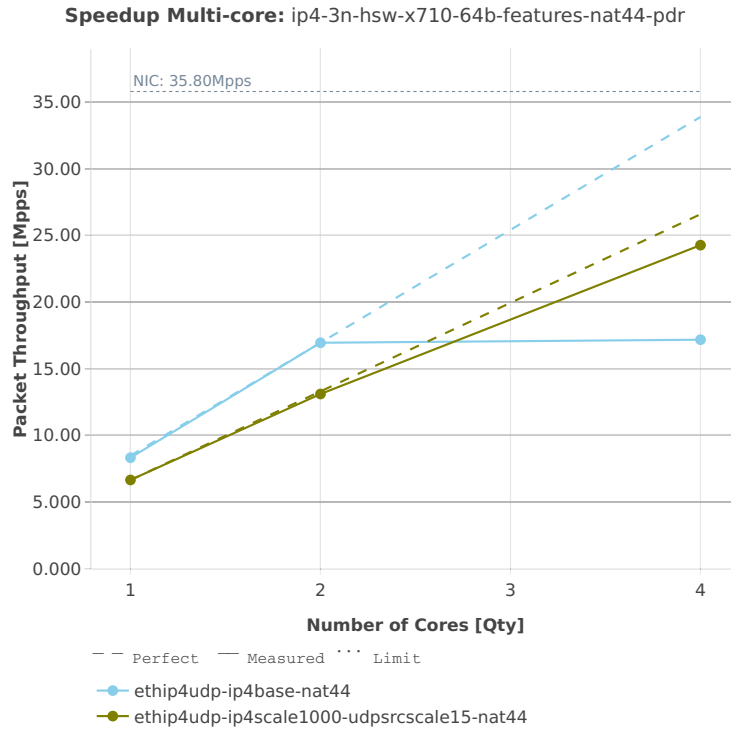

64b-features-iacl

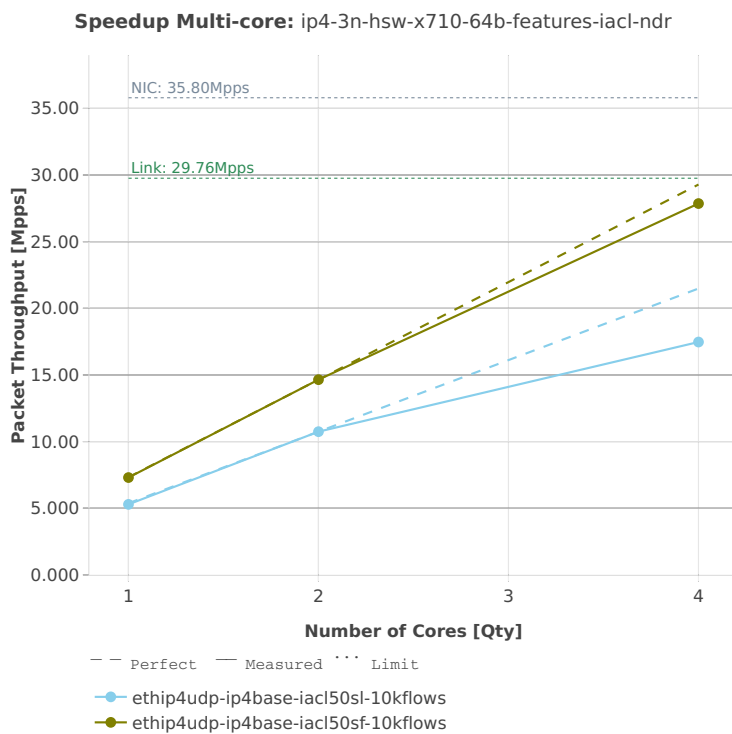

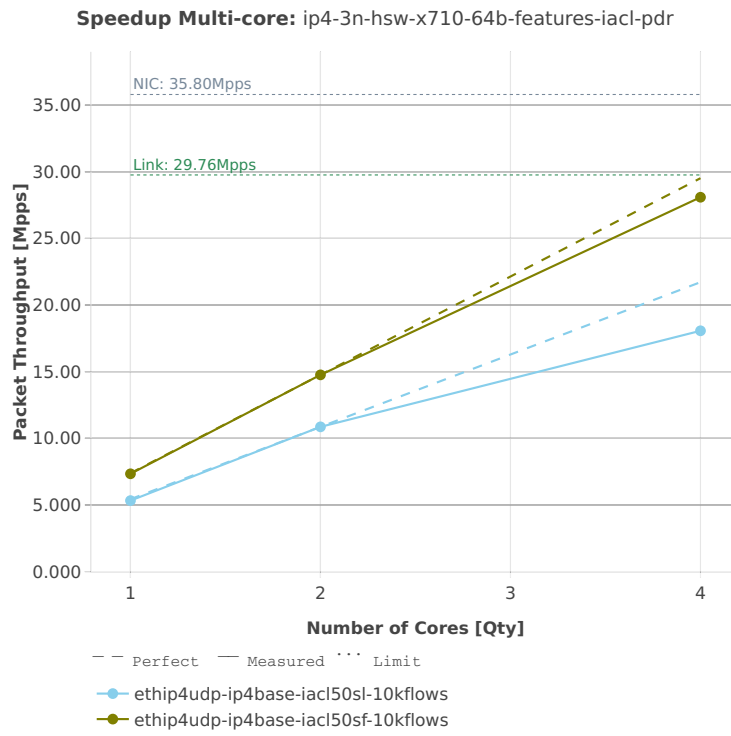

3n-hsw-xl710

64b-base\_and\_scale

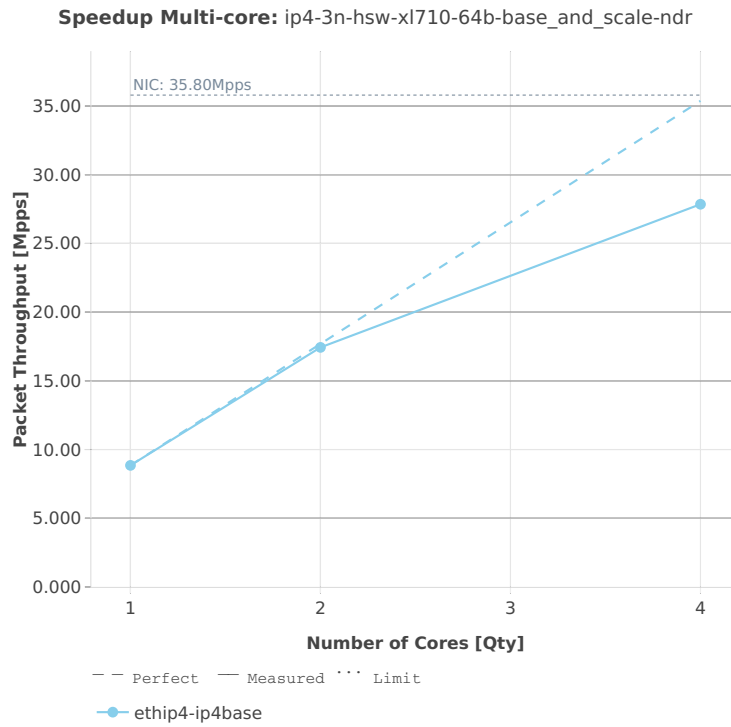

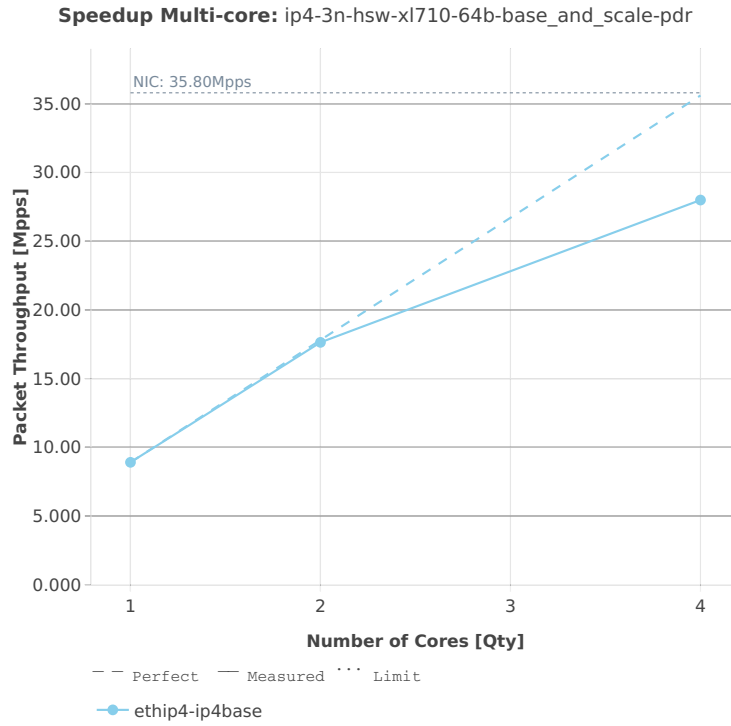



3n-skx-x710

64b-base\_and\_scale

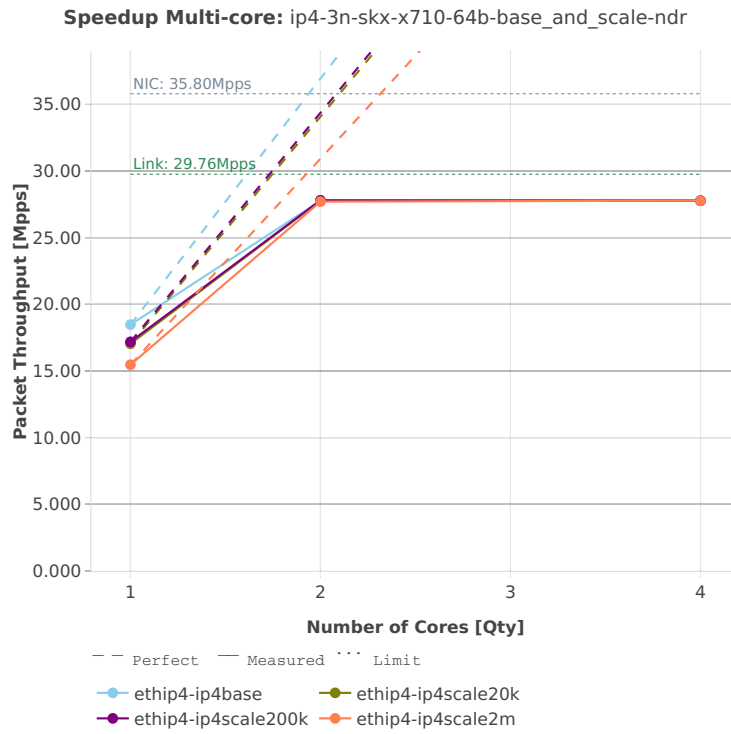

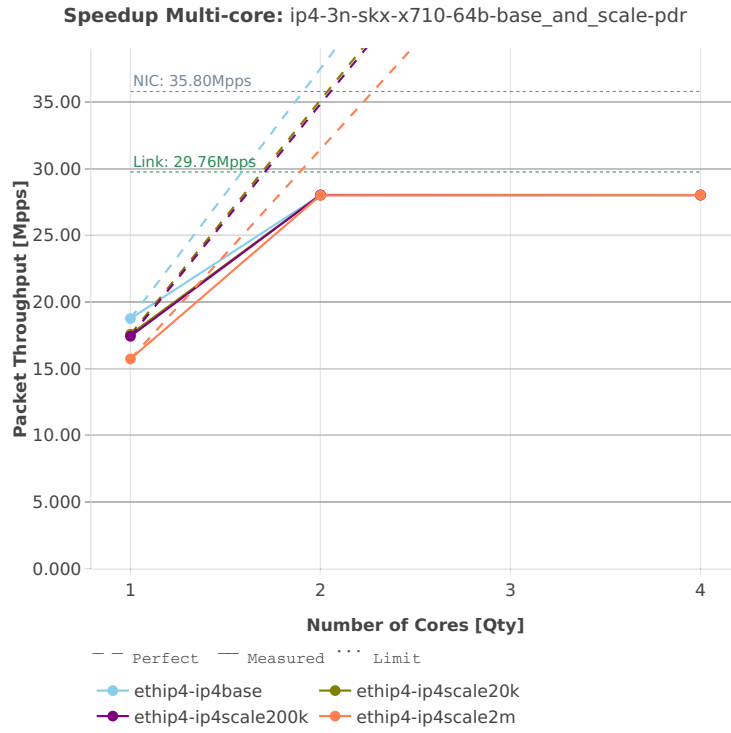

64b-features

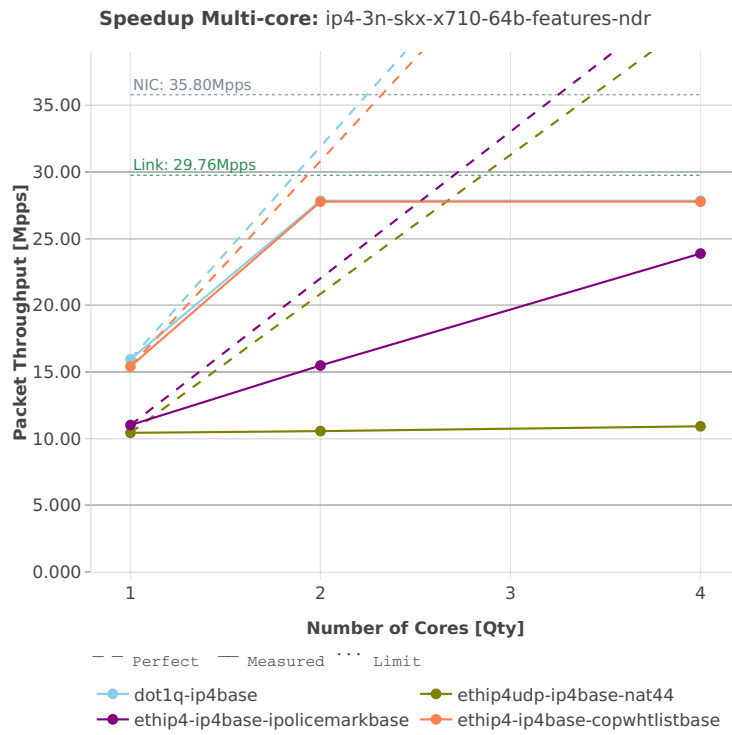

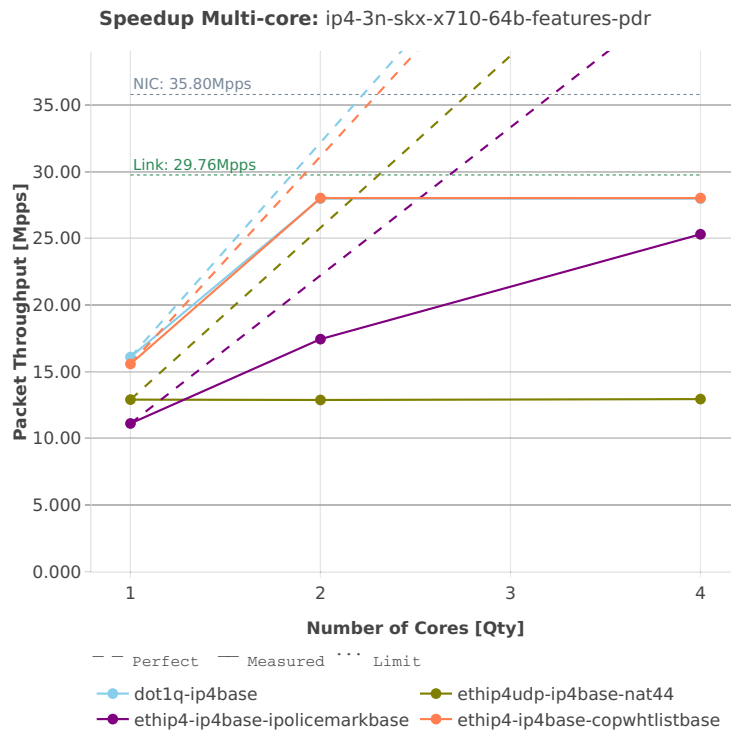

64b-features-nat44

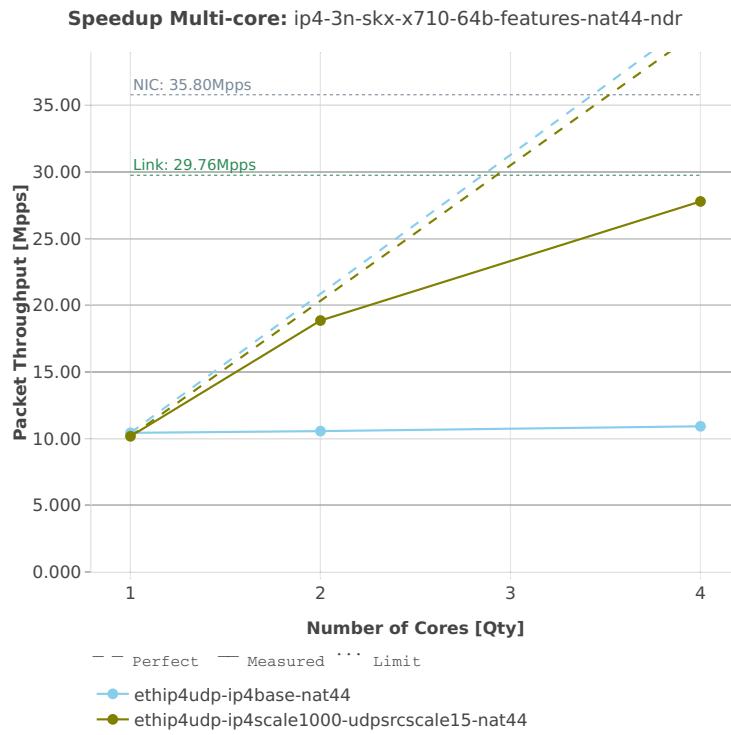

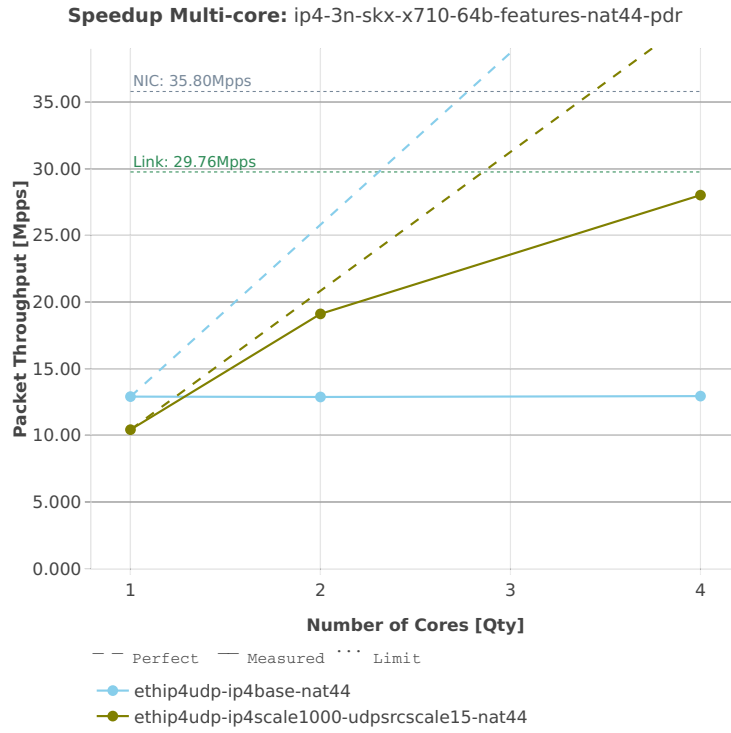

64b-features-iacl

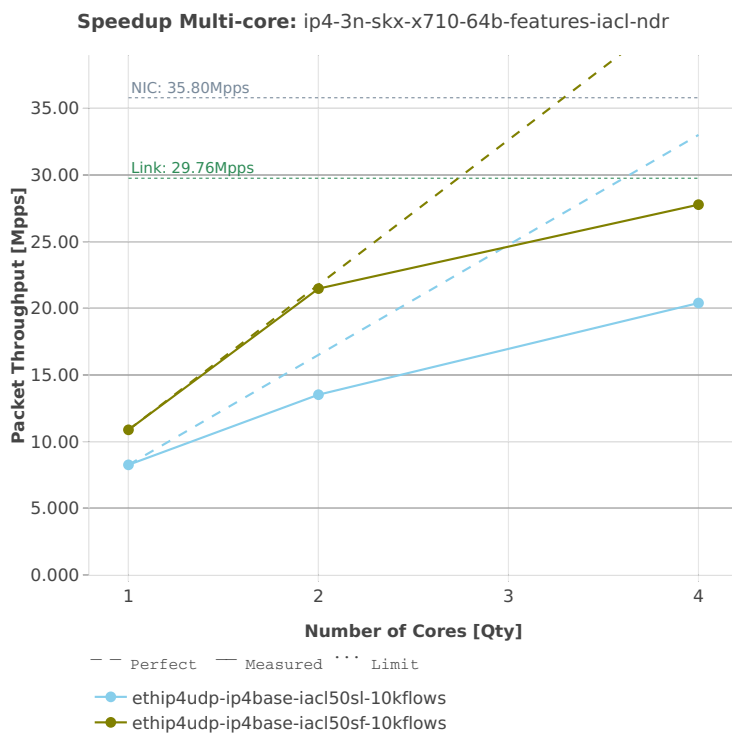

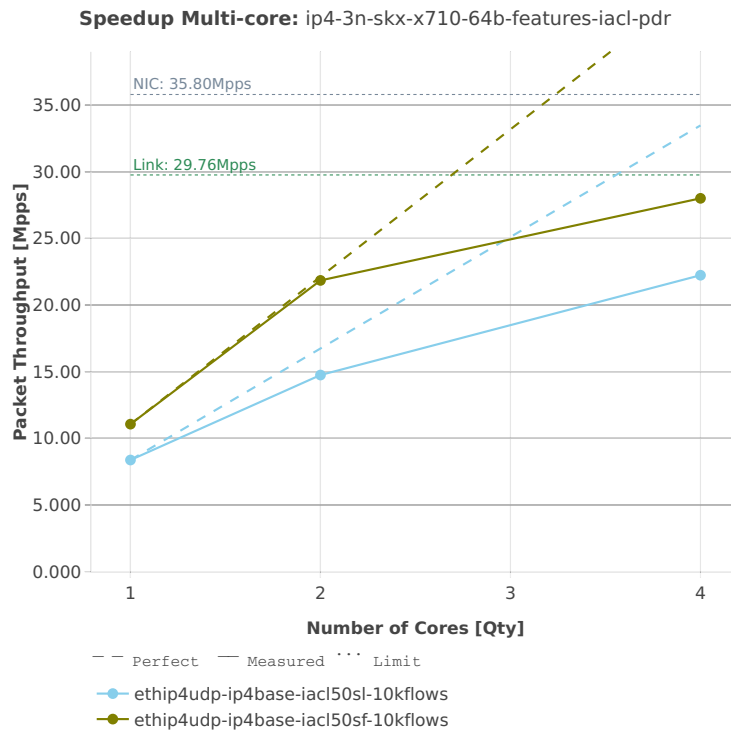



64b-features-nat44

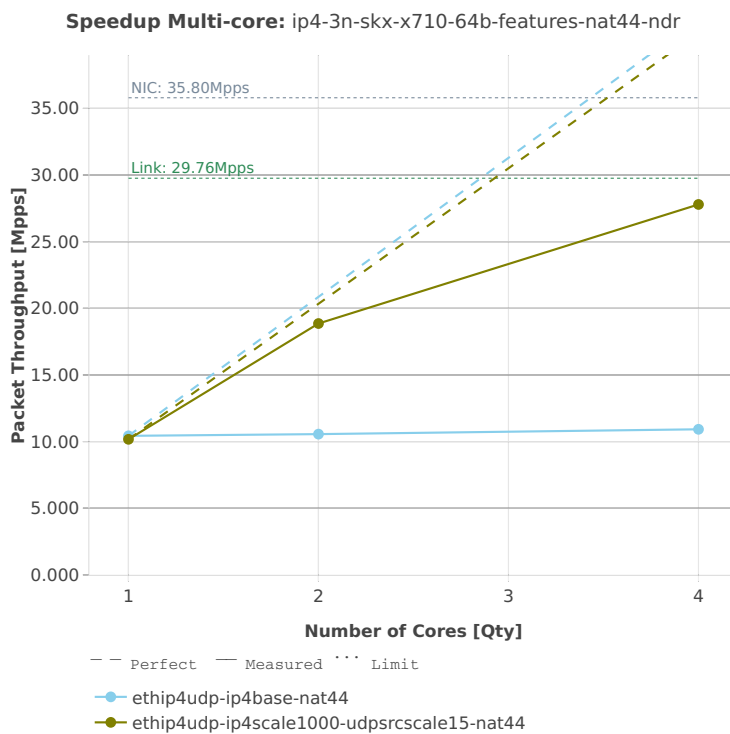

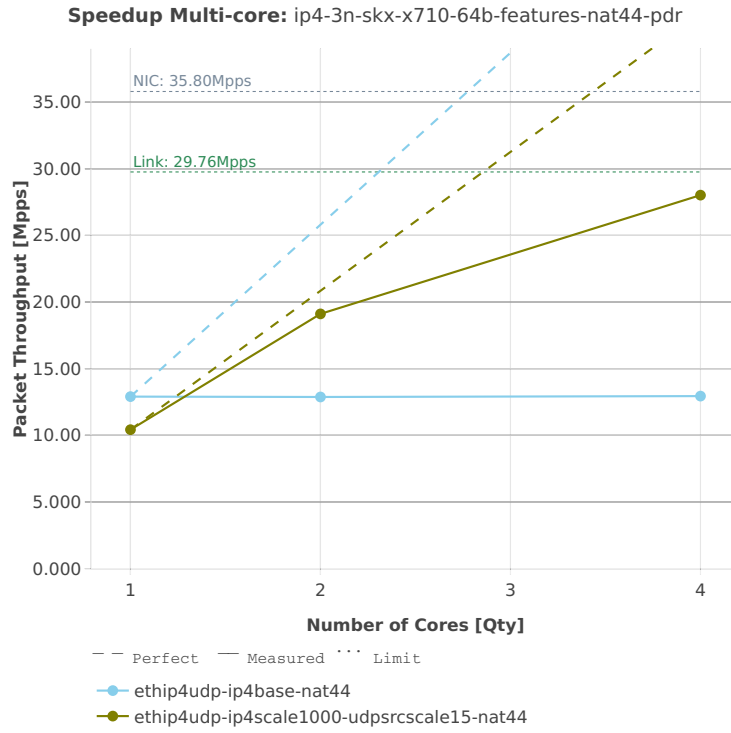

2n-skx-x710

64b-base\_and\_scale

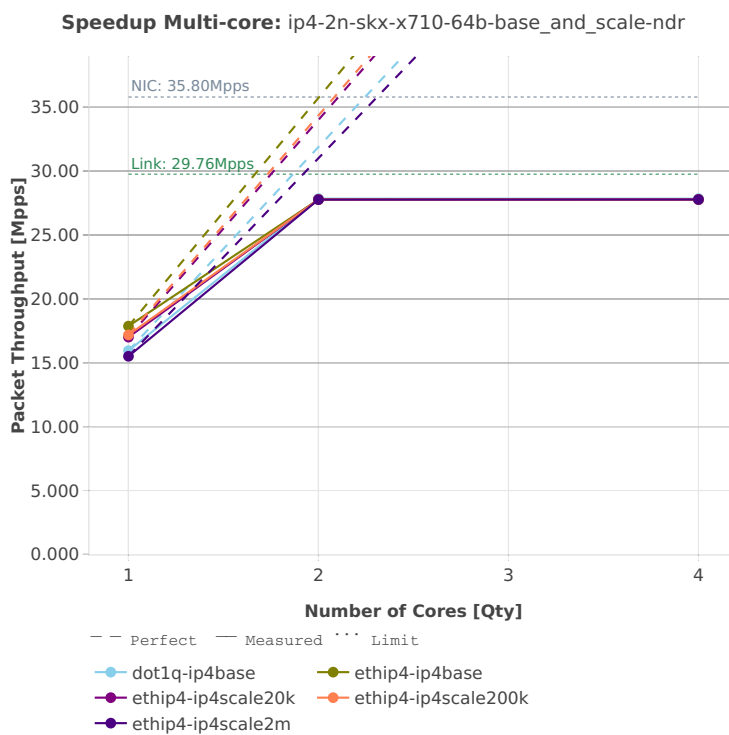

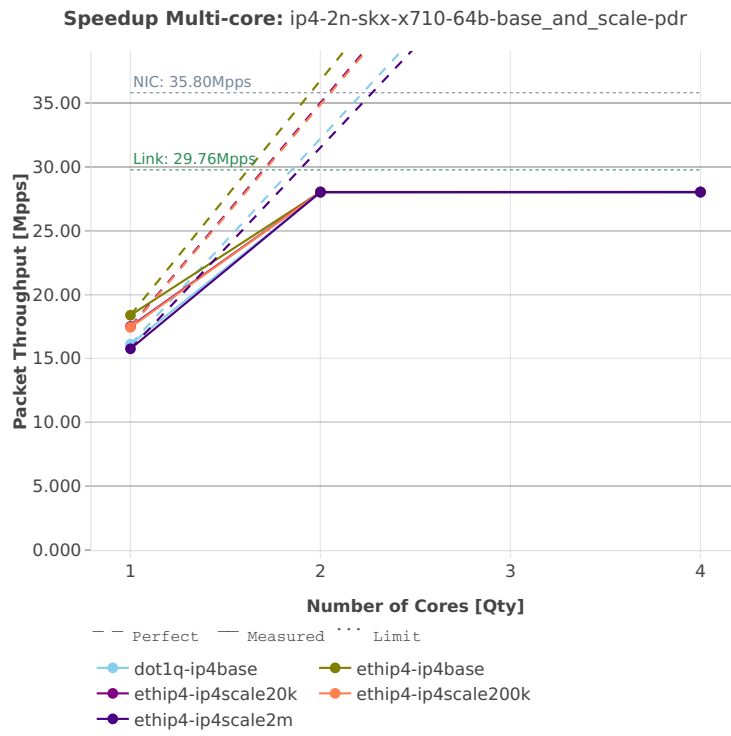

2n-skx-xxv710

64b-base\_and\_scale

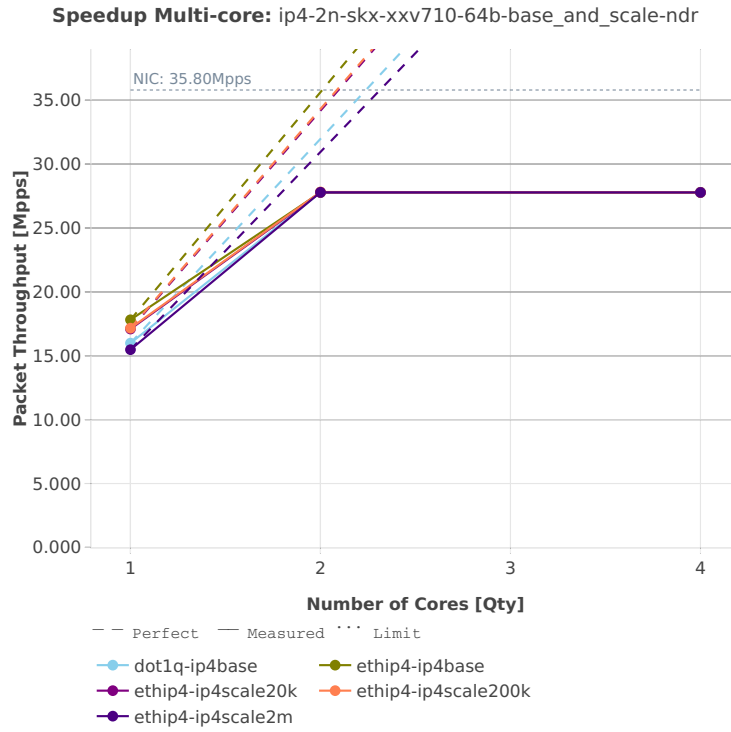

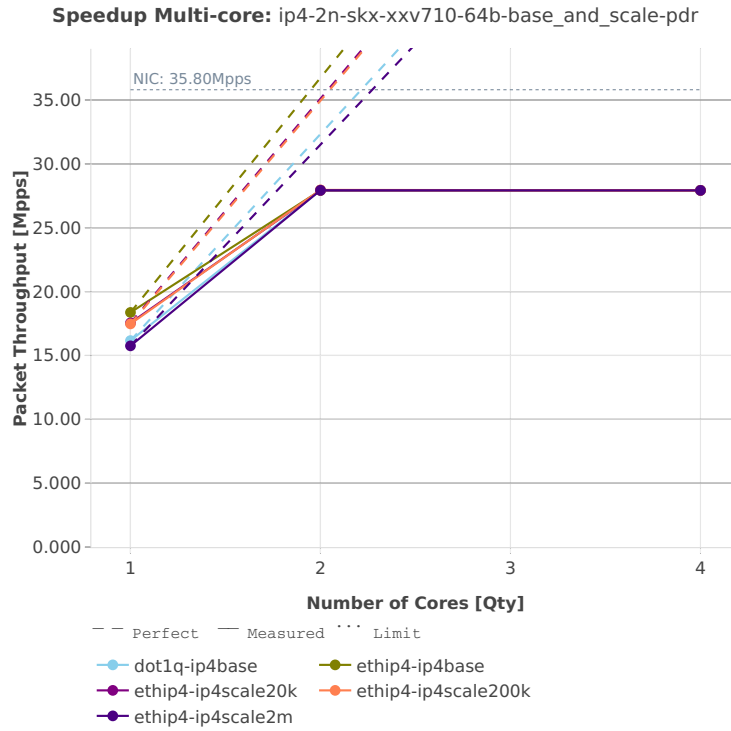

### 2.4.3 IPv6 Routing

Following sections include Throughput Speedup Analysis for VPP multi-core multi-thread configurations with no Hyper-Threading, specifically for tested 2t2c (2threads, 2cores) and 4t4c scenarios. 1t1c throughput results are used as a reference for reported speedup ratio. Input data used for the graphs comes from Phy-to-Phy 78B performance tests with VPP IPv6 Routed-Forwarding, including NDR throughput (zero packet loss) and PDR throughput (<0.5% packet loss).

CSIT source code for the test cases used for plots can be found in [CSIT git repository](#)<sup>57</sup>.

---

<sup>57</sup> <https://git.fd.io/csit/tree/tests/vpp/perf/ip6?h=rls1901>

3n-hsw-x520

78b-base\_and\_scale

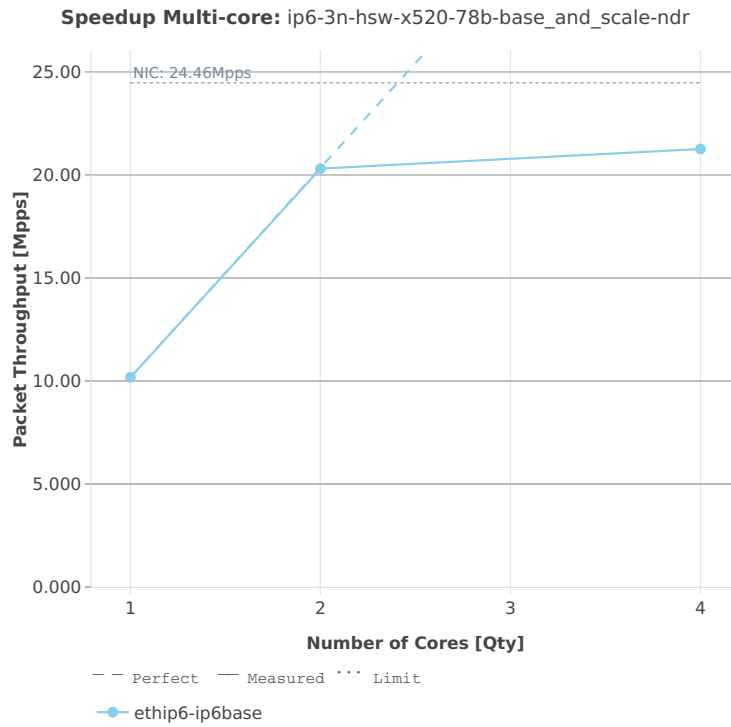



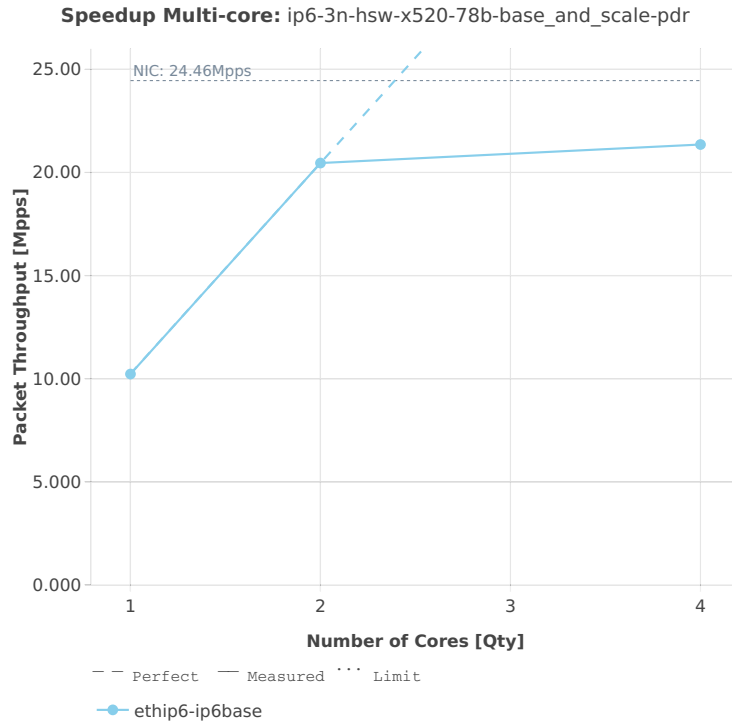

78b-base\_and\_features

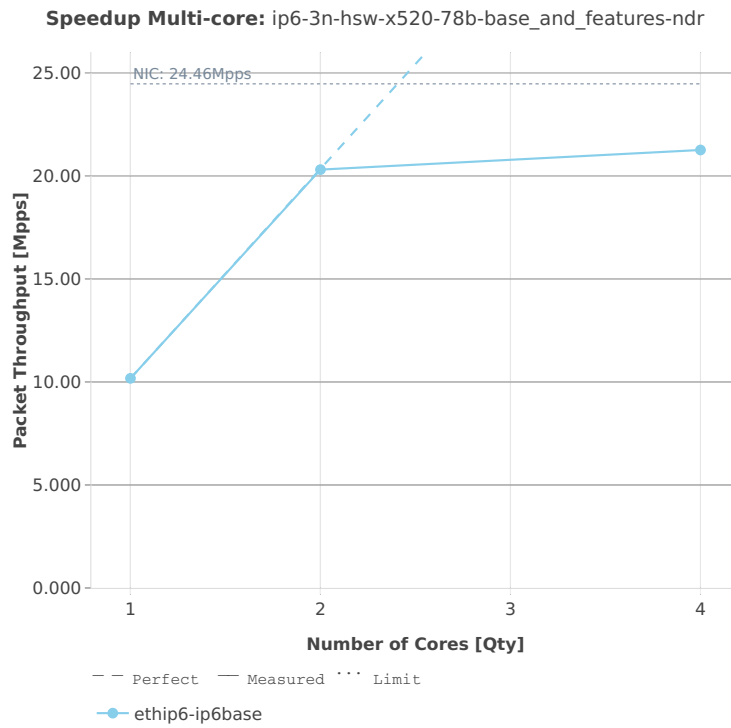

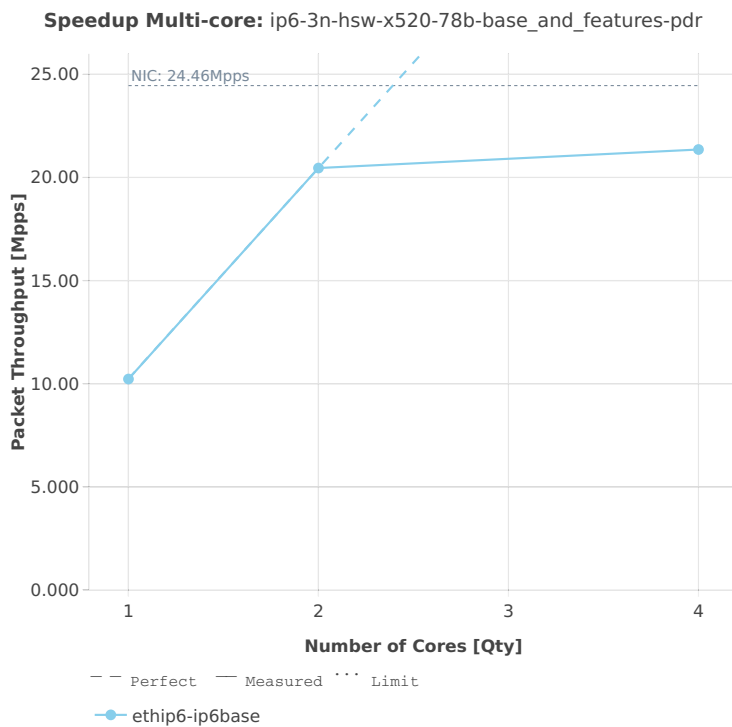

3n-hsw-x710

78b-base\_and\_scale

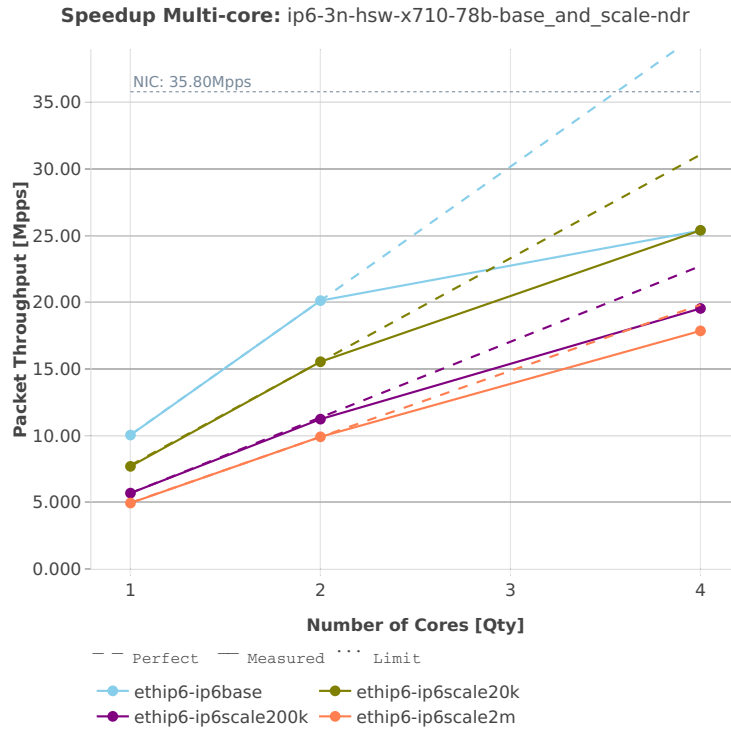

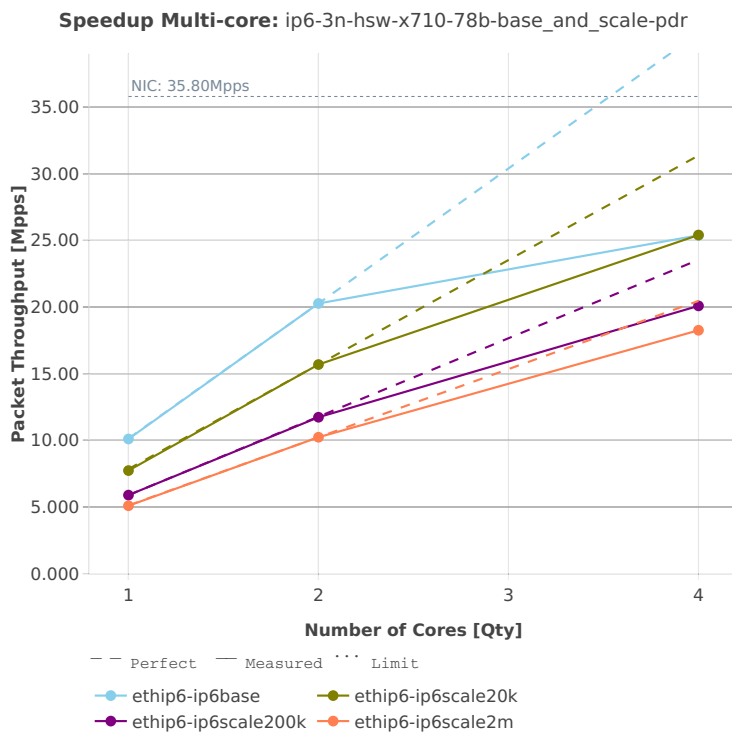

78b-base\_and\_features

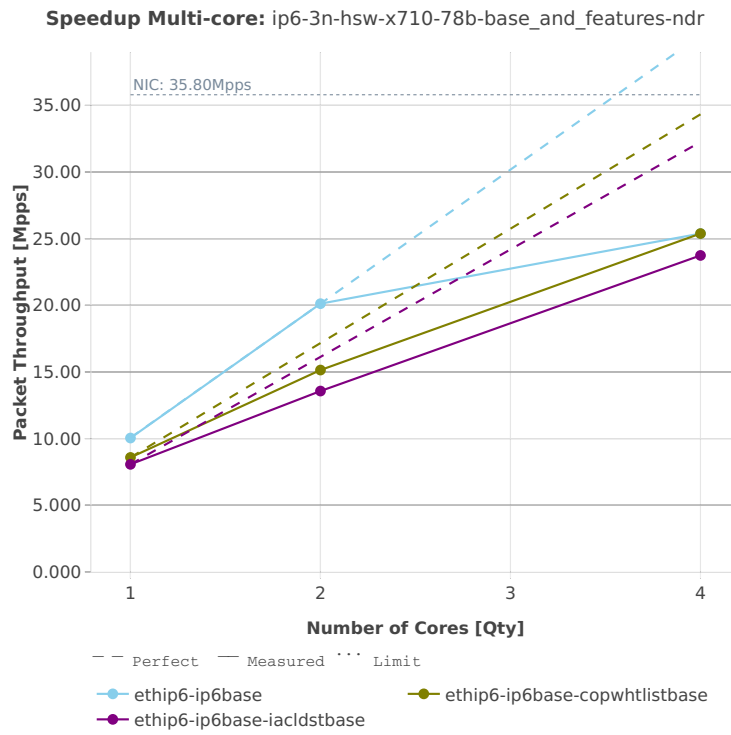

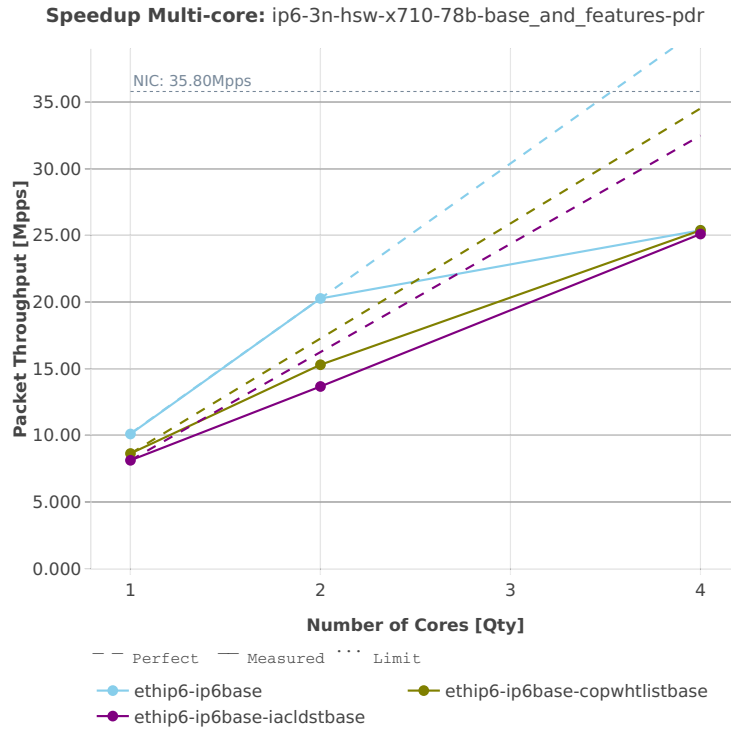

3n-hsw-xl710

78b-base\_and\_scale

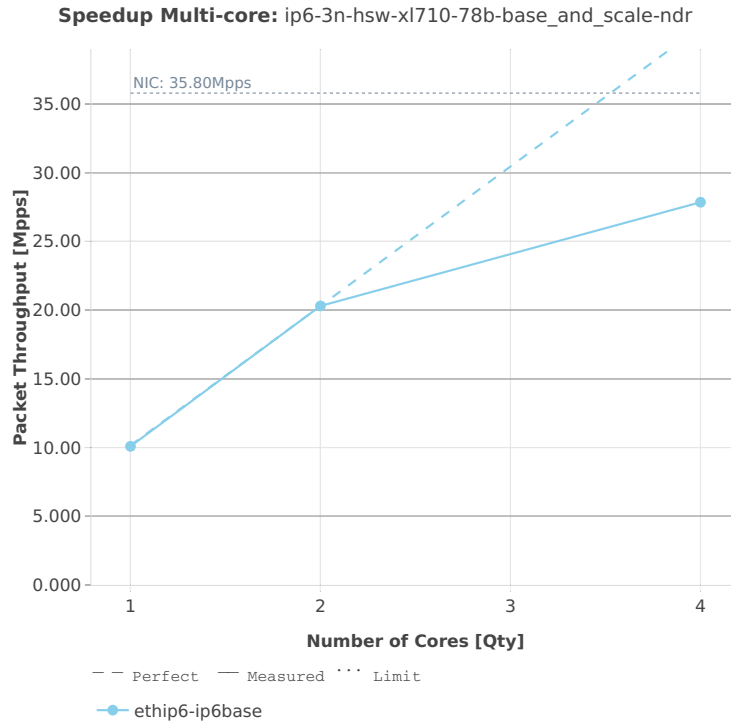



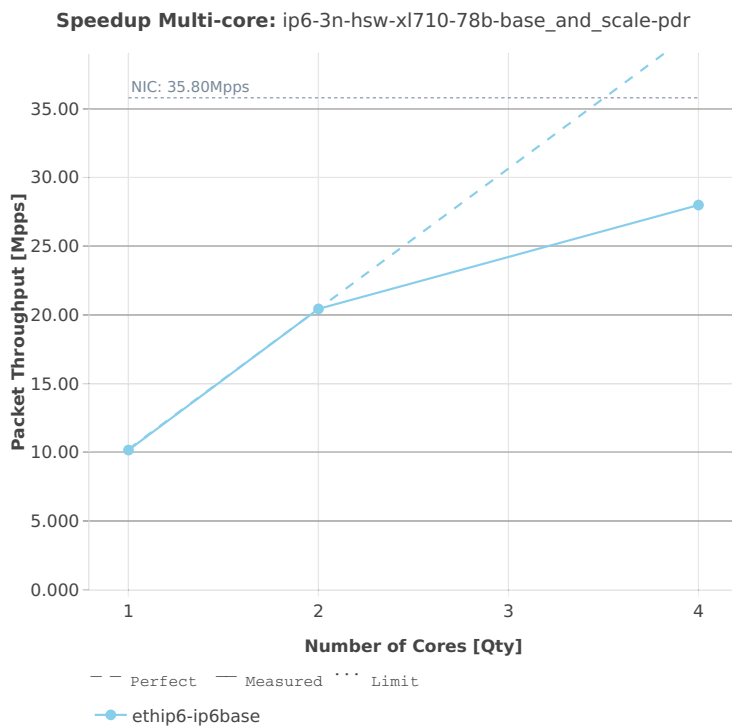

3n-skx-x710

78b-base\_and\_scale

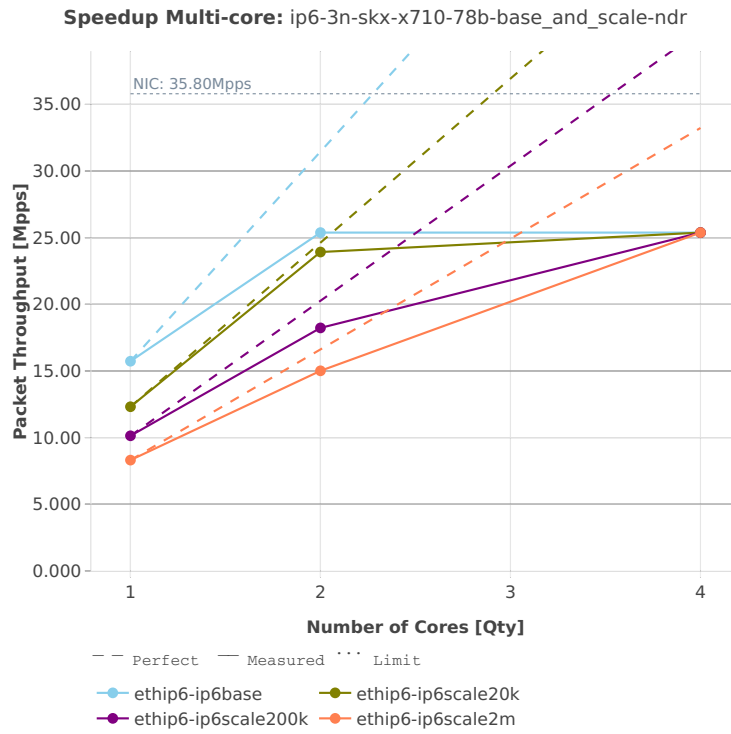

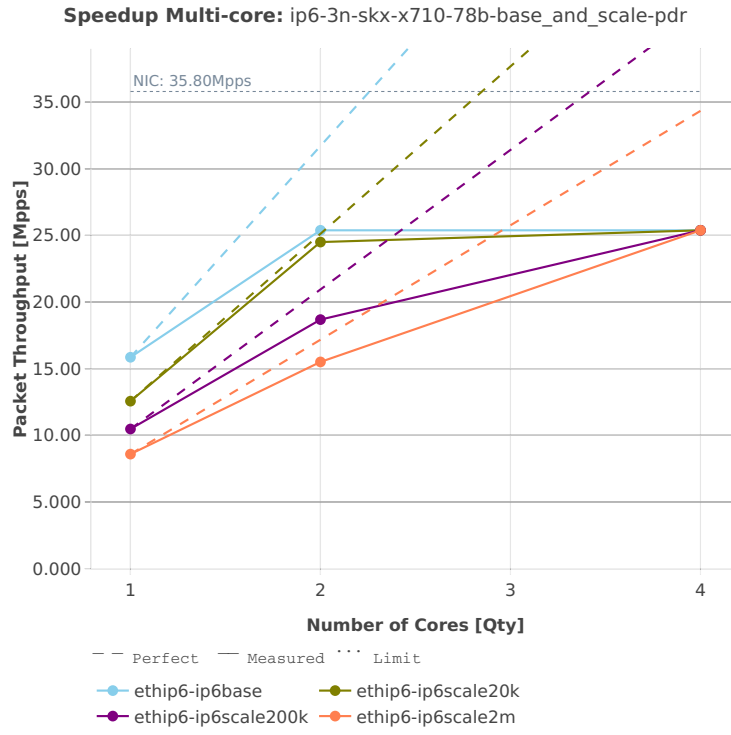

78b-base\_and\_features

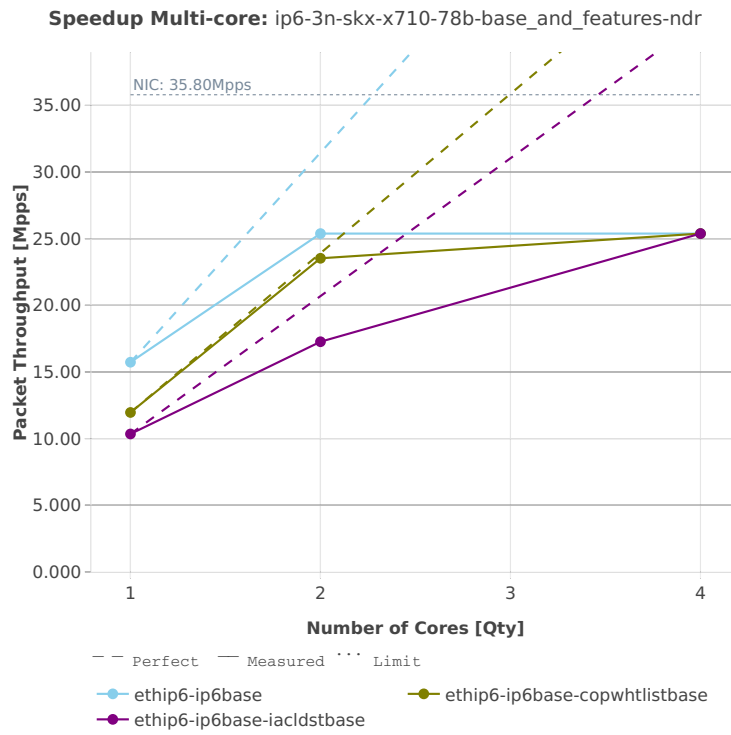

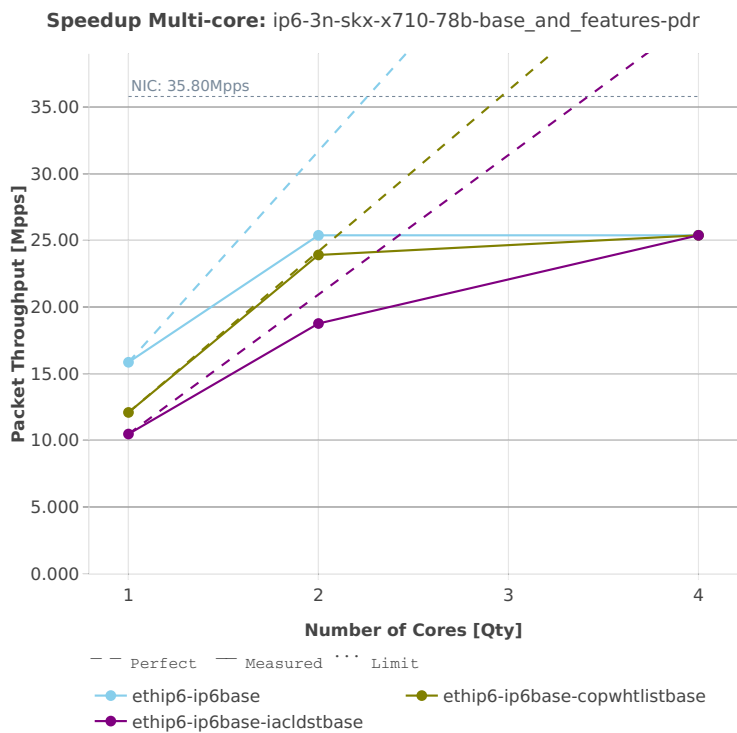

2n-skx-x710

78b-base\_and\_scale

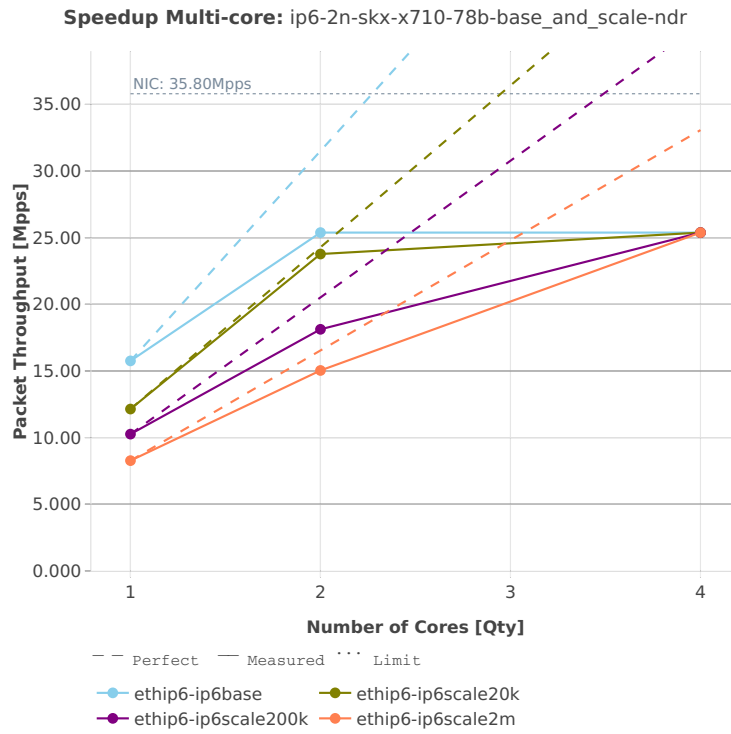

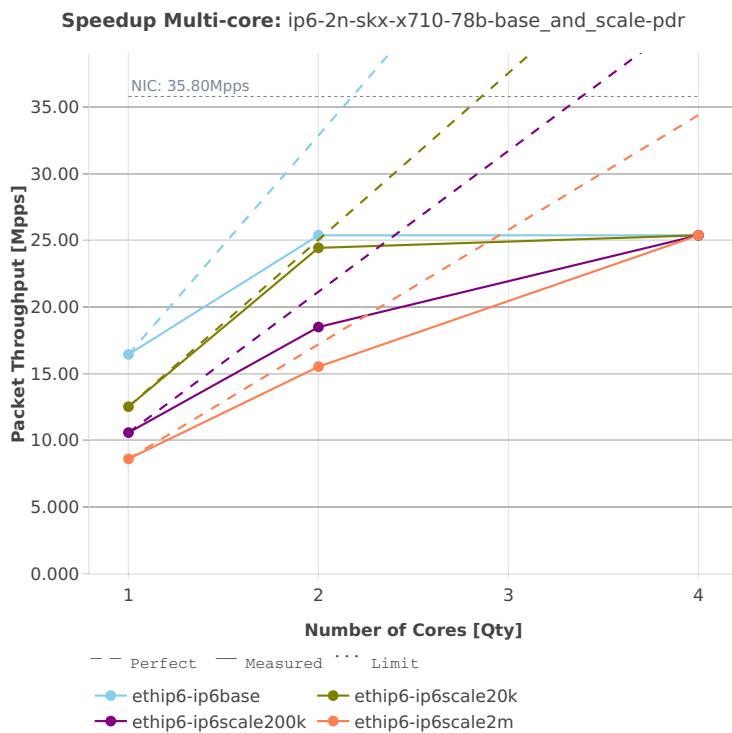

2n-skx-xxv710

78b-base\_and\_scale

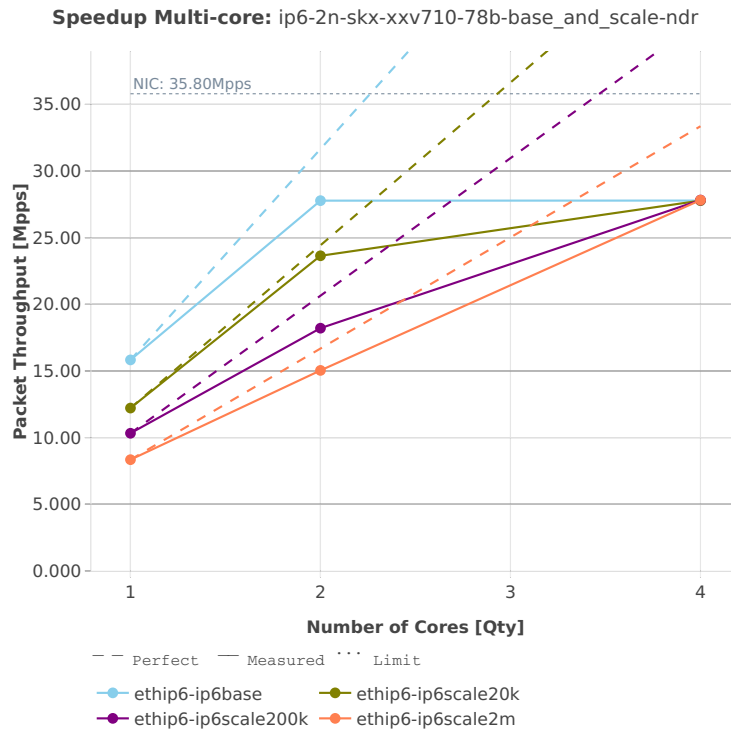



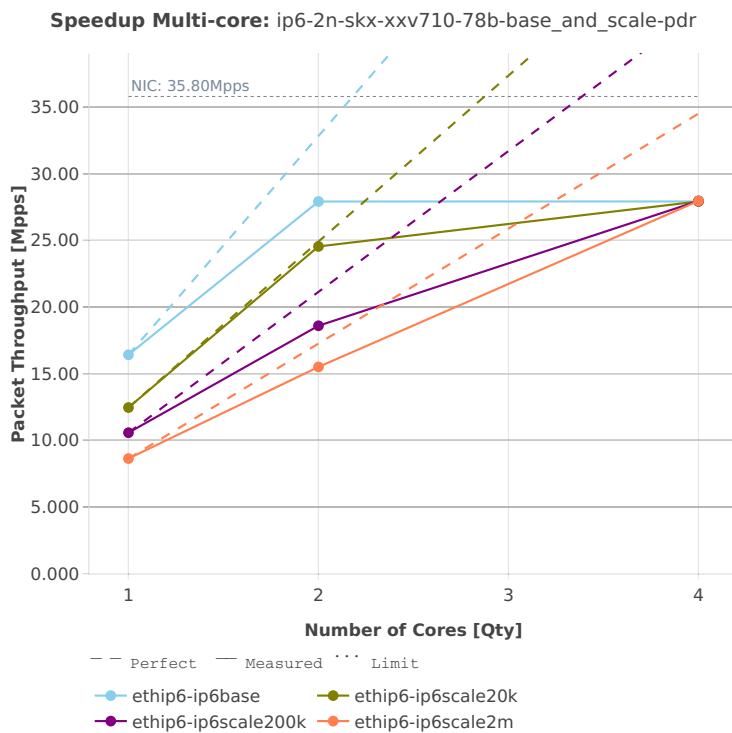

### 2.4.4 SRv6 Routing

Following sections include Throughput Speedup Analysis for VPP multi-core multi-thread configurations with no Hyper-Threading, specifically for tested 2t2c (2threads, 2cores) and 4t4c scenarios. 1t1c throughput results are used as a reference for reported speedup ratio. Input data used for the graphs comes from Phy-to-Phy 78B performance tests with VPP SRv6, including NDR throughput (zero packet loss) and PDR throughput (<0.5% packet loss).

CSIT source code for the test cases used for plots can be found in [CSIT git repository](#)<sup>58</sup>.

---

<sup>58</sup> <https://git.fd.io/csit/tree/tests/vpp/perf/srv6?h=rls1901>

3n-hsw-x520

78b-features

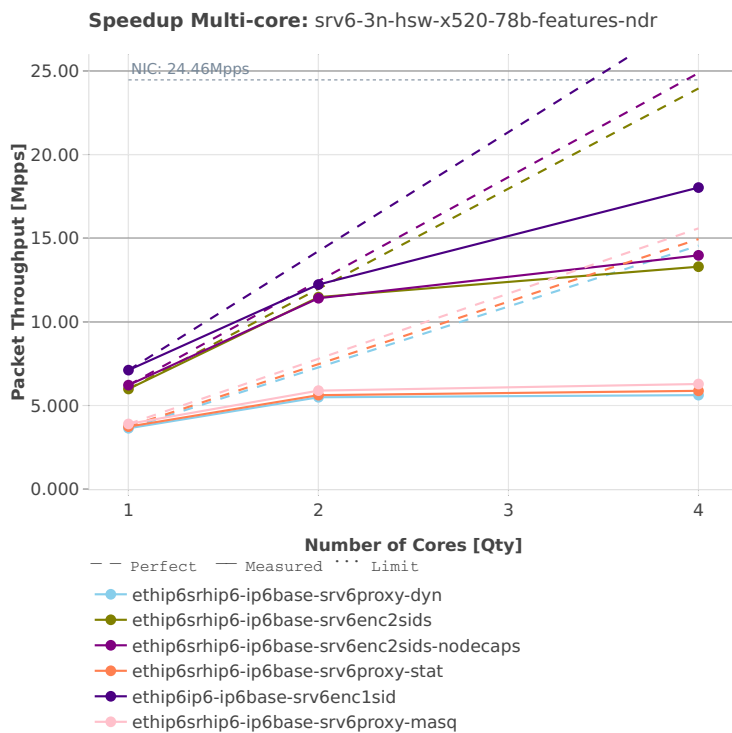

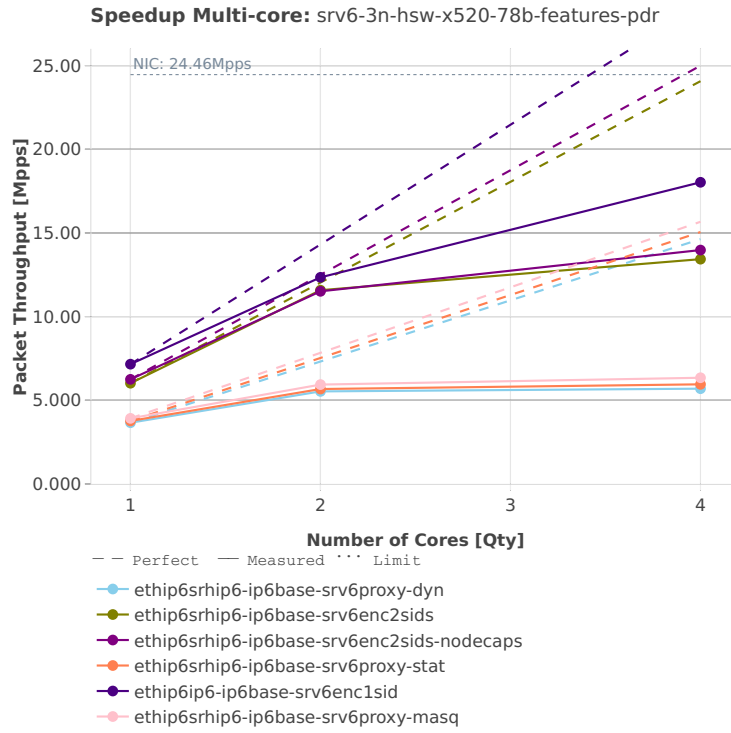

## 2.4.5 IPv4 Tunnels

Following sections include Throughput Speedup Analysis for VPP multi-core multi-thread configurations with no Hyper-Threading, specifically for tested 2t2c (2threads, 2cores) and 4t4c scenarios. 1t1c throughput results are used as a reference for reported speedup ratio. Performance is reported for VPP running in multiple configurations of VPP worker thread(s), a.k.a. VPP data plane thread(s), and their physical CPU core(s) placement.

CSIT source code for the test cases used for plots can be found in [CSIT git repository](#)<sup>59</sup>.

---

<sup>59</sup> [https://git.fd.io/csit/tree/tests/vpp/perf/ip4\\_tunnels?h=rls1901](https://git.fd.io/csit/tree/tests/vpp/perf/ip4_tunnels?h=rls1901)

3n-hsw-x520

64b-base\_and\_features

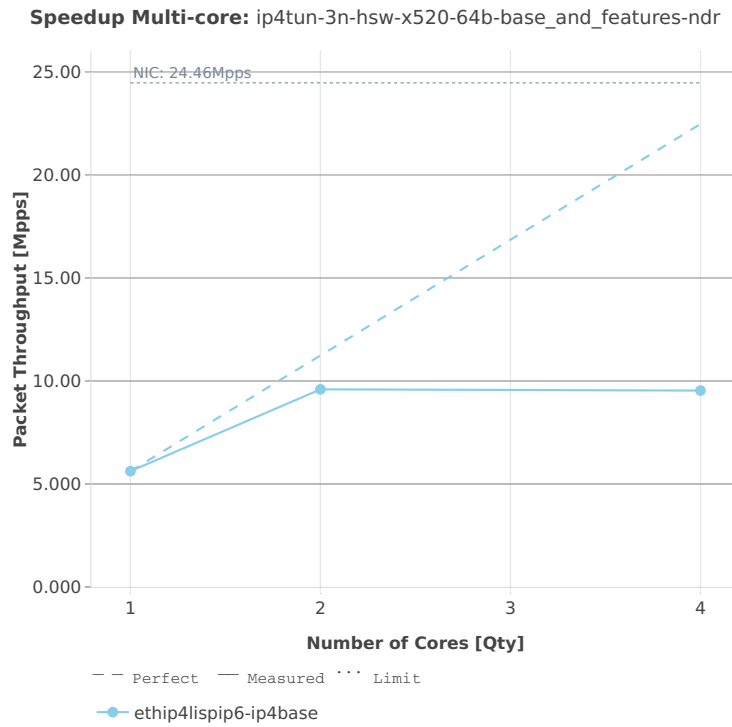

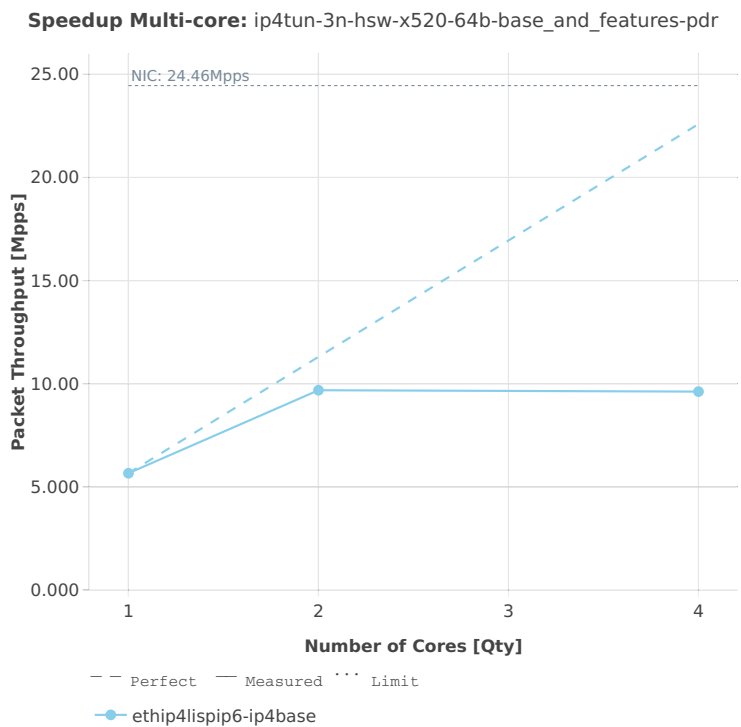

3n-hsw-x710

64b-base\_and\_scale

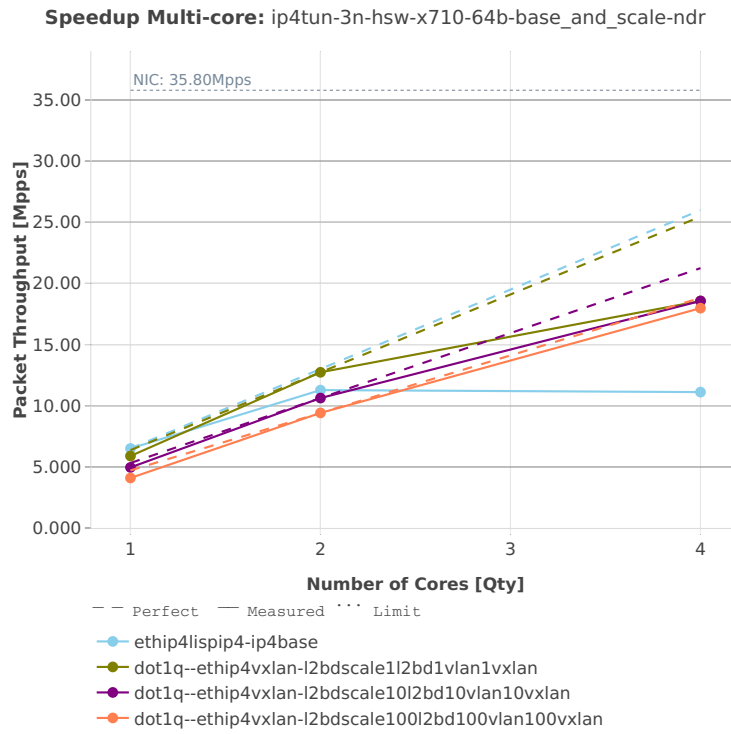



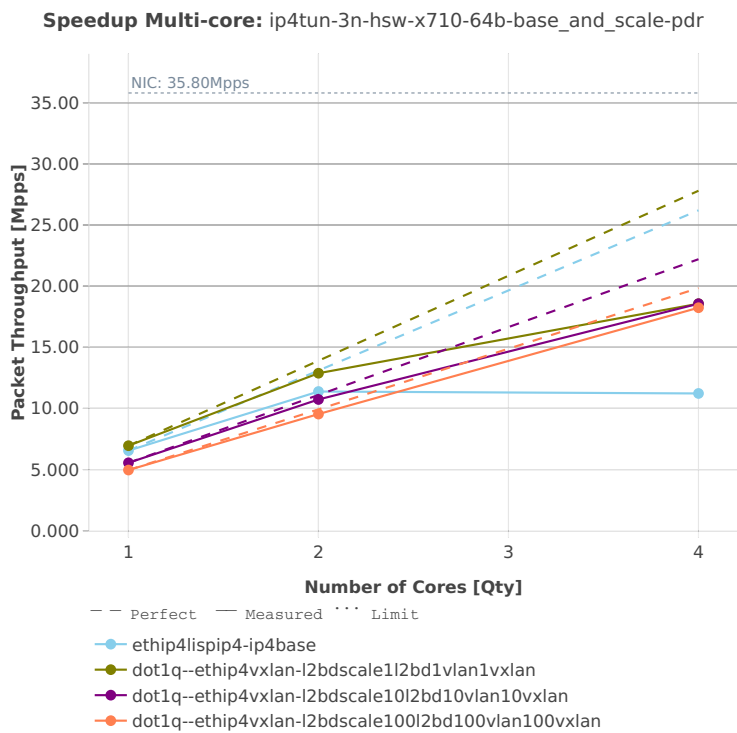

64b-base\_and\_features

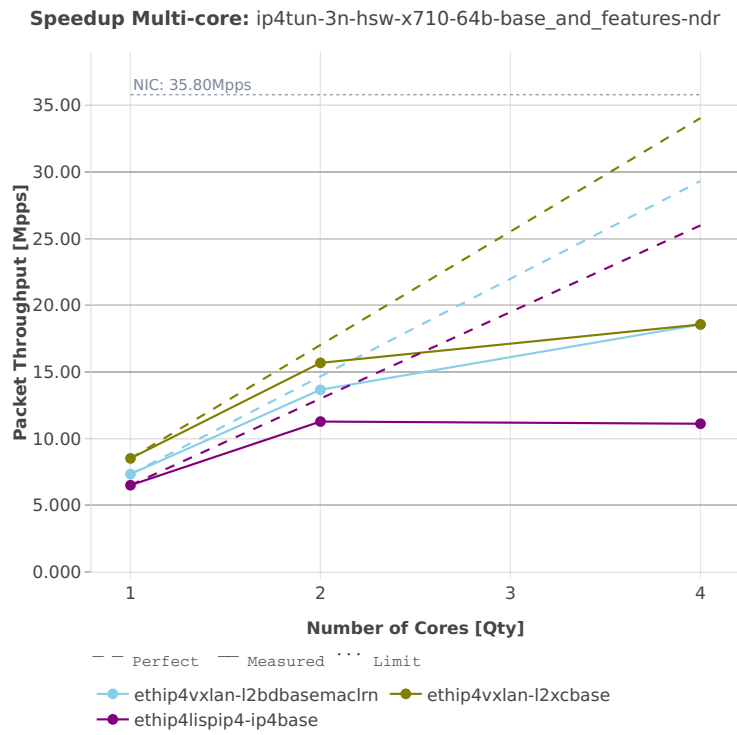

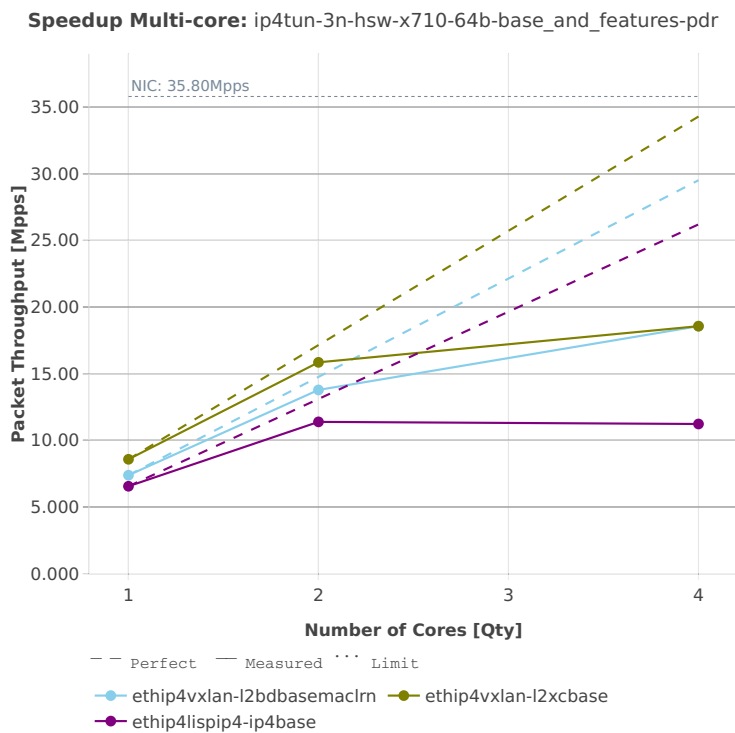

3n-skx-x710

64b-base\_and\_scale

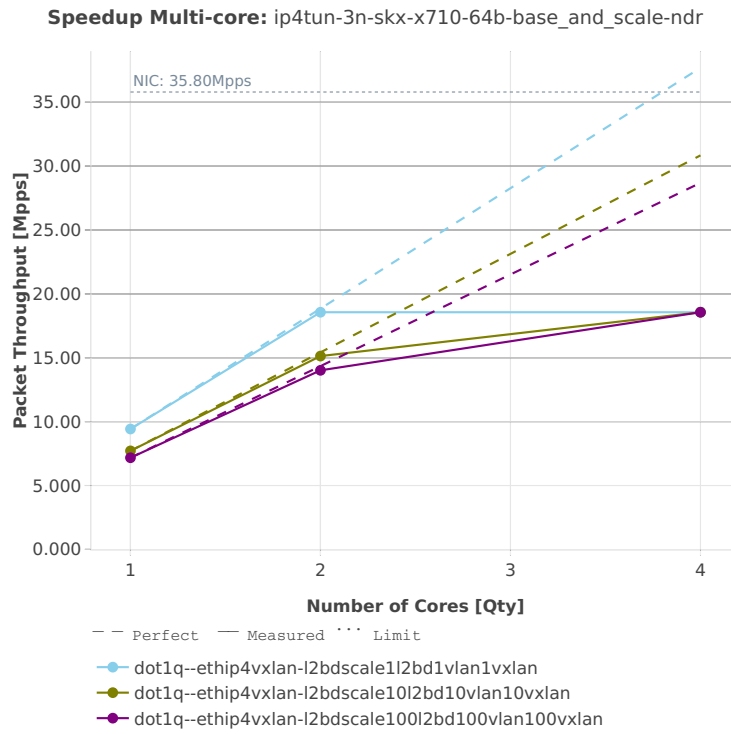

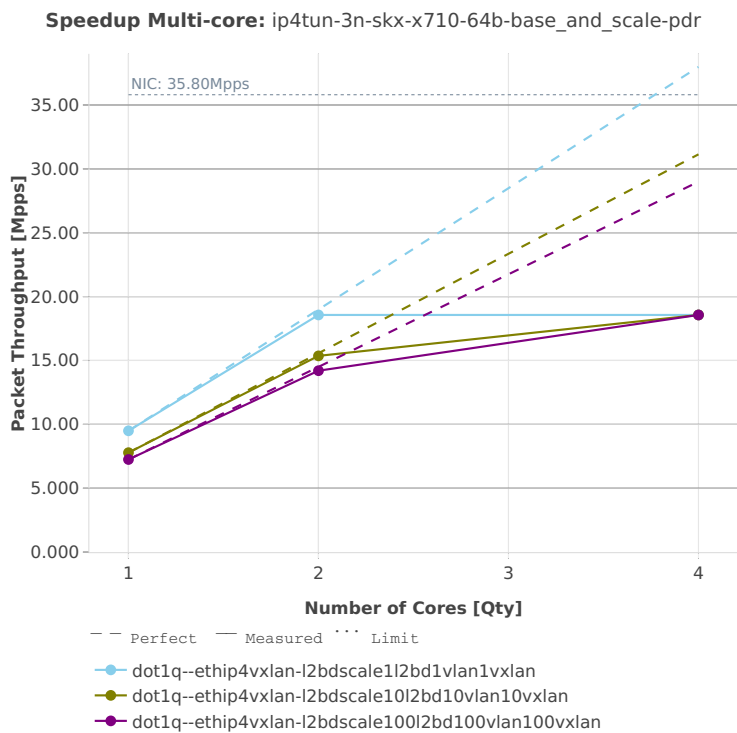

64b-base\_and\_features

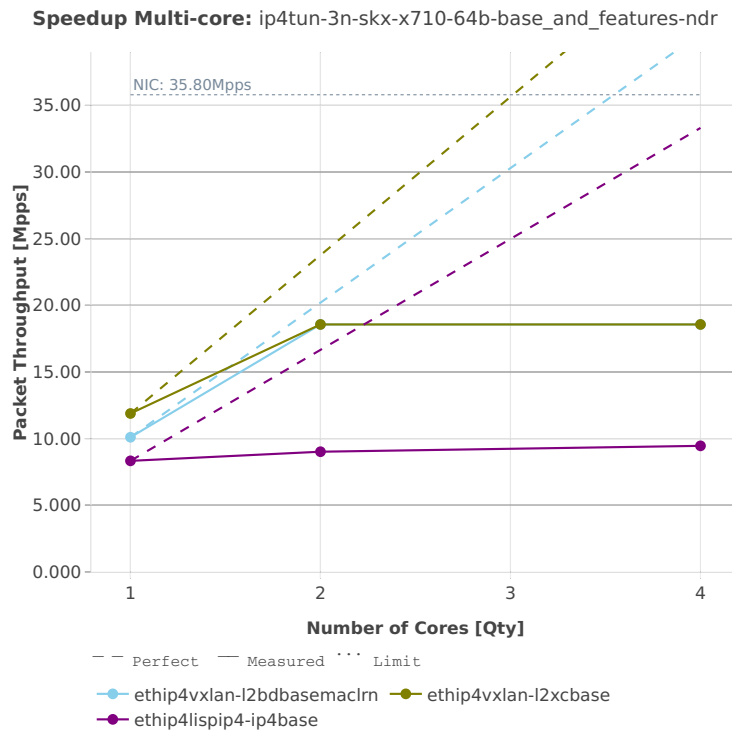

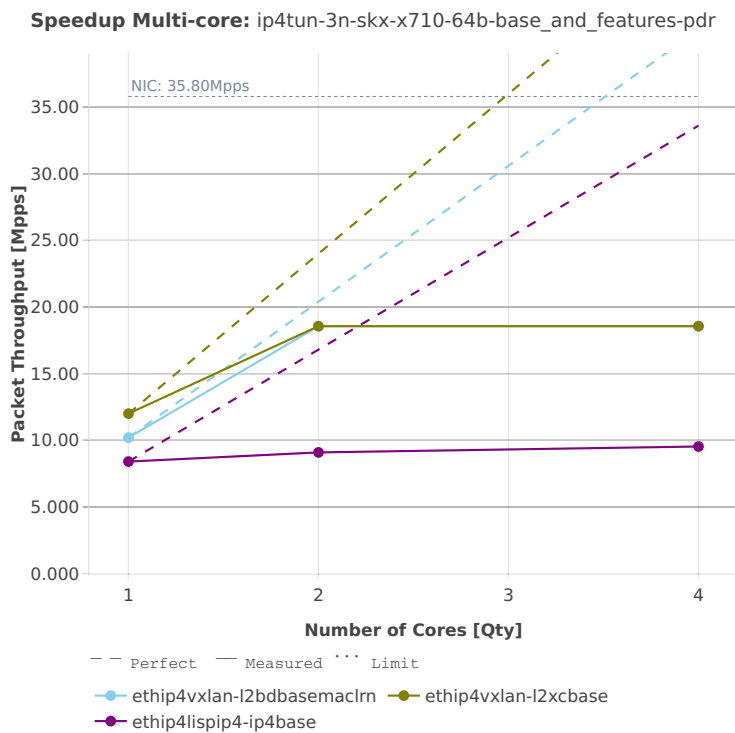

## 2.4.6 IPv6 Tunnels

Following sections include Throughput Speedup Analysis for VPP multi-core multi-thread configurations with no Hyper-Threading, specifically for tested 2t2c (2threads, 2cores) and 4t4c scenarios. 1t1c throughput results are used as a reference for reported speedup ratio. Performance is reported for VPP running in multiple configurations of VPP worker thread(s), a.k.a. VPP data plane thread(s), and their physical CPU core(s) placement.

CSIT source code for the test cases used for plots can be found in [CSIT git repository](#)<sup>60</sup>.

---

<sup>60</sup> [https://git.fd.io/csit/tree/tests/vpp/perf/ip6\\_tunnels?h=rls1901](https://git.fd.io/csit/tree/tests/vpp/perf/ip6_tunnels?h=rls1901)



3n-hsw-x520

78b-base\_and\_scale

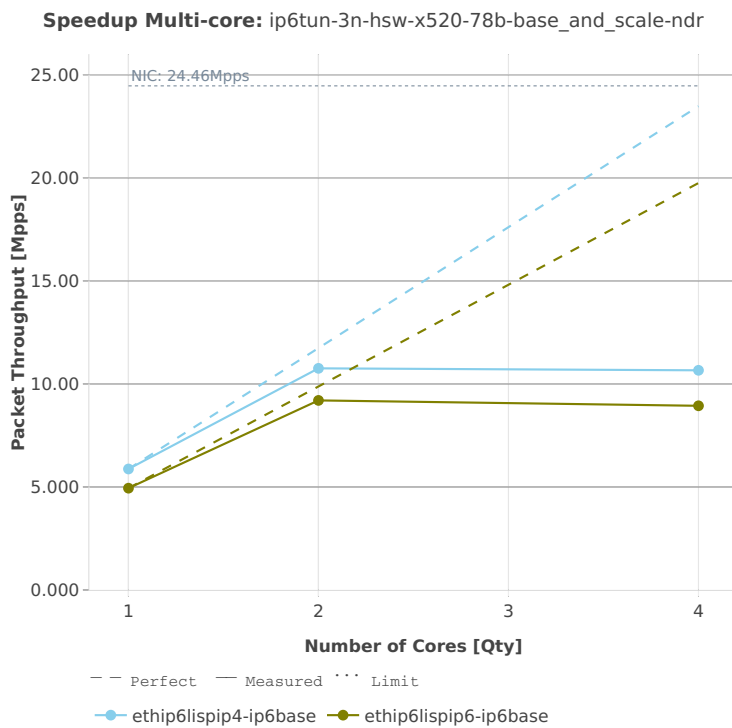

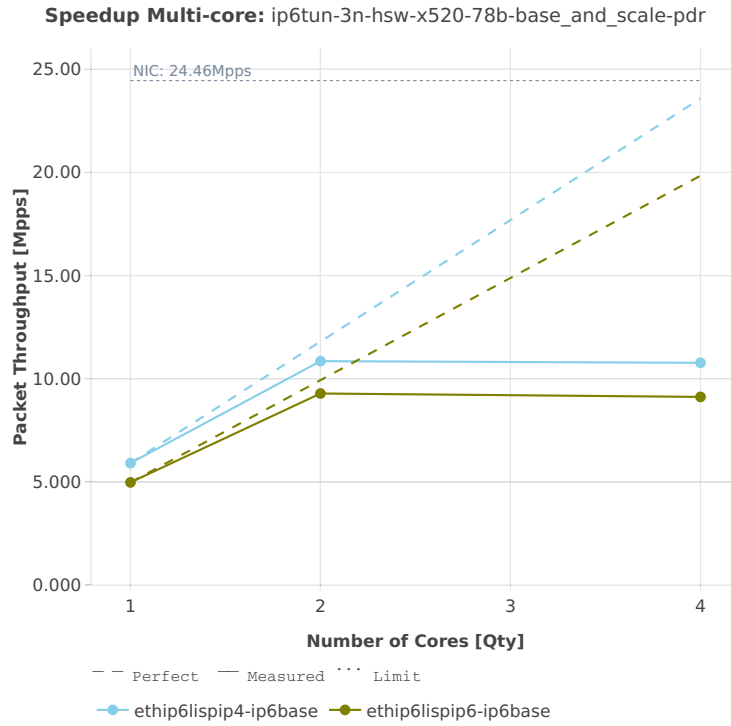

### 2.4.7 KVM VMs vhost-user

Following sections include Throughput Speedup Analysis for VPP multi-core multi-thread configurations with no Hyper-Threading, specifically for tested 2t2c (2threads, 2cores) and 4t4c scenarios. 1t1c throughput results are used as a reference for reported speedup ratio. Input data used for the graphs comes from Phy-to-Phy 64B performance tests with VM vhost-user, including NDR throughput (zero packet loss) and PDR throughput (<0.5% packet loss).

CSIT source code for the test cases used for plots can be found in [CSIT git repository](#)<sup>61</sup>.

---

<sup>61</sup> [https://git.fd.io/csit/tree/tests/vpp/perf/vm\\_vhost?h=rls1901](https://git.fd.io/csit/tree/tests/vpp/perf/vm_vhost?h=rls1901)

3n-hsw-x520

64b-base-l2sw

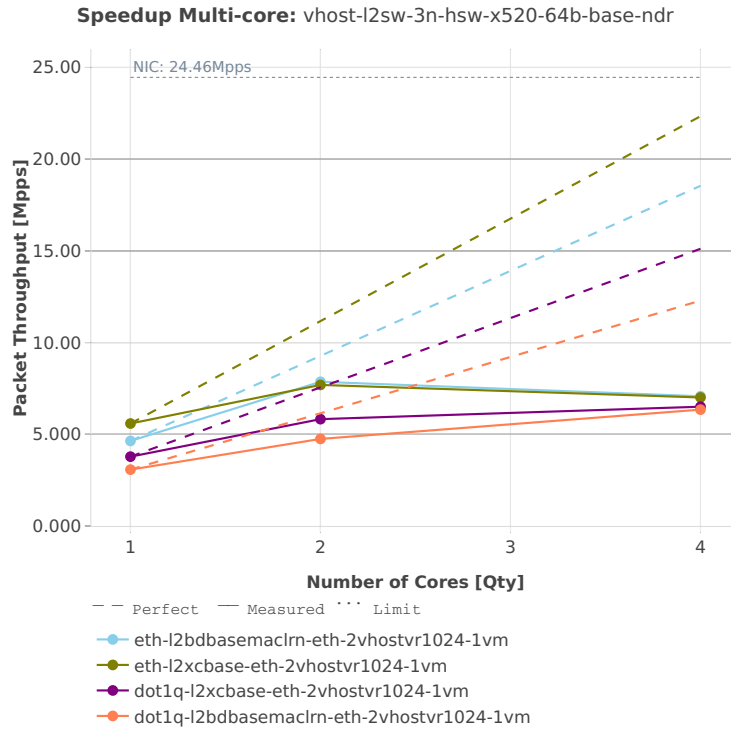

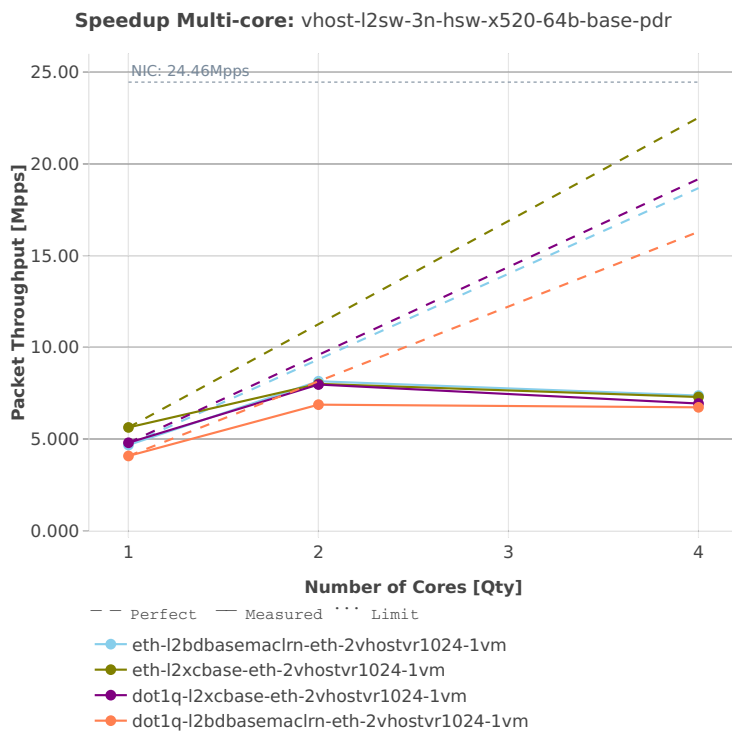

64b-base\_and\_scale-l2sw

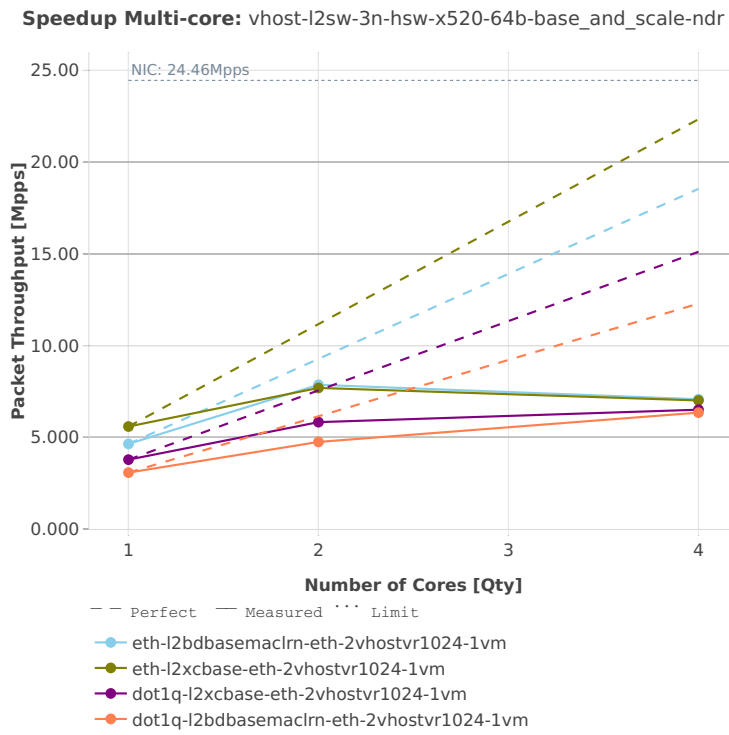

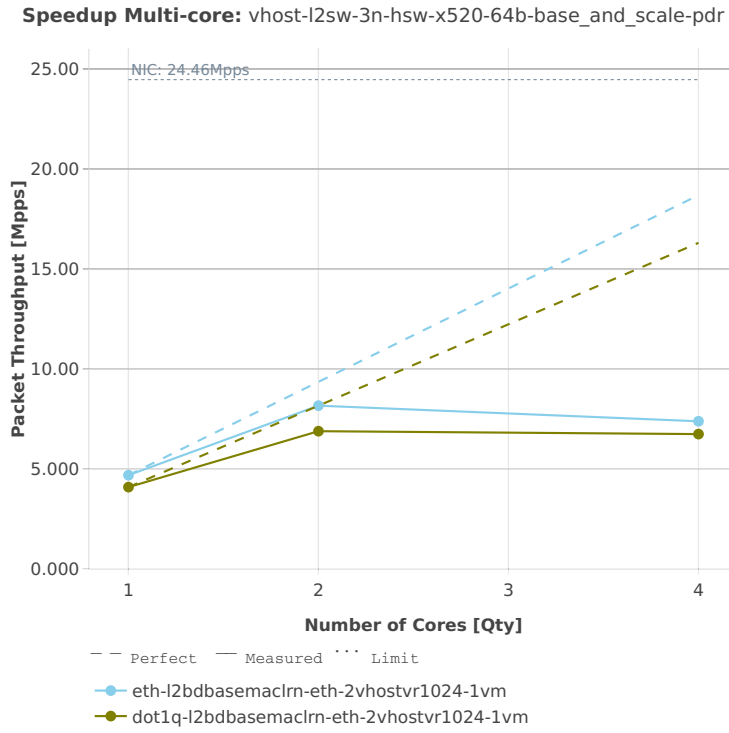

64b-base-vm-l2sw

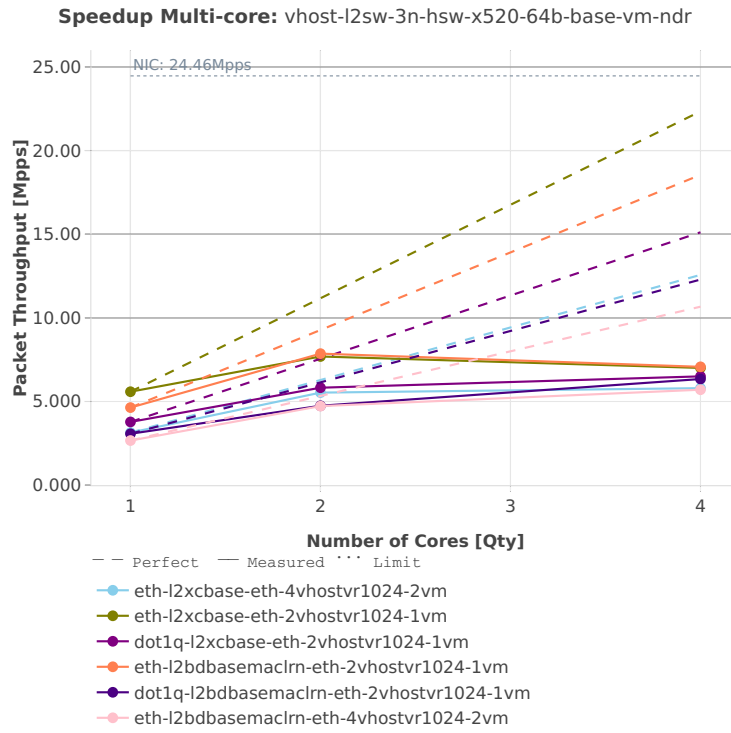



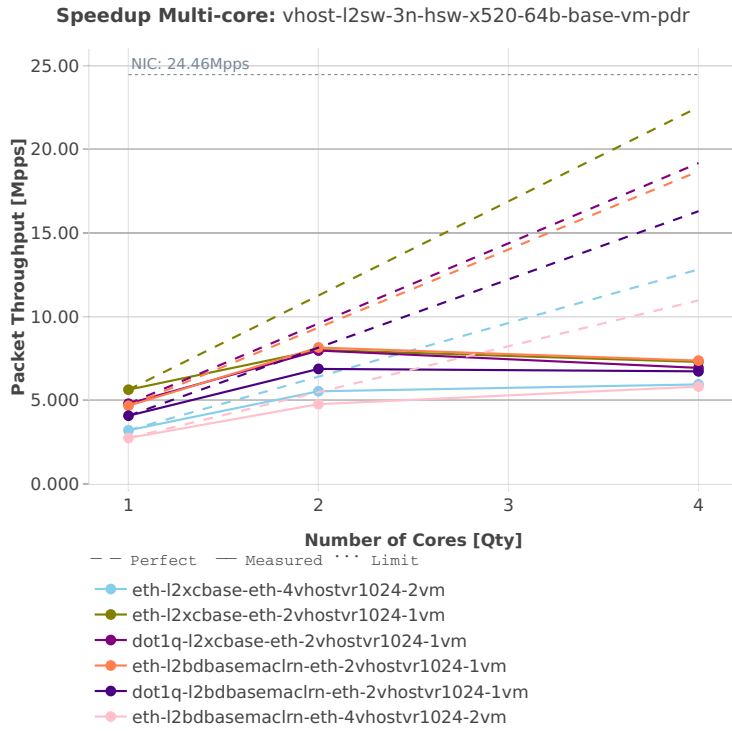

64b-base\_and\_scale-ip4

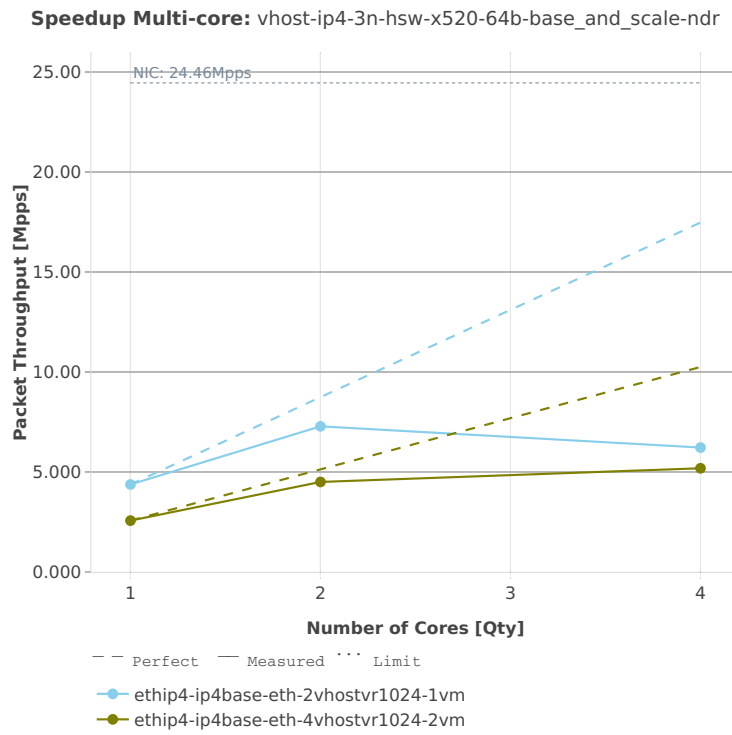

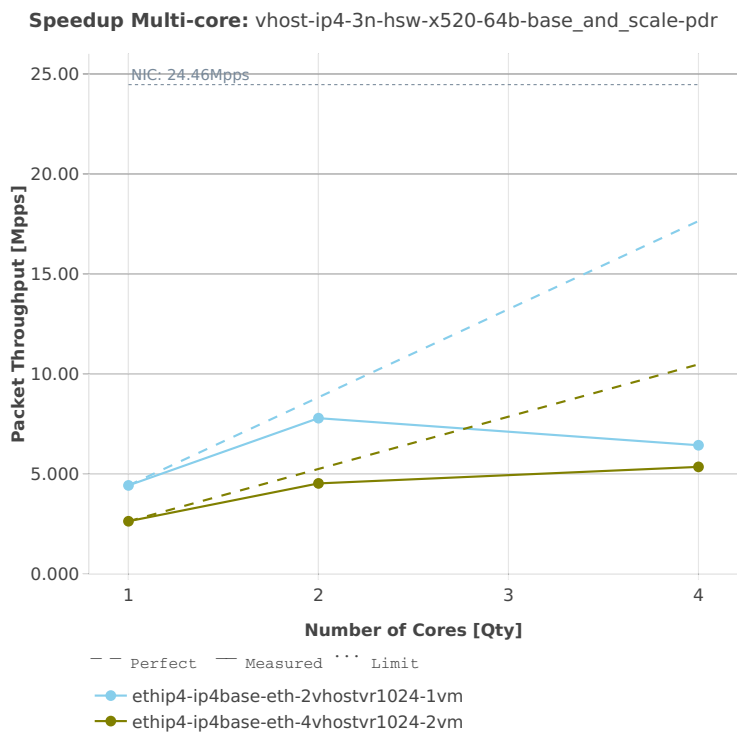

3n-hsw-x710

64b-base-l2sw

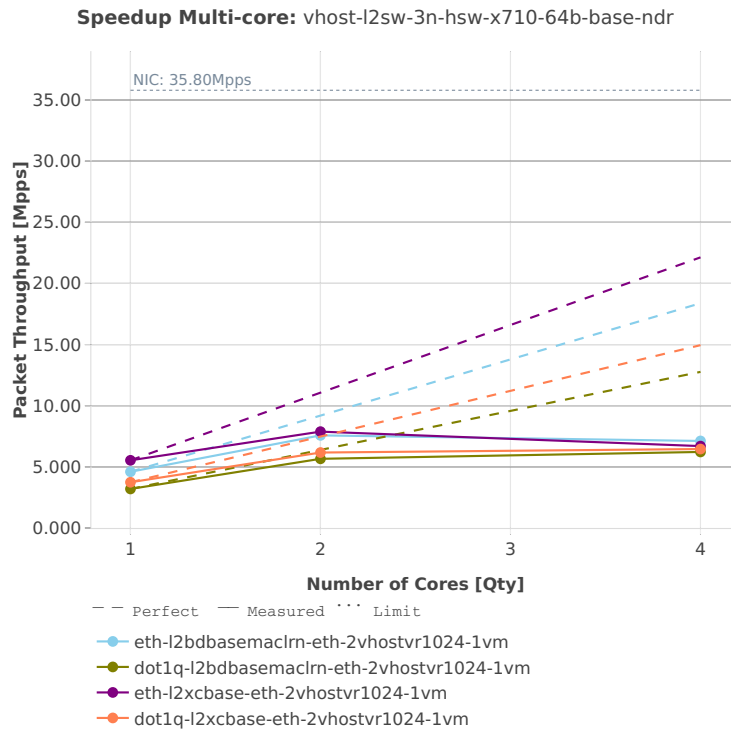

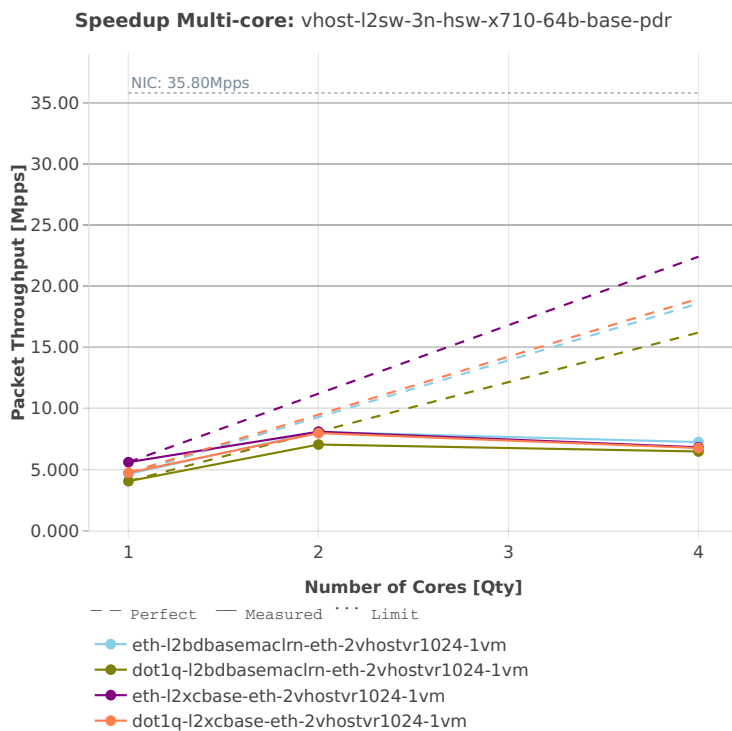

64b-base\_and\_scale-l2sw

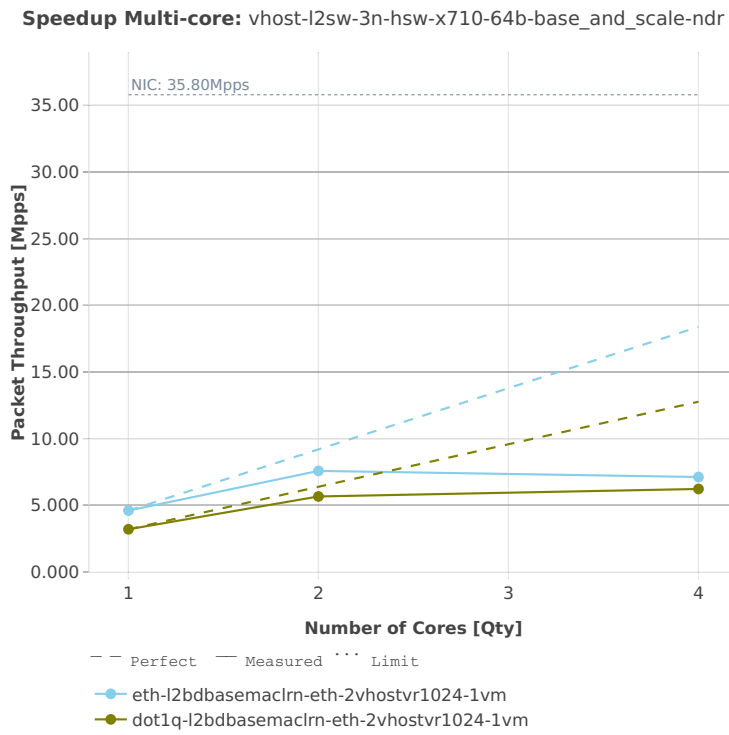

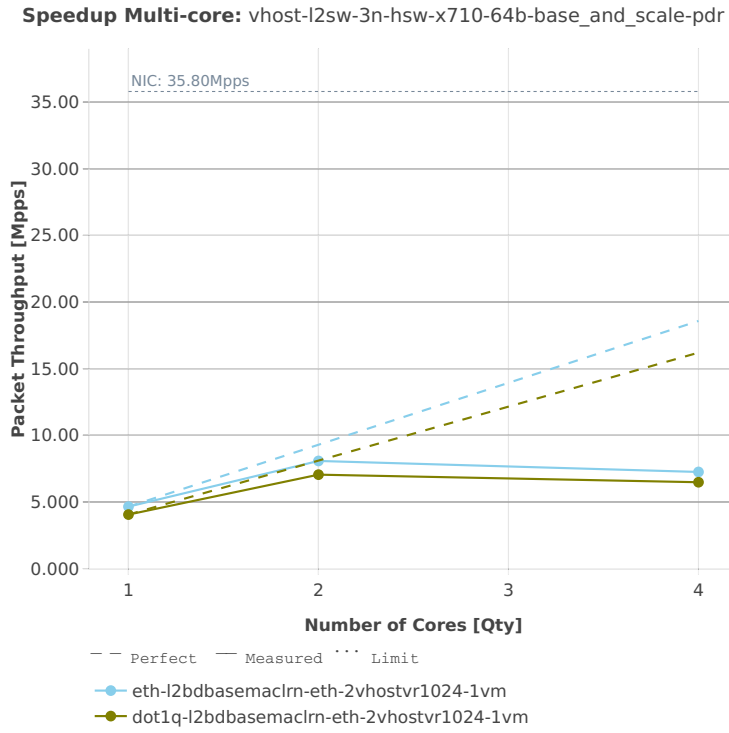

64b-base-vm-l2sw

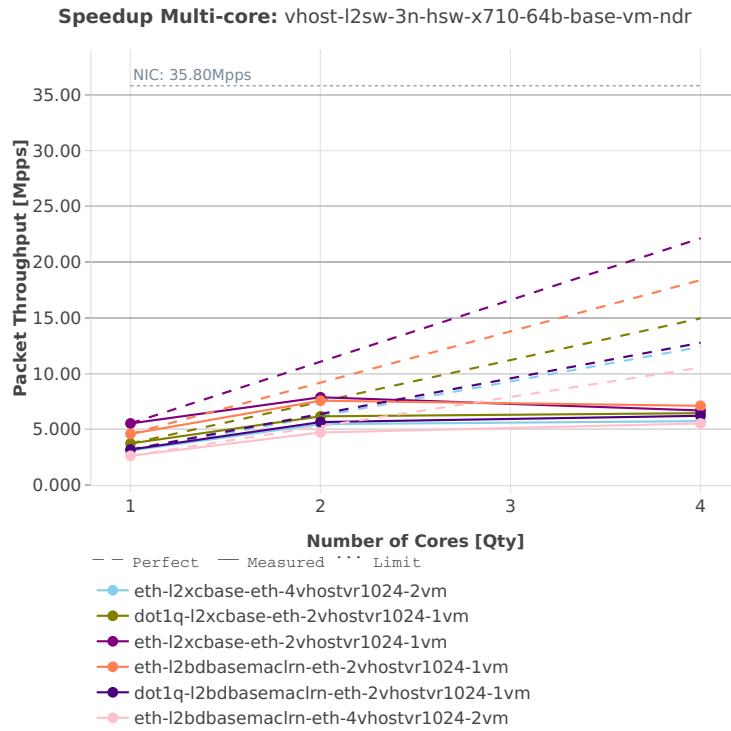



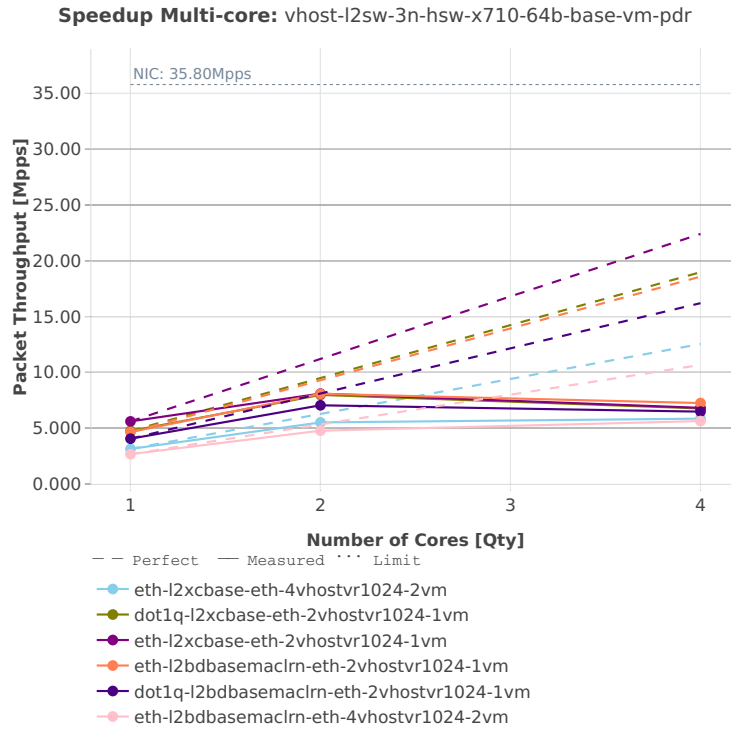

64b-base\_and\_scale-ip4

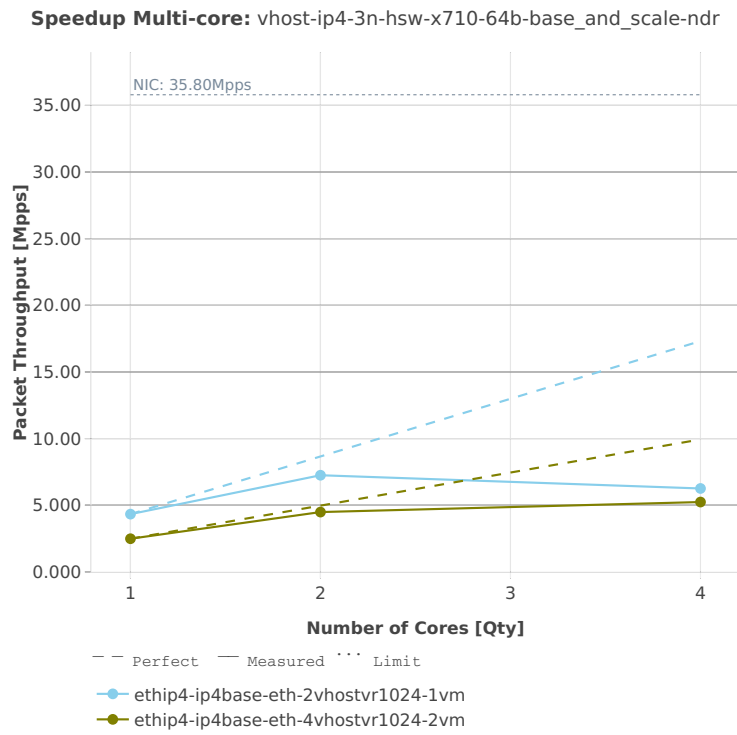

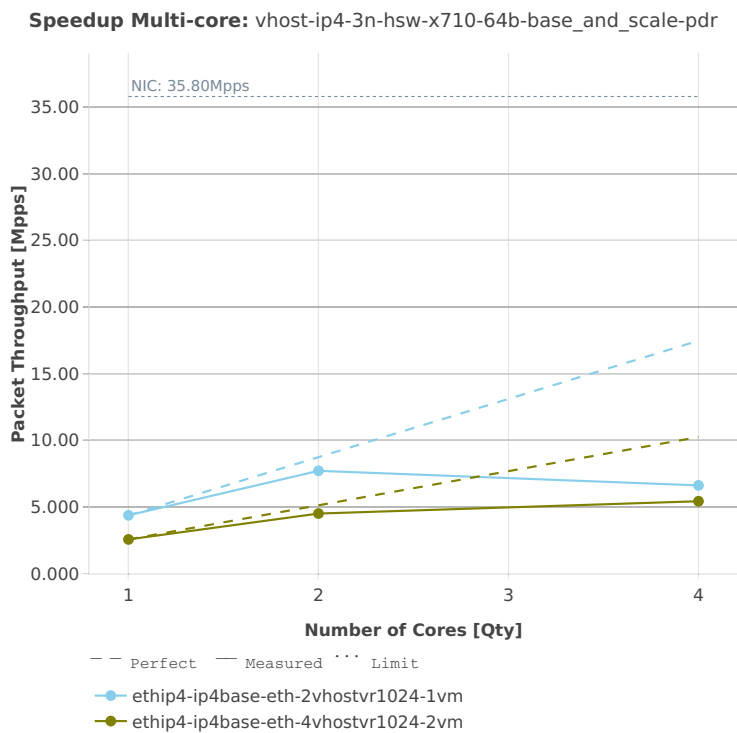

3n-skx-x710

64b-base-l2sw



64b-base\_and\_scale-l2sw



64b-base-vm-l2sw





64b-base\_and\_scale-ip4



2n-skx-x710

64b-base-l2sw

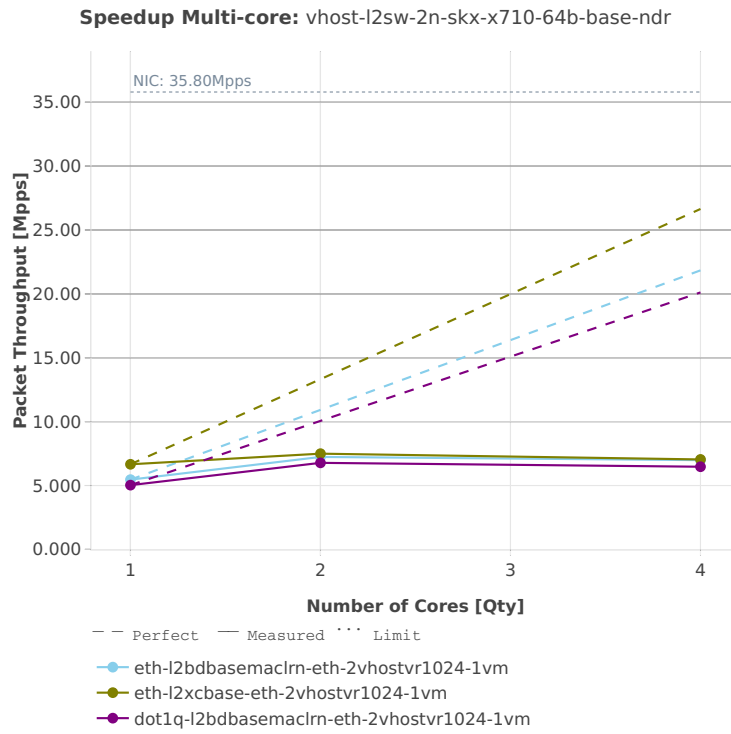

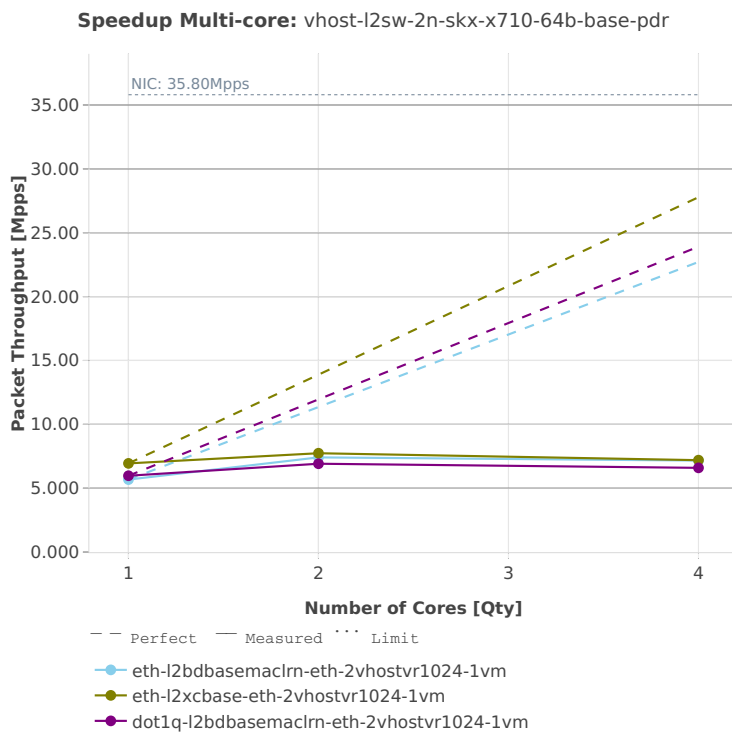

64b-base\_and\_scale-l2sw

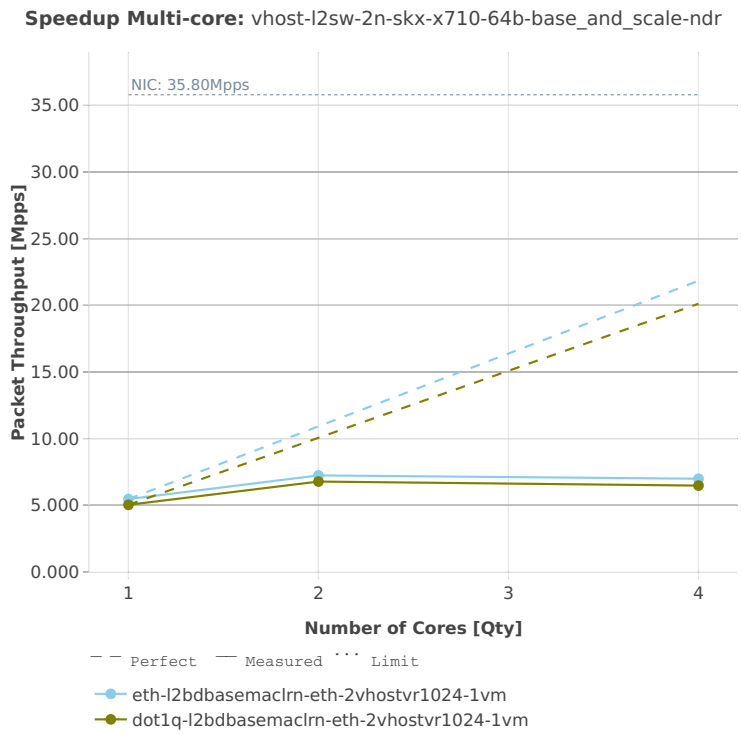



64b-base-vm-l2sw

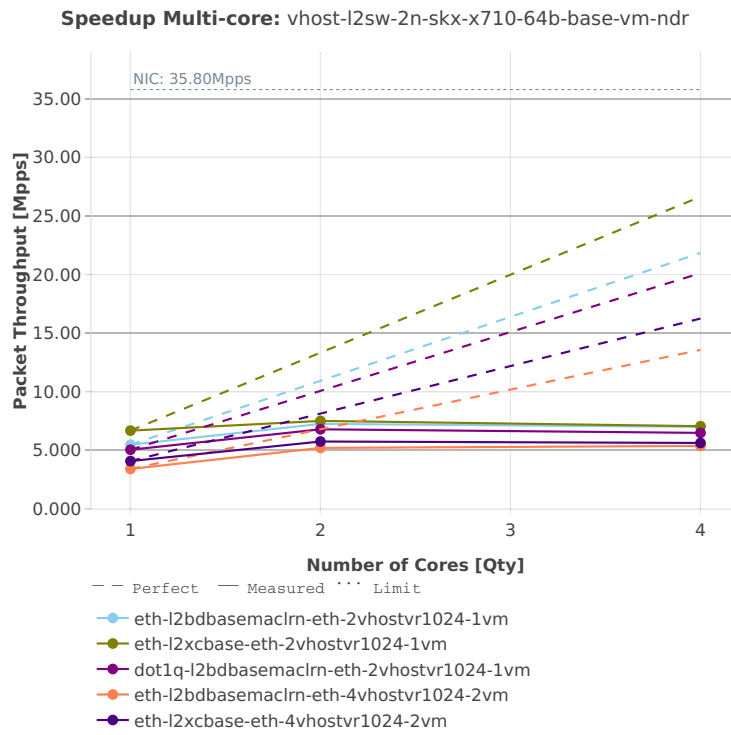



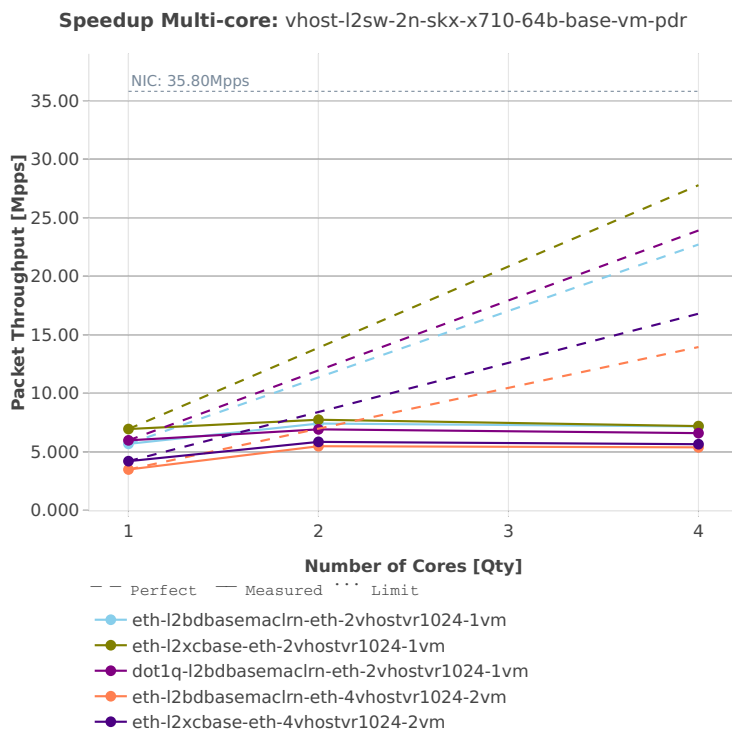

64b-base\_and\_scale-ip4

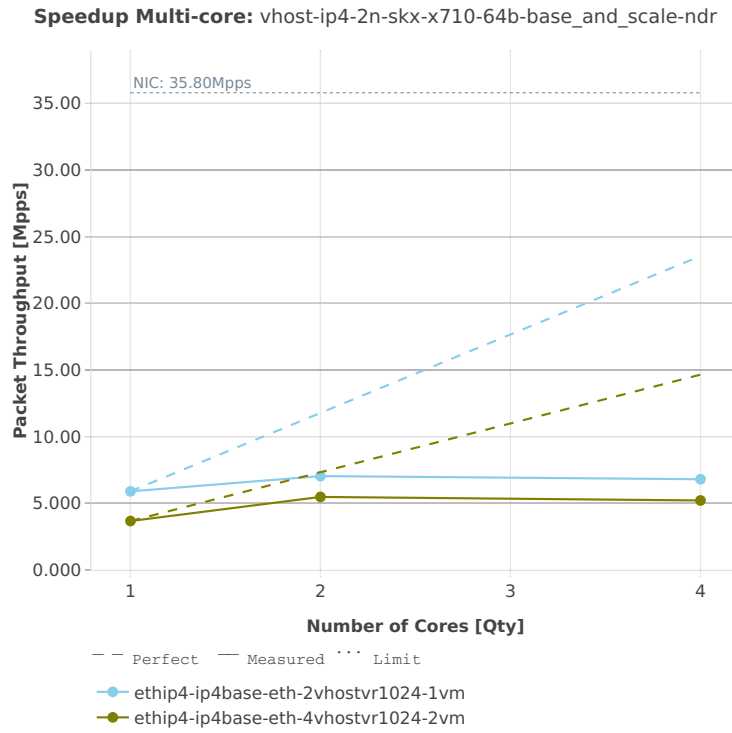

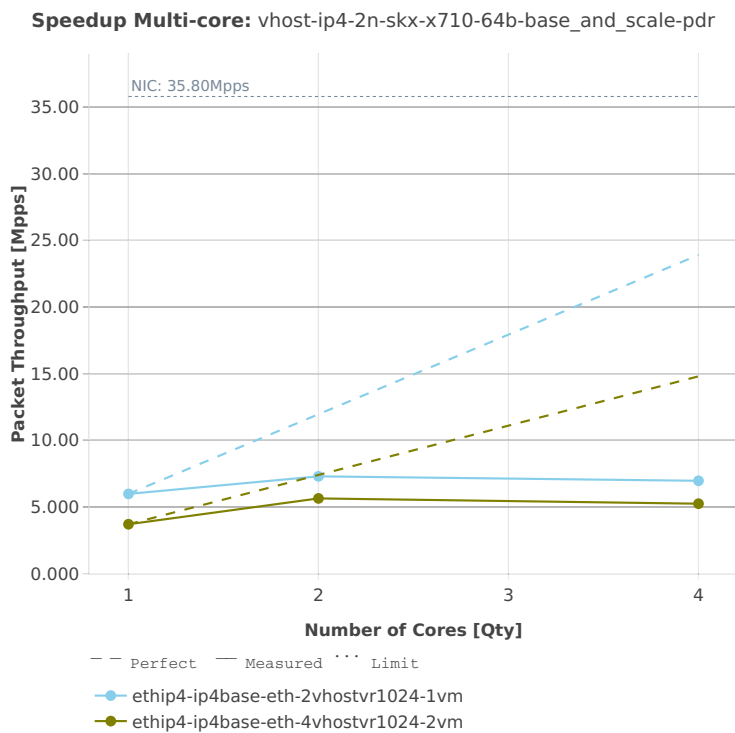

### 2.4.8 LXC/DRC Container Memif

Following sections include Throughput Speedup Analysis for VPP multi-core multi-thread configurations with no Hyper-Threading, specifically for tested 2t2c (2threads, 2cores) and 4t4c scenarios. 1t1c throughput results are used as a reference for reported speedup ratio. Performance is reported for VPP running in multiple configurations of VPP worker thread(s), a.k.a. VPP data plane thread(s), and their physical CPU core(s) placement.

CSIT source code for the test cases used for plots can be found in [CSIT git repository](#)<sup>62</sup>.

---

<sup>62</sup> [https://git.fd.io/csit/tree/tests/vpp/perf/container\\_memif?h=rls1901](https://git.fd.io/csit/tree/tests/vpp/perf/container_memif?h=rls1901)

3n-hsw-x520

64b-base\_and\_scale

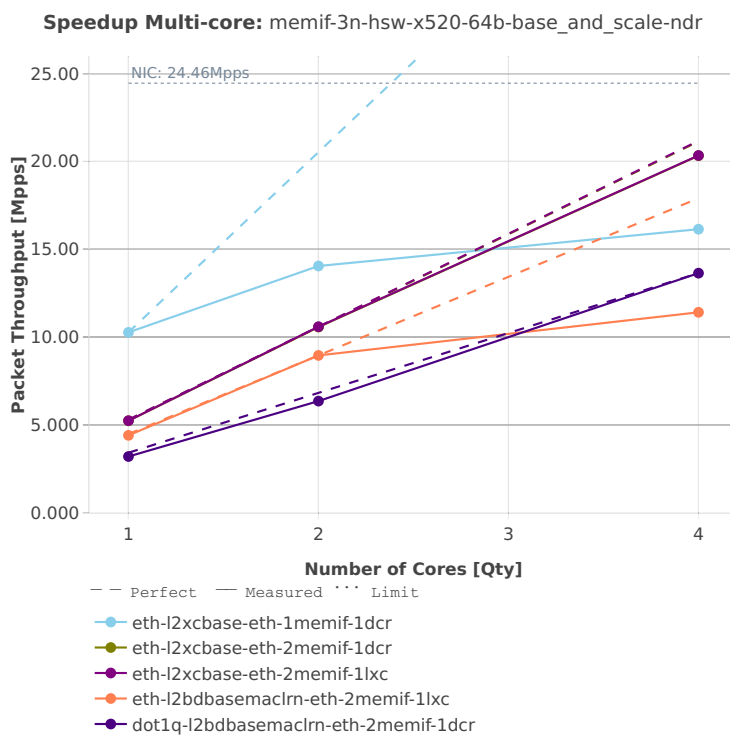

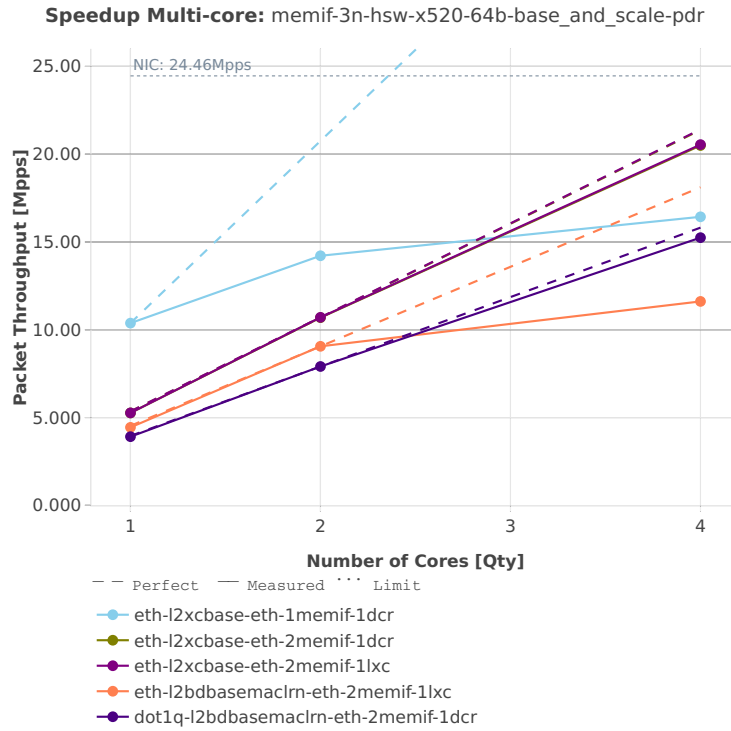

3n-hsw-x710

64b-base\_and\_scale

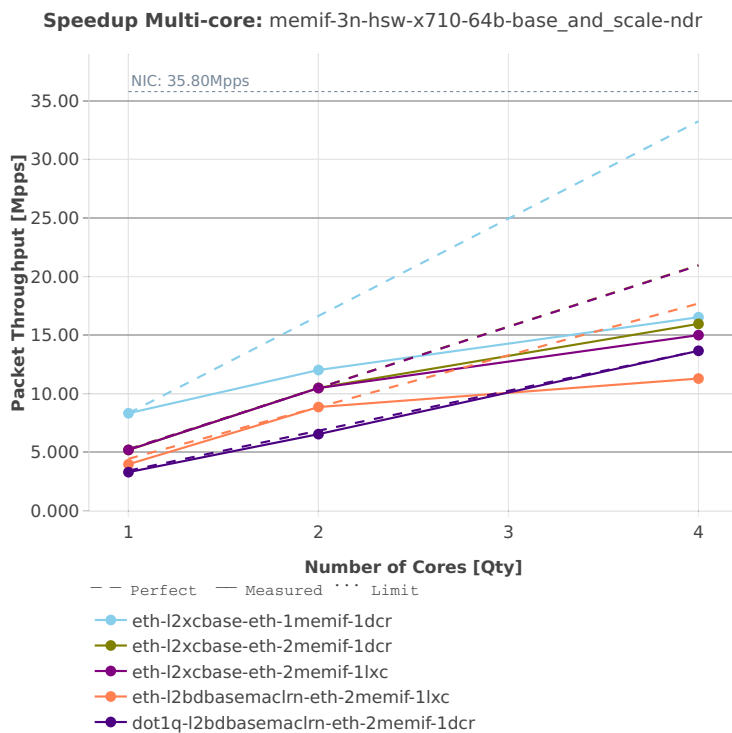

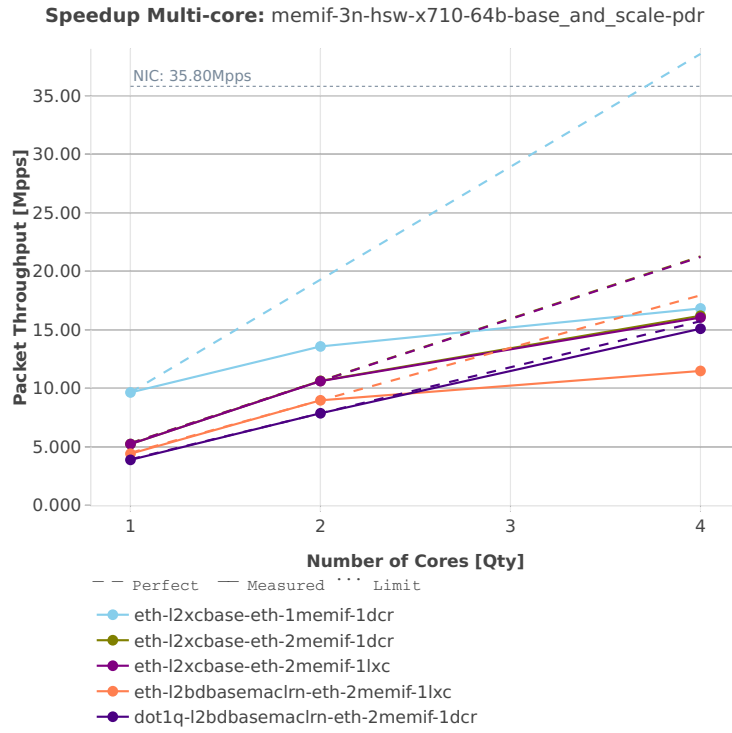



3n-hsw-xl710

64b-base\_and\_scale

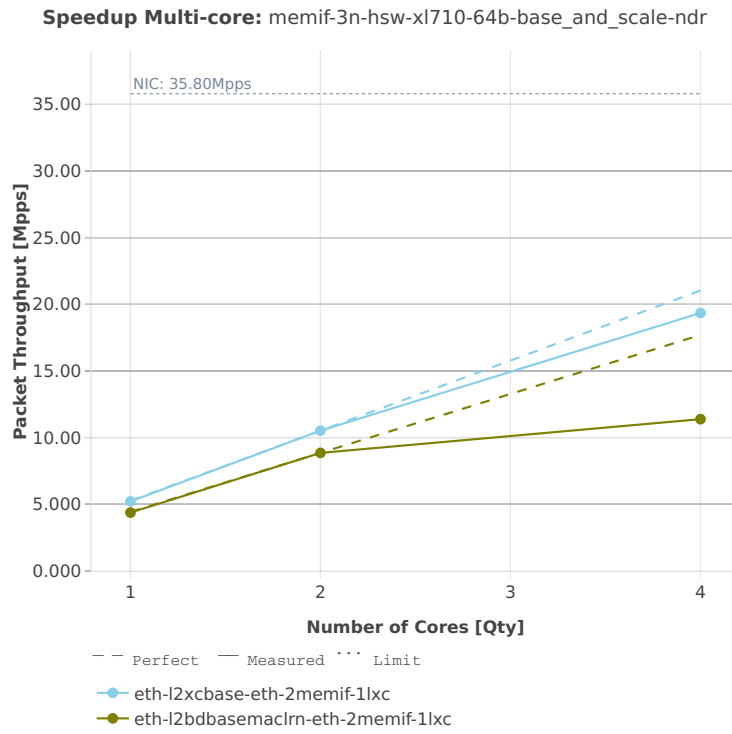

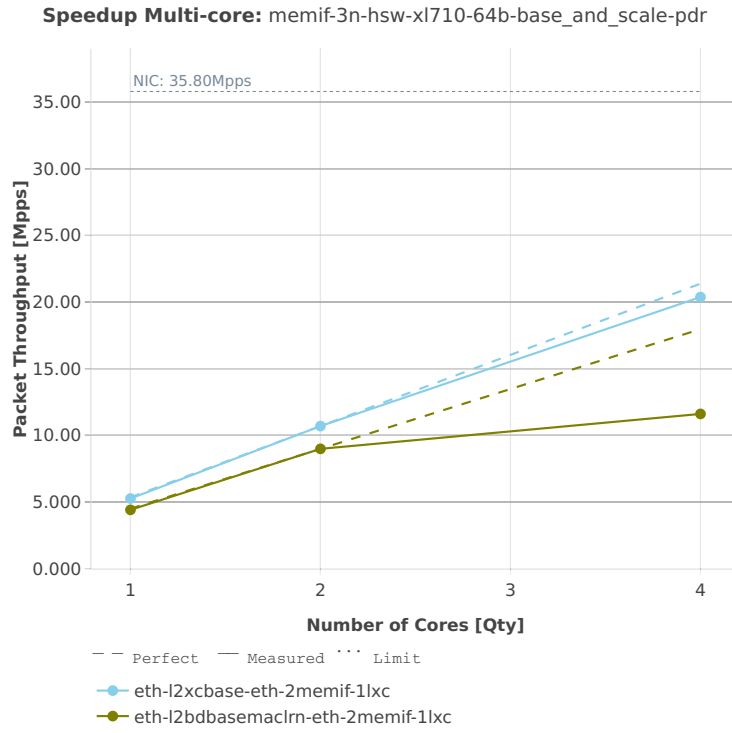

3n-skx-x710

64b-base\_and\_scale

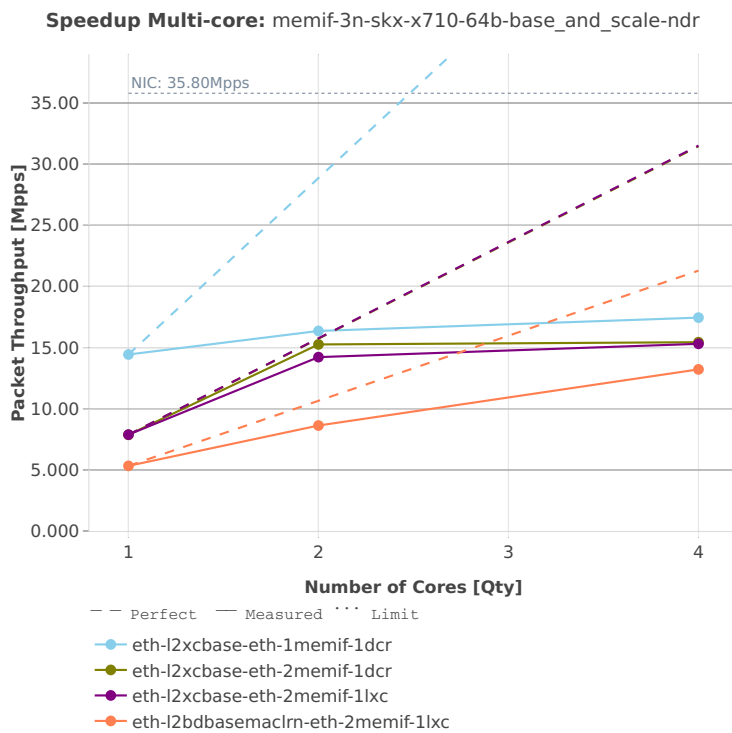

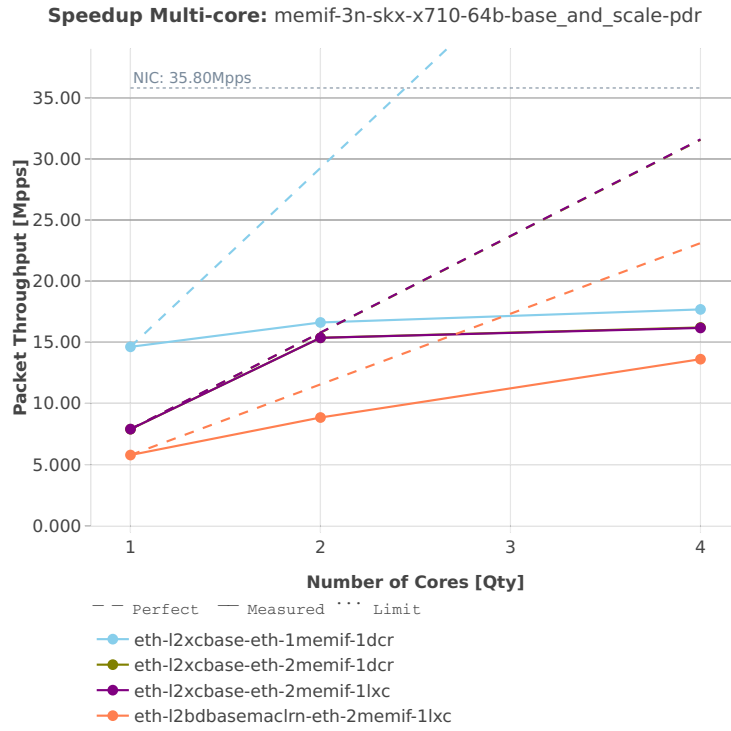

2n-skx-x710

64b-base\_and\_scale

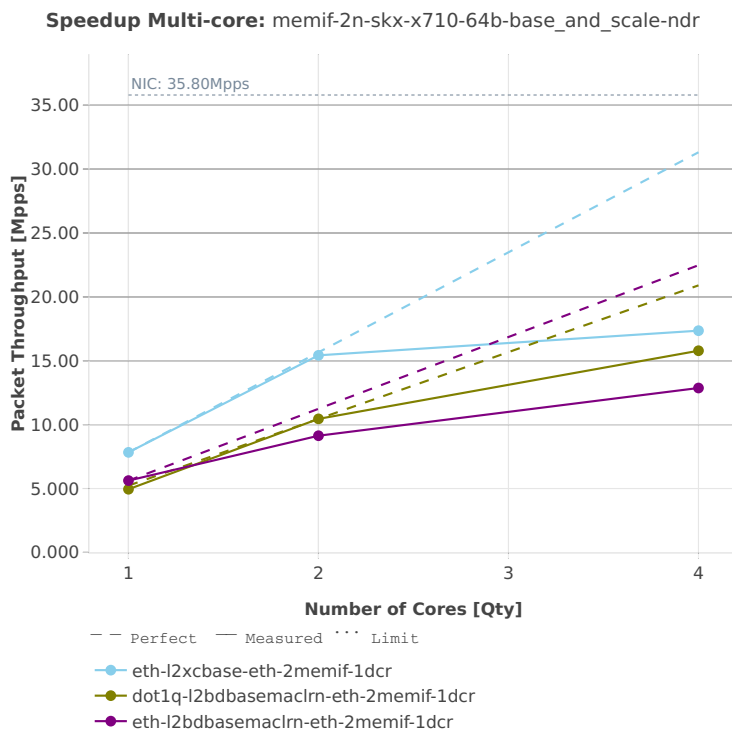

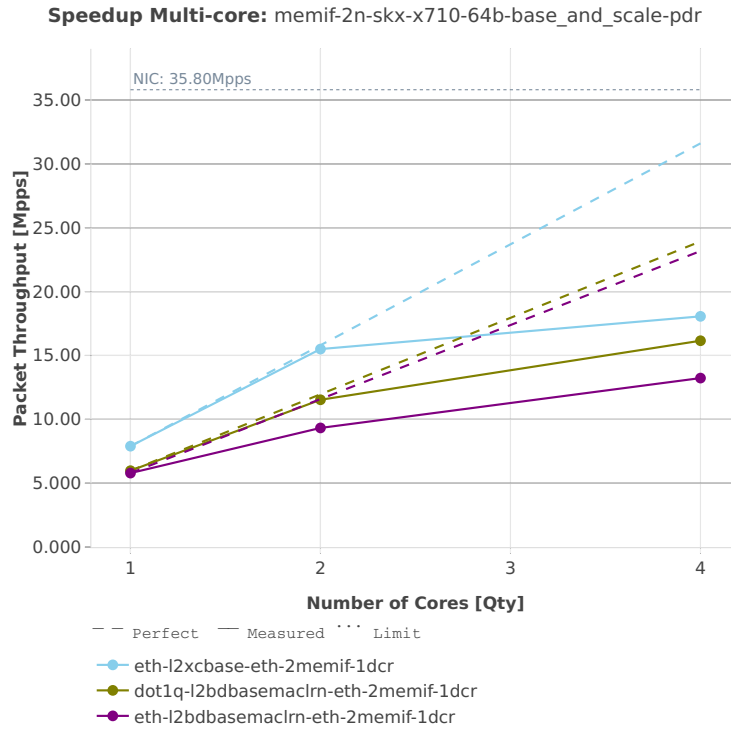

2n-skx-xxv710

64b-base\_and\_scale

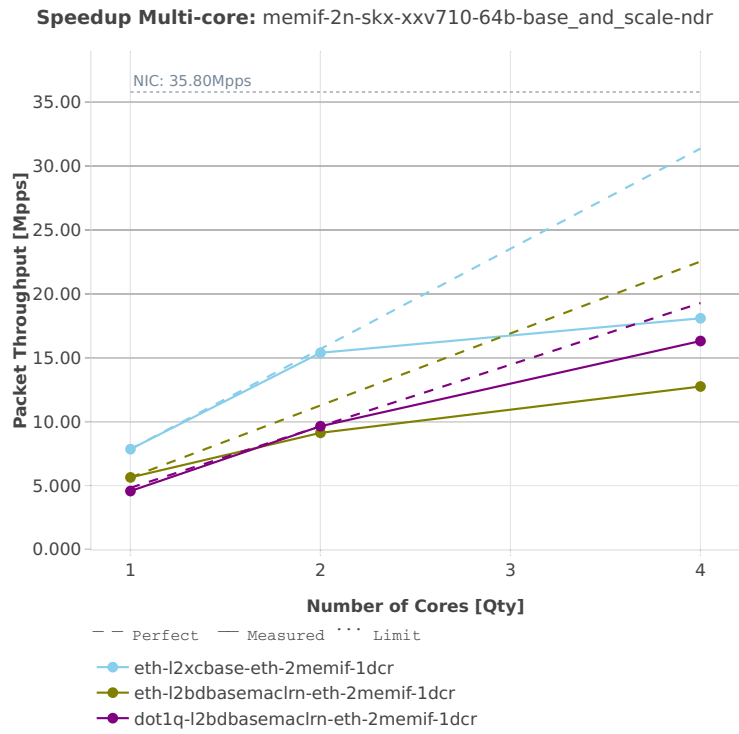

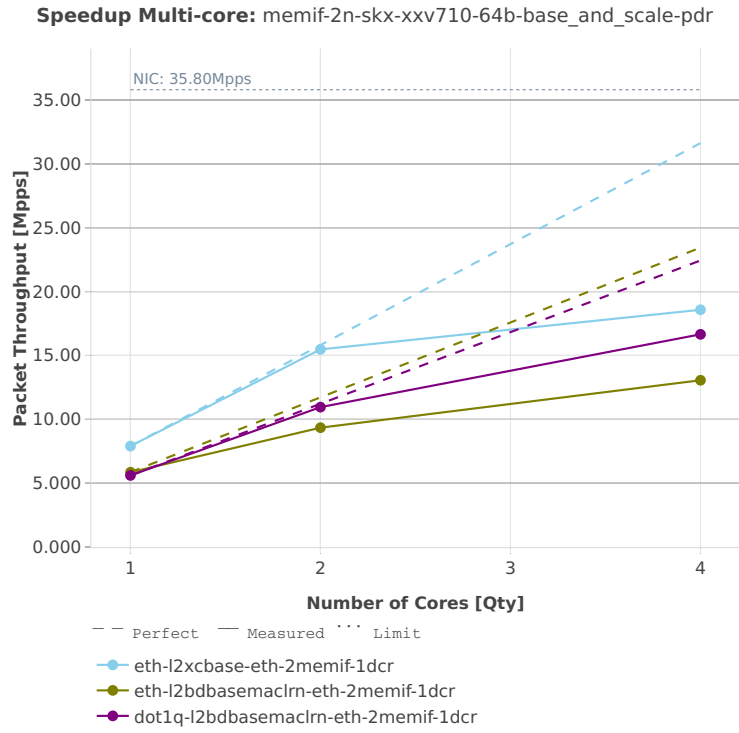



### 2.4.9 IPsec IPv4 Routing

Following sections include Throughput Speedup Analysis for VPP multi-core multi-thread configurations with no Hyper-Threading, specifically for tested 2t2c (2threads, 2cores) and 4t4c scenarios. 1t1c throughput results are used as a reference for reported speedup ratio. VPP IPsec encryption is accelerated using DPDK cryptodev library driving Intel Quick Assist (QAT) crypto PCIe hardware cards. Performance is reported for VPP running in multiple configurations of VPP worker thread(s), a.k.a. VPP data plane thread(s), and their physical CPU core(s) placement.

CSIT source code for the test cases used for plots can be found in [CSIT git repository](#)<sup>63</sup>.

---

<sup>63</sup> <https://git.fd.io/csit/tree/tests/vpp/perf/crypto?h=rls1901>

3n-hsw-xl710

64b-hw-base

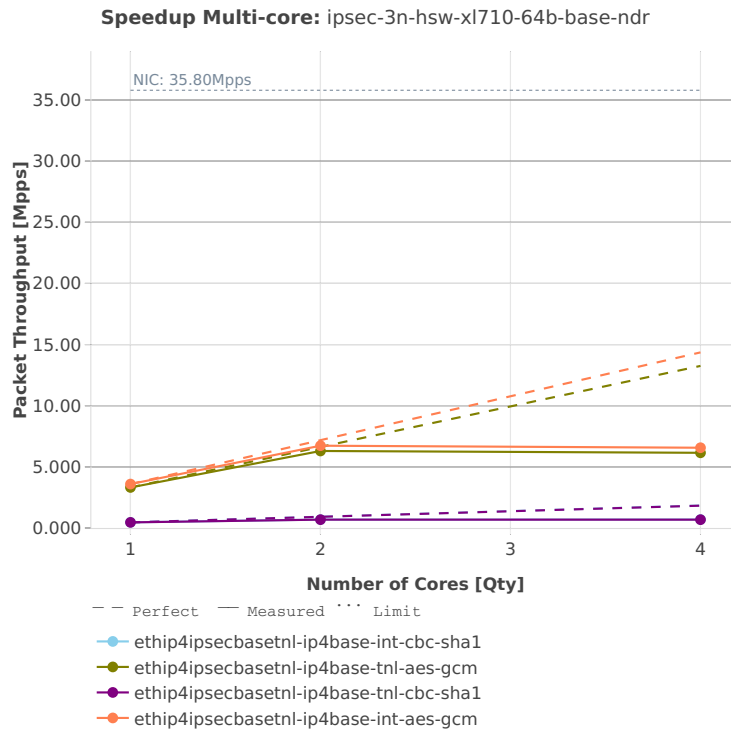

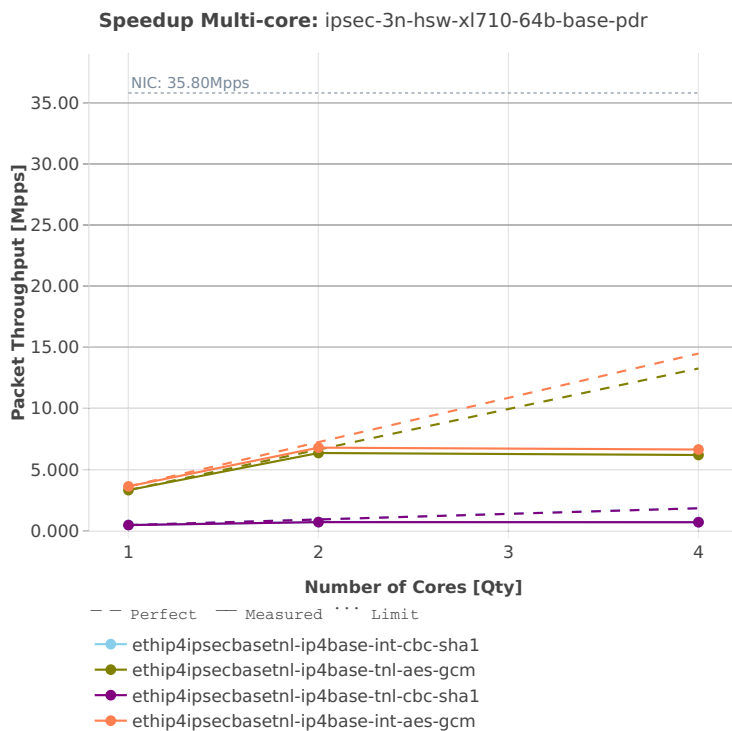

64b-hw-scale

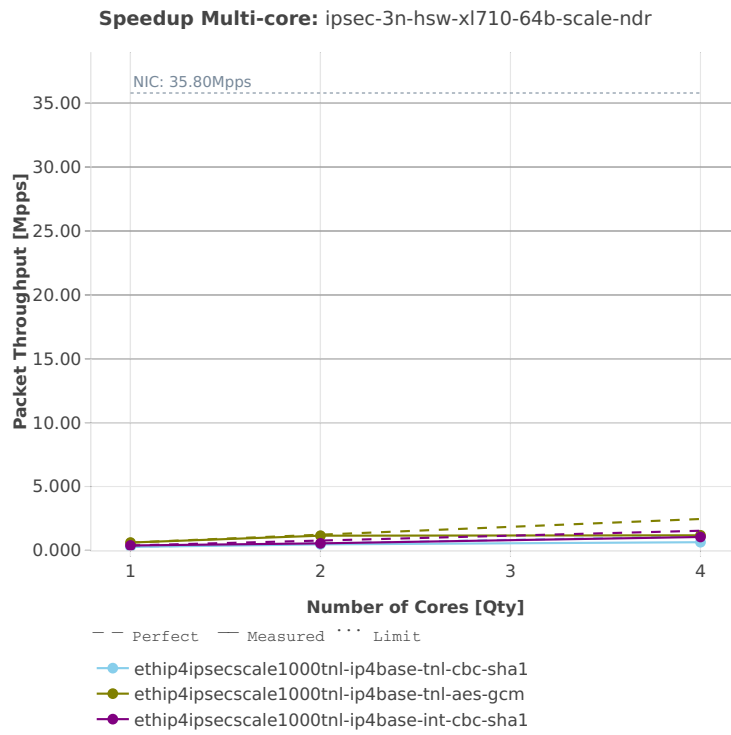

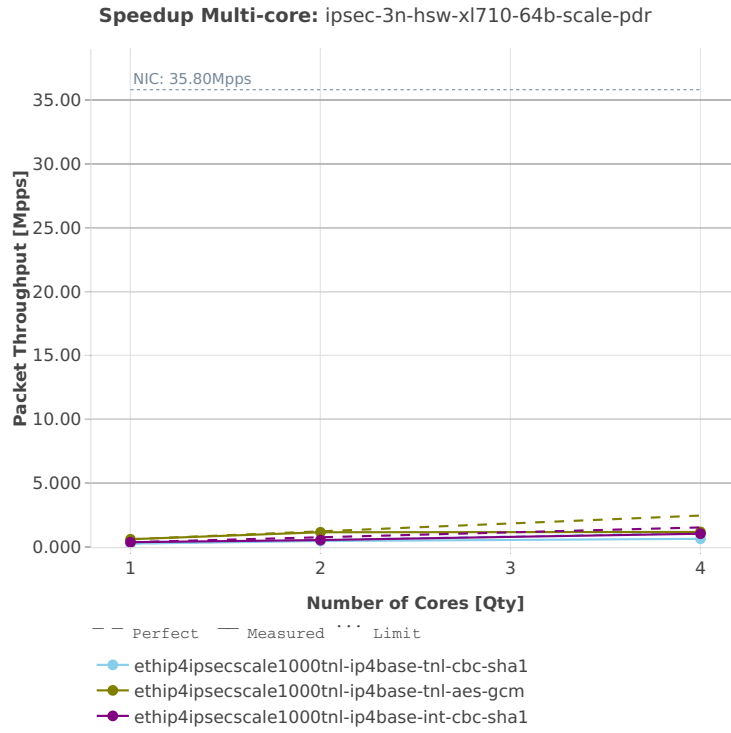

64b-sw-base

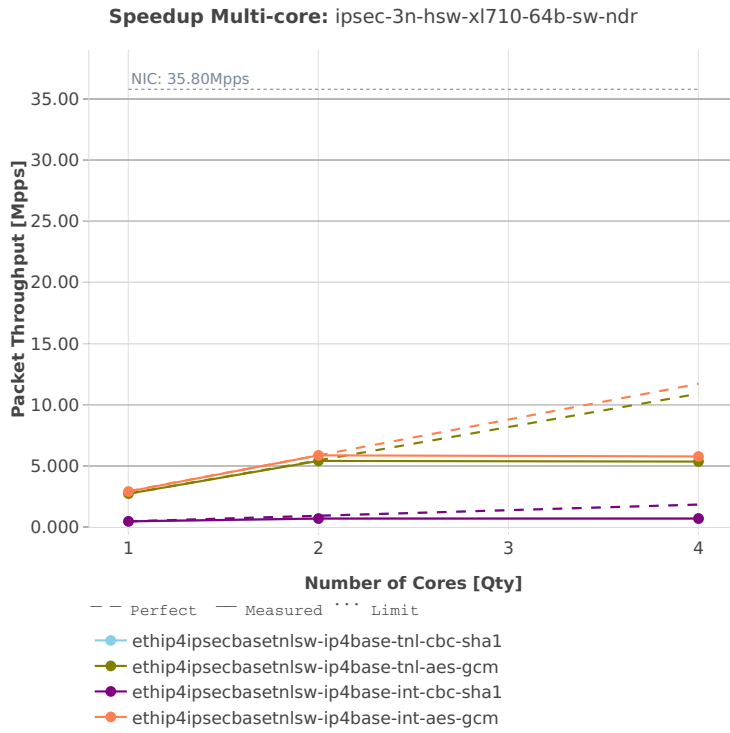

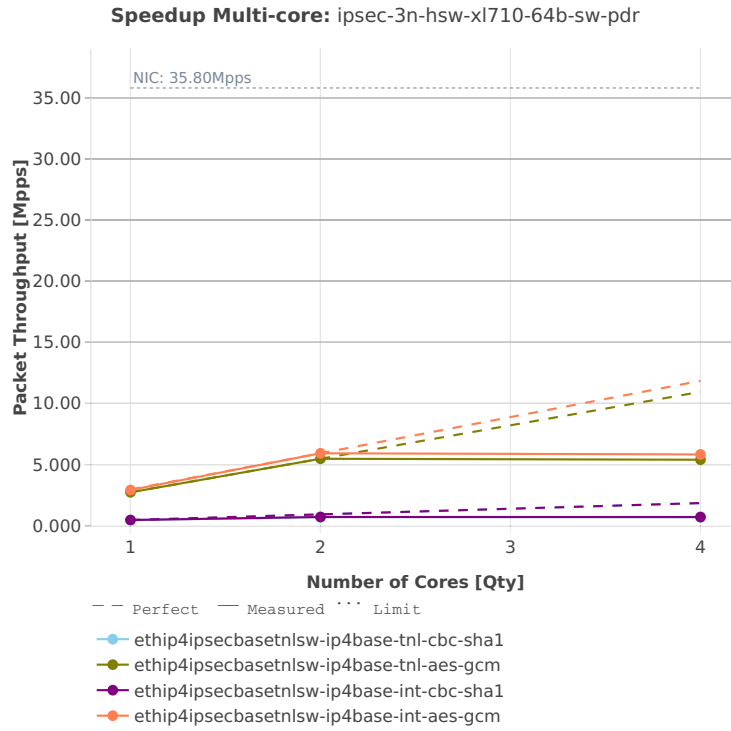

### 2.4.10 VTS

Following sections include Throughput Speedup Analysis for VPP multi-core multi-thread configurations with no Hyper-Threading, specifically for tested 2t2c (2threads, 2cores) and 4t4c scenarios. 1t1c throughput results are used as a reference for reported speedup ratio. Input data used for the graphs comes from Phy-to-Phy 64B performance tests with VM vhost-user, including NDR throughput (zero packet loss) and PDR throughput (<0.5% packet loss).

CSIT source code for the test cases used for plots can be found in [CSIT git repository](#)<sup>64</sup>.

---

<sup>64</sup> <https://git.fd.io/csit/tree/tests/vpp/perf/vts?h=rls1901>



3n-hsw-x520

114b-base\_and\_scale

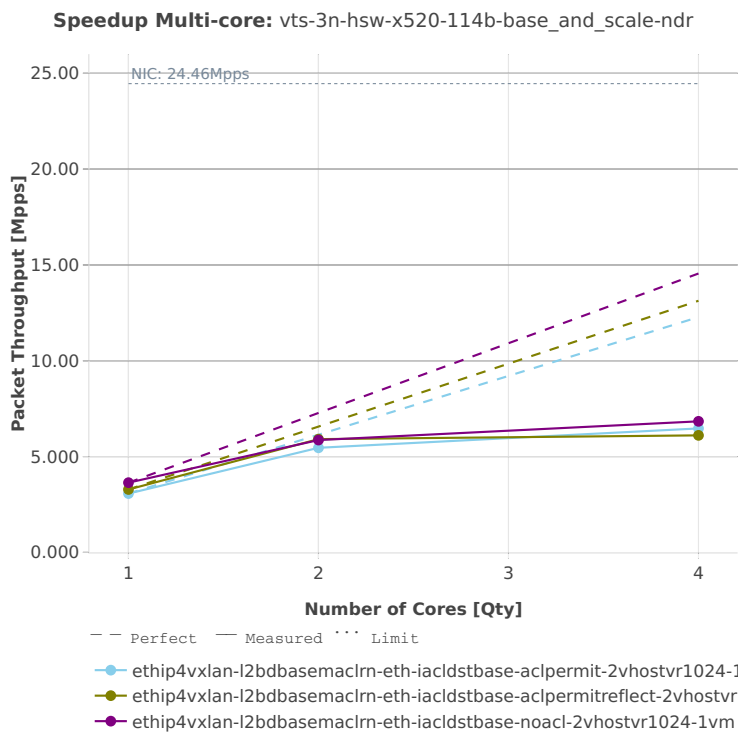

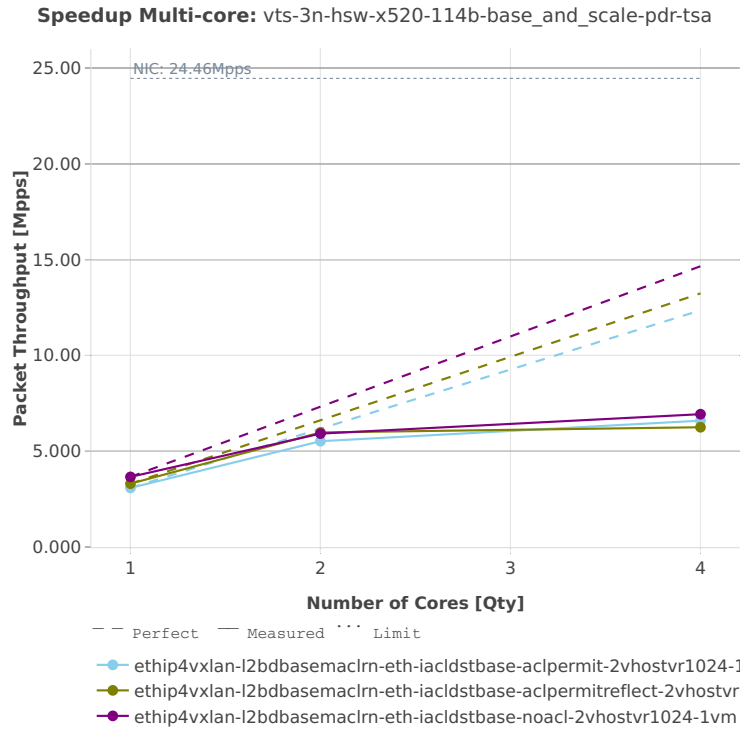

## 2.5 Packet Latency

Latency results are generated from a single execution of NDR discovery test across physical testbeds hosted LF FD.io labs: 3n-hsw, 2n-skx, 2n- skx. Box plots are used to show the Minimum, Median and Maximum packet latency per test.

Additional information about graph data:

1. **Graph Title:** describes tested packet path, testbed topology, processor model, NIC model, packet size, number of cores and threads used by data plane workers and indication of DUT configuration.
2. **X-axis Labels:** indices of individual test suites as listed in Graph Legend and direction of latency flow:
  - West-to-East: TGint1-to-SUT1-to-SUT2-to-TGint2.
  - East-to-West: TGint2-to-SUT2-to-SUT1-to-TGint1.
3. **Y-axis Labels:** measured packet latency values in [uSec].
4. **Graph Legend:** lists X-axis indices with associated CSIT test suites executed to generate graphed test results.
5. **Hover Information:** lists number of runs executed, specific test substring, packet flow direction, maximal, mean and minimal values of measured latencies.

---

**Note:** Test results have been generated by [FD.io test executor vpp performance job 3n-hsw<sup>65</sup>](#), [FD.io test executor vpp performance job 3n-skx<sup>66</sup>](#) and [FD.io test executor vpp performance job 2n-skx<sup>67</sup>](#) with RF result files csit-vpp-perf-1901-\*.zip [archived here](#).

---

<sup>65</sup> <https://jenkins.fd.io/view/csit/job/csit-vpp-perf-verify-1901-3n-hsw>

<sup>66</sup> <https://jenkins.fd.io/view/csit/job/csit-vpp-perf-verify-1901-3n-skx>

<sup>67</sup> <https://jenkins.fd.io/view/csit/job/csit-vpp-perf-verify-1901-2n-skx>

### 2.5.1 L2 Ethernet Switching

This section includes summary graphs of VPP Phy-to-Phy packet latency with L2 Ethernet switching measured at 100% of discovered NDR throughput rate. Latency is reported for VPP running in multiple configurations of VPP worker thread(s), a.k.a. VPP data plane thread(s), and their physical CPU core(s) placement.

CSIT source code for the test cases used for plots can be found in [CSIT git repository](#)<sup>68</sup>.

---

<sup>68</sup> <https://git.fd.io/csit/tree/tests/vpp/perf/l2?h=rls1901>

3n-hsw-x520

64b-1t1c-base\_and\_scale

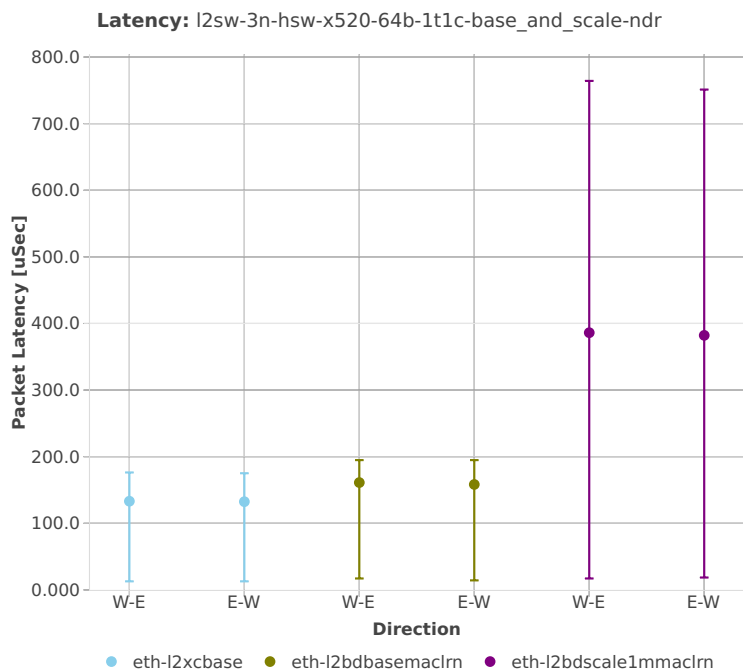

64b-2t2c-base\_and\_scale

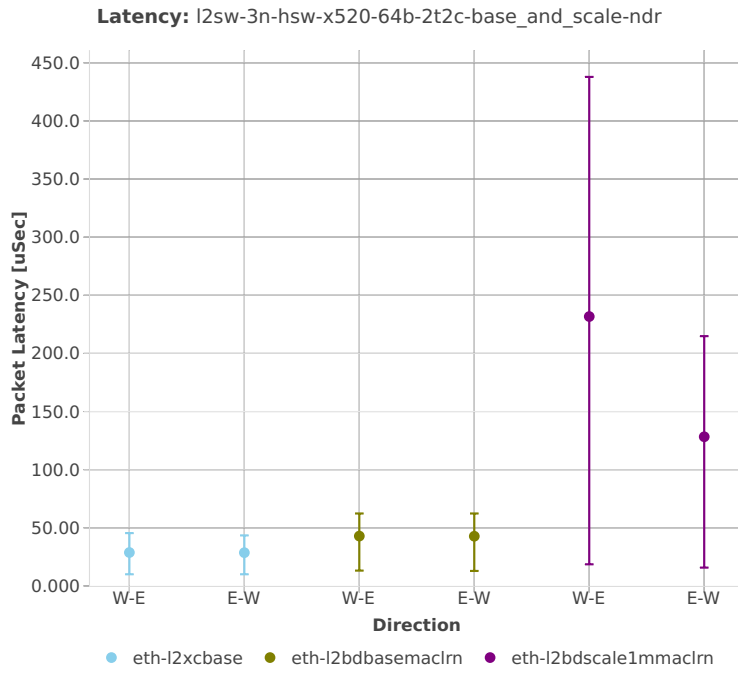

64b-1t1c-features

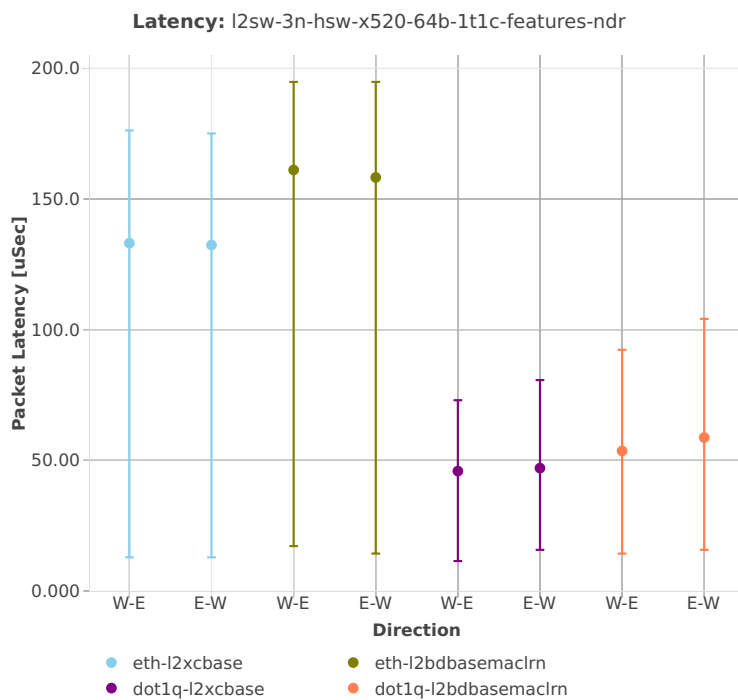

64b-2t2c-features

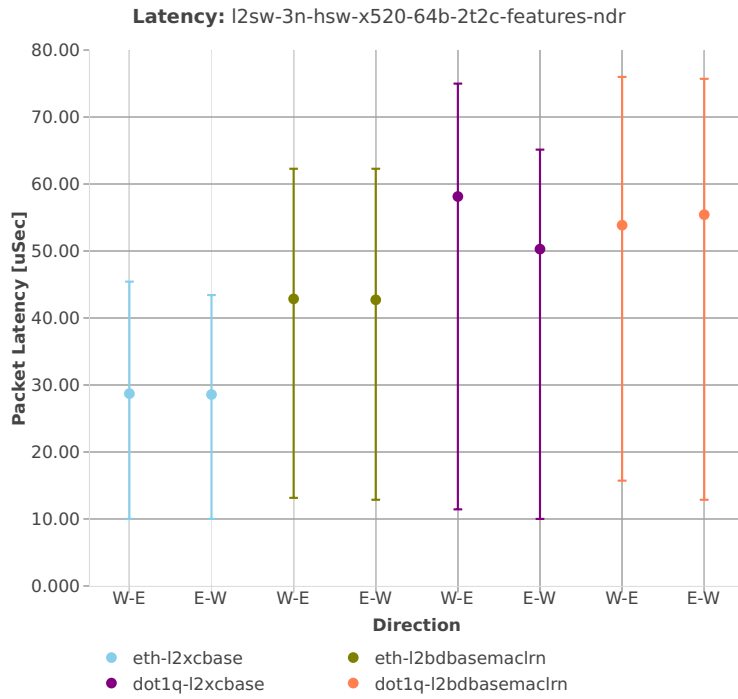



3n-hsw-x710

64b-1t1c-base\_and\_scale

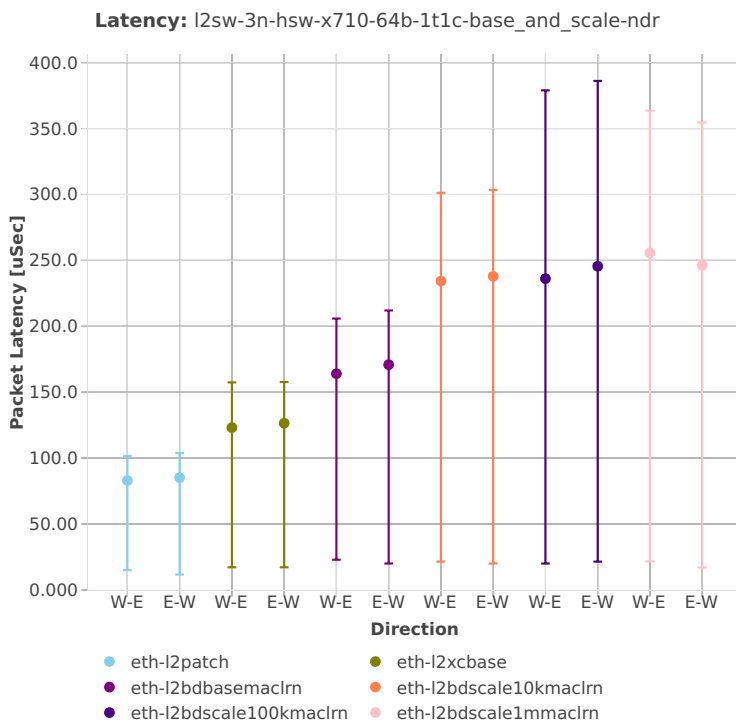

64b-2t2c-base\_and\_scale

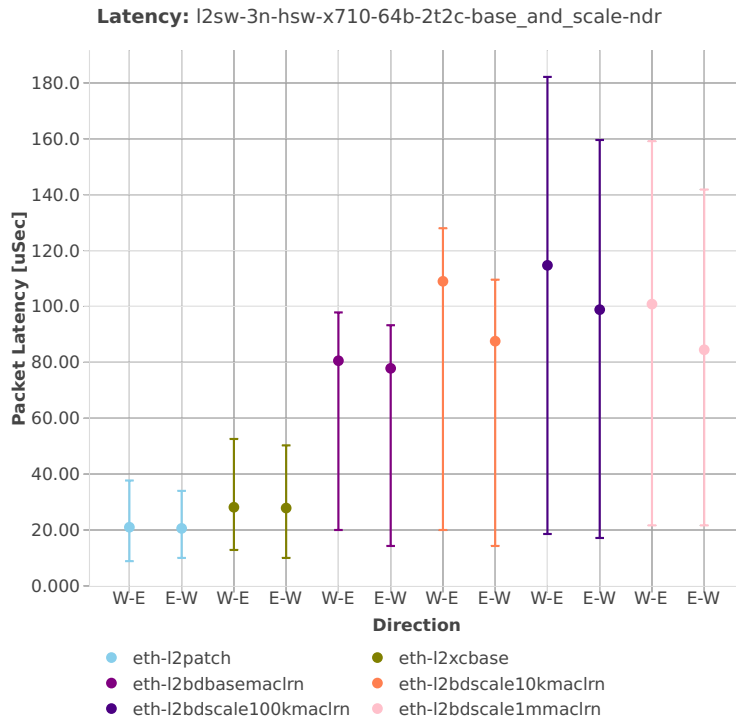

64b-1t1c-features

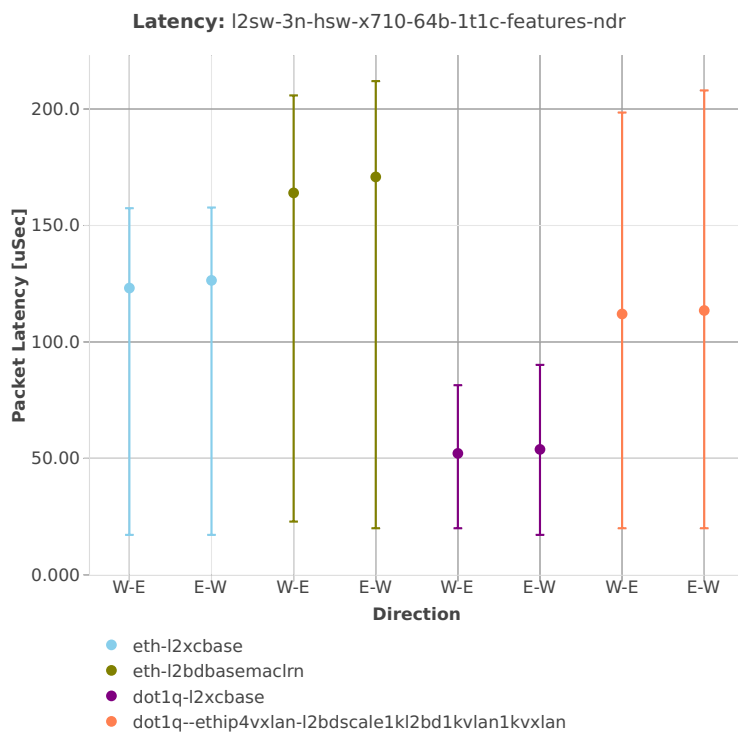

64b-2t2c-features

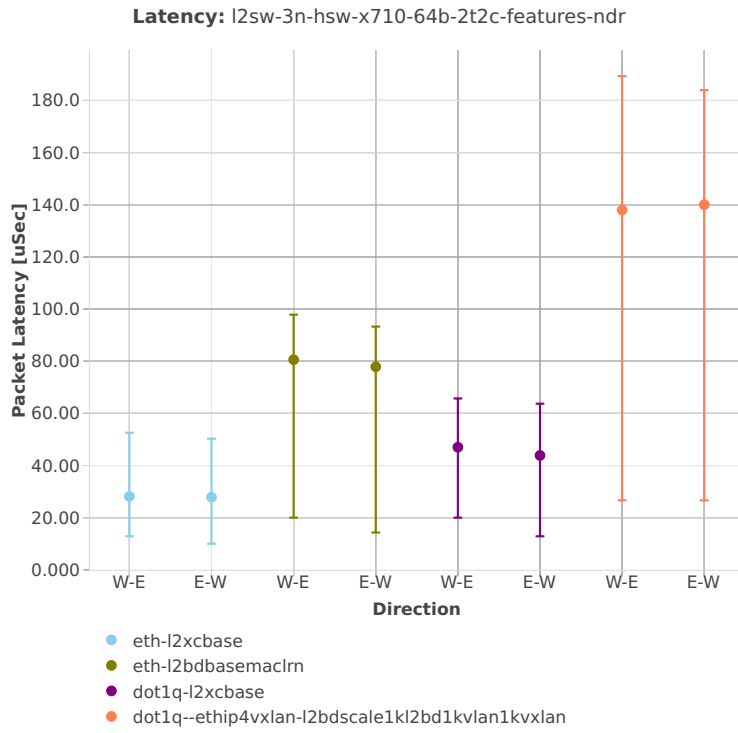

3n-hsw-xl710

64b-1t1c-base\_and\_scale

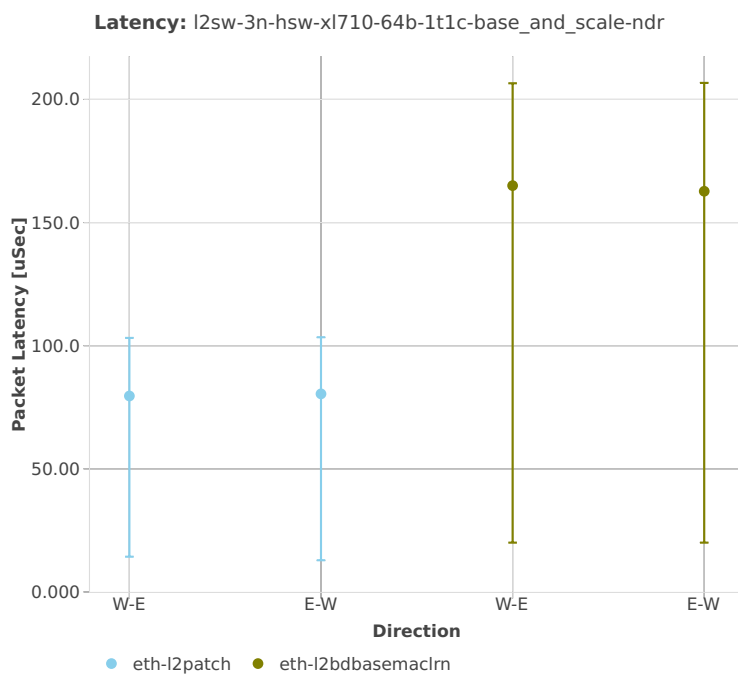

## 64b-2t2c-base\_and\_scale

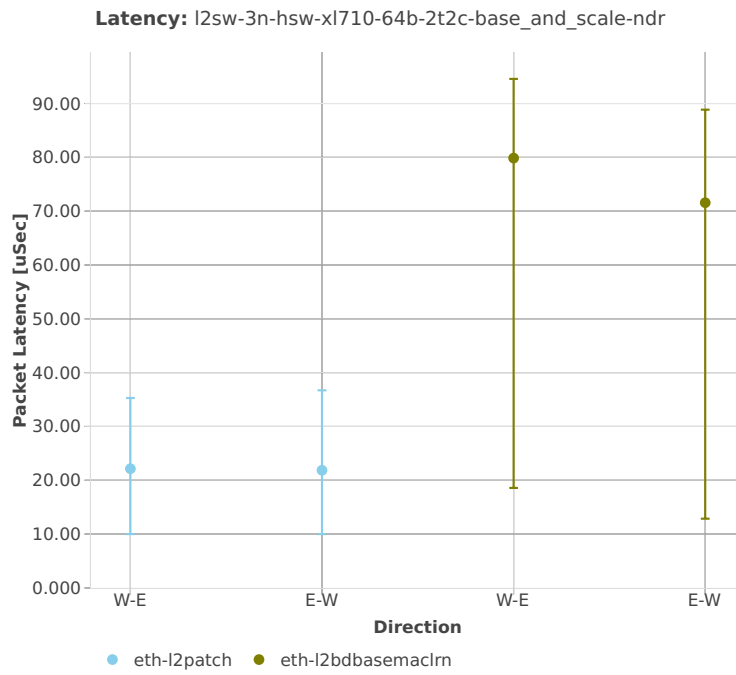

3n-skx-x710

64b-2t1c-base\_and\_scale

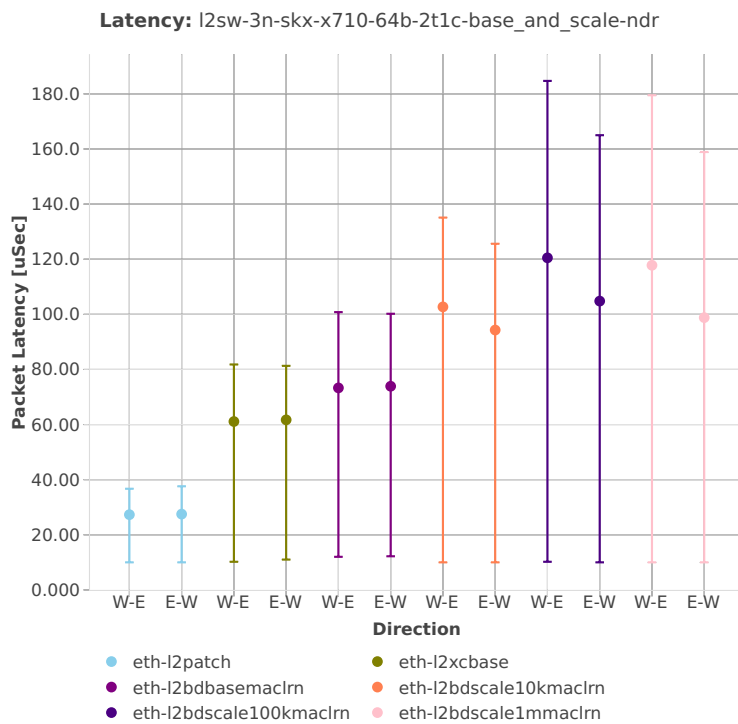

64b-4t2c-base\_and\_scale

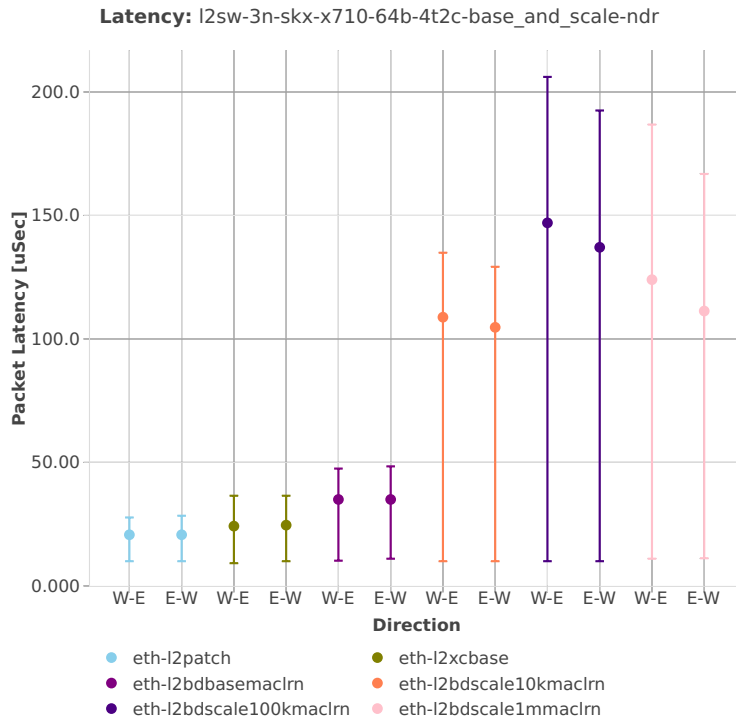



64b-2t1c-features

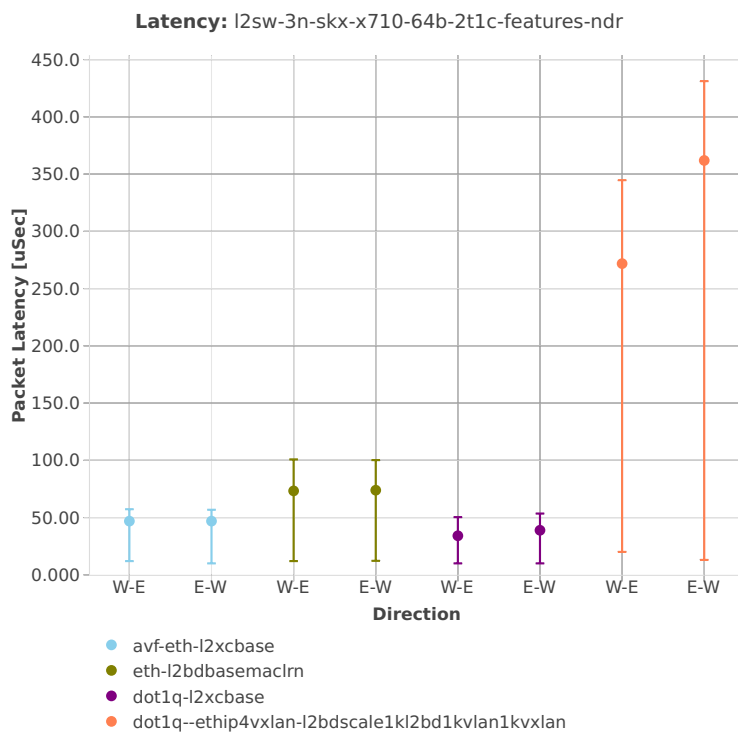

64b-4t2c-features

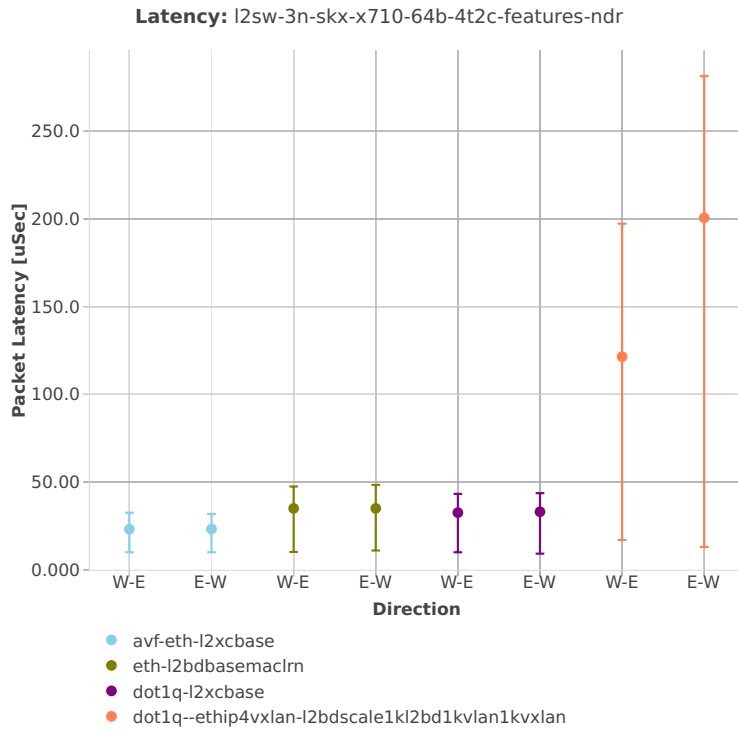

3n-skx-xxv710

64b-2t1c-base\_and\_scale

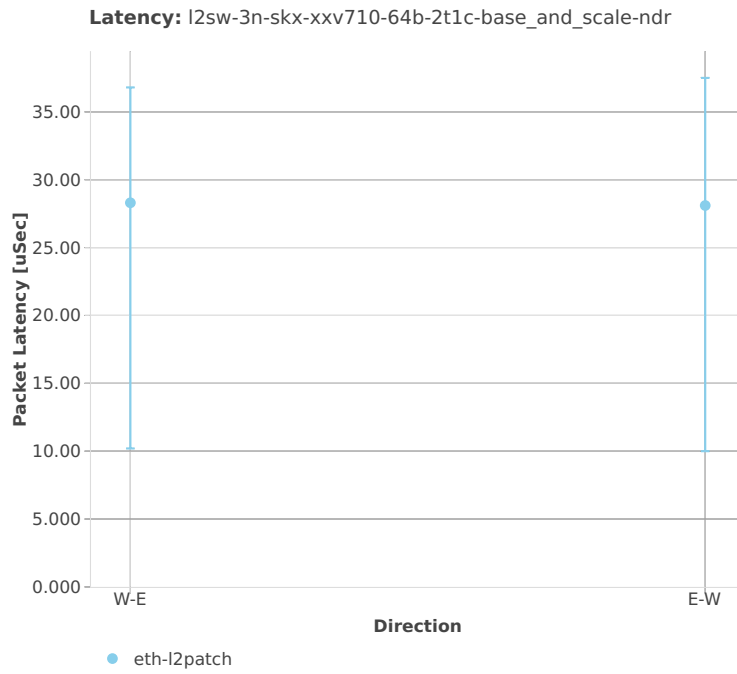

64b-4t2c-base\_and\_scale

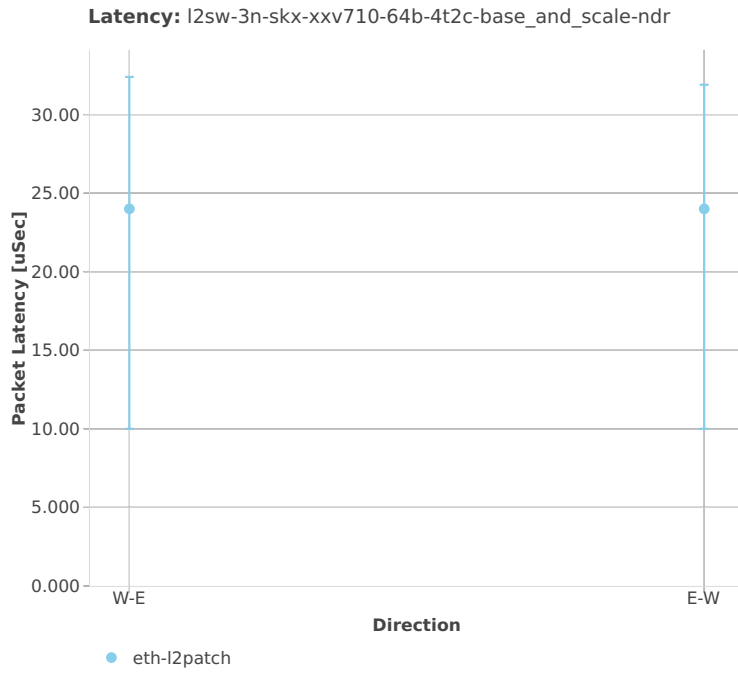

2n-skx-x710

64b-2t1c-base\_and\_scale

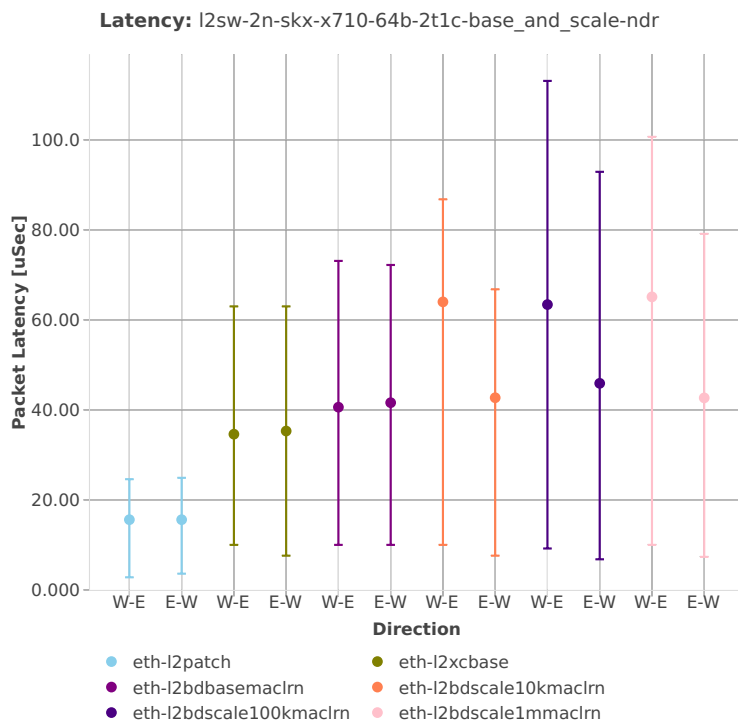

64b-4t2c-base\_and\_scale

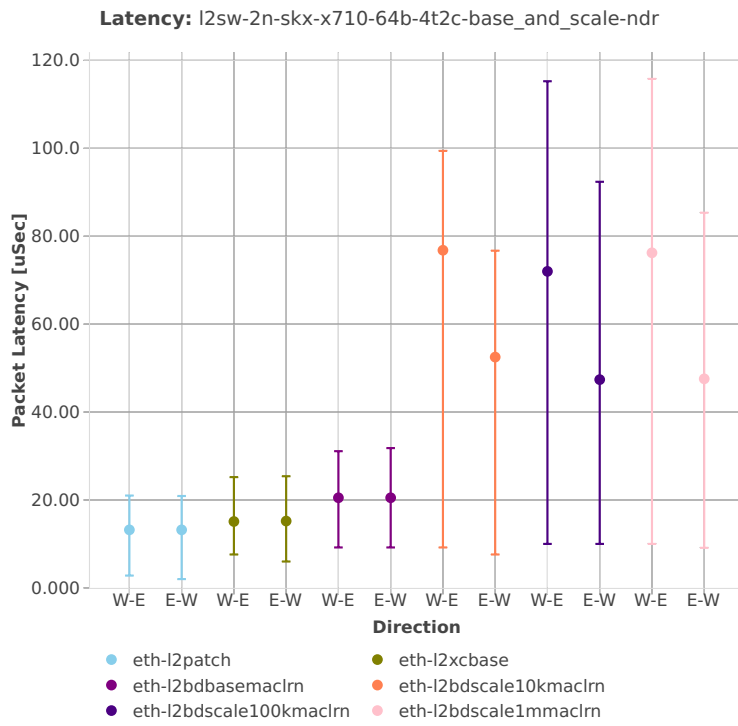

2n-skx-xxv710

64b-2t1c-base\_and\_scale

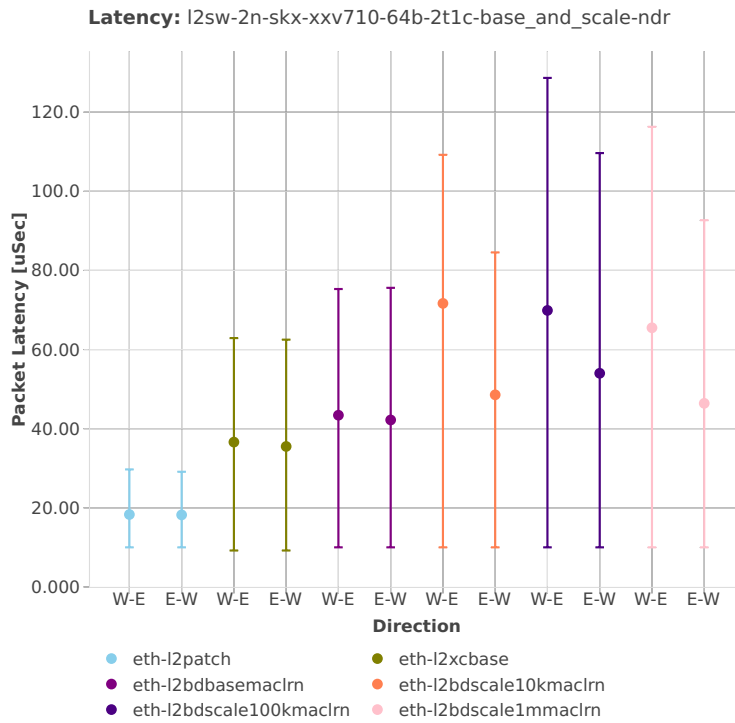

64b-4t2c-base\_and\_scale

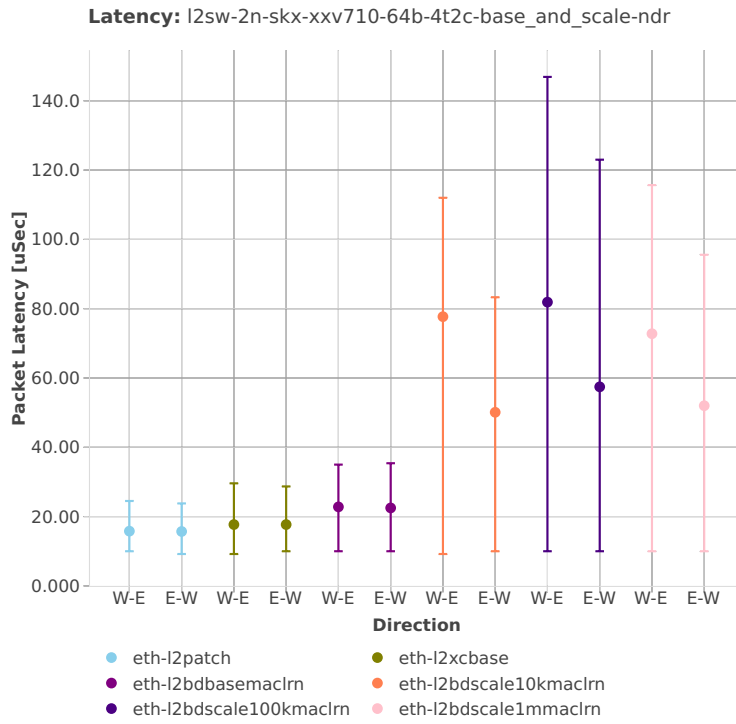



## 2.5.2 IPv4 Routing

This section includes summary graphs of VPP Phy-to-Phy packet latency with IPv4 Routed-Forwarding measured at 100% of discovered NDR throughput rate. Latency is reported for VPP running in multiple configurations of VPP worker thread(s), a.k.a. VPP data plane thread(s), and their physical CPU core(s) placement.

CSIT source code for the test cases used for plots can be found in [CSIT git repository](#)<sup>69</sup>.

---

<sup>69</sup> <https://git.fd.io/csit/tree/tests/vpp/perf/ip4?h=rls1901>

3n-hsw-x520

64b-1t1c-base\_and\_scale

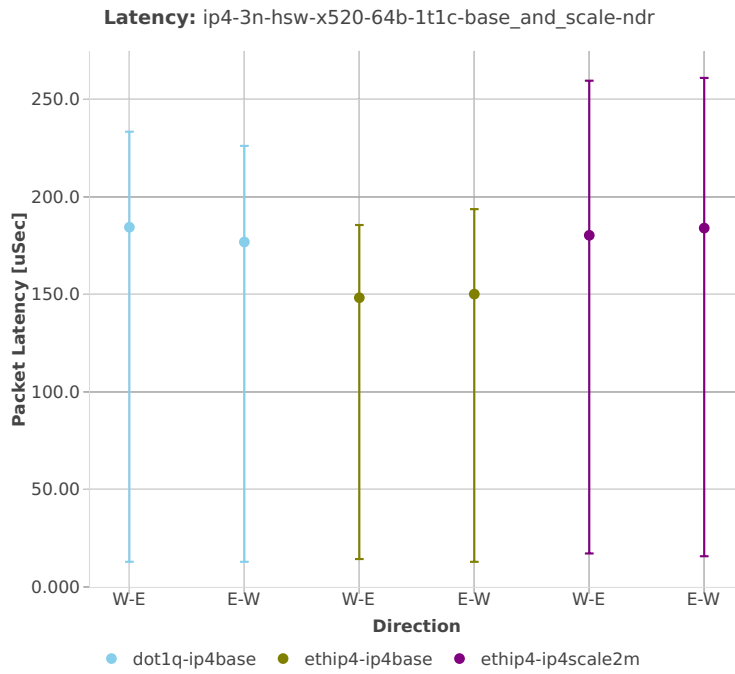

64b-2t2c-base\_and\_scale

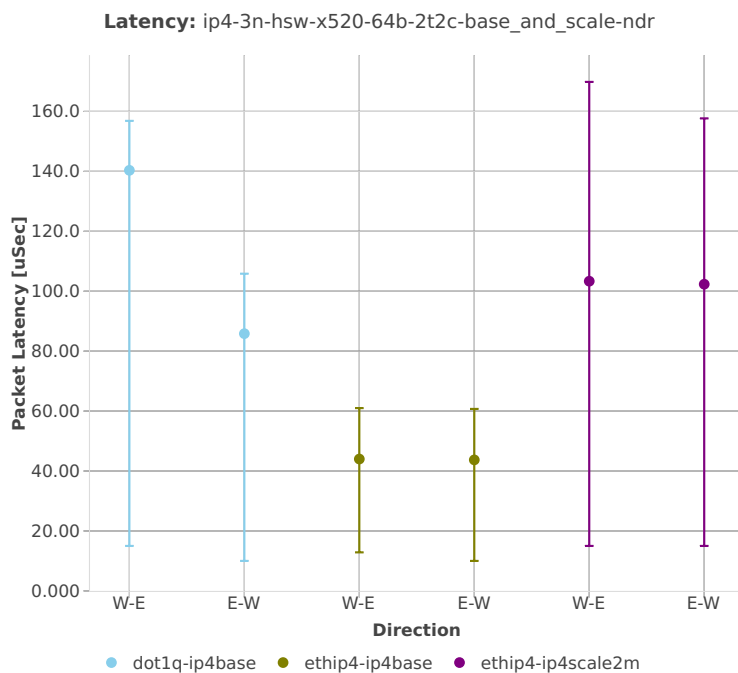

64b-1t1c-features

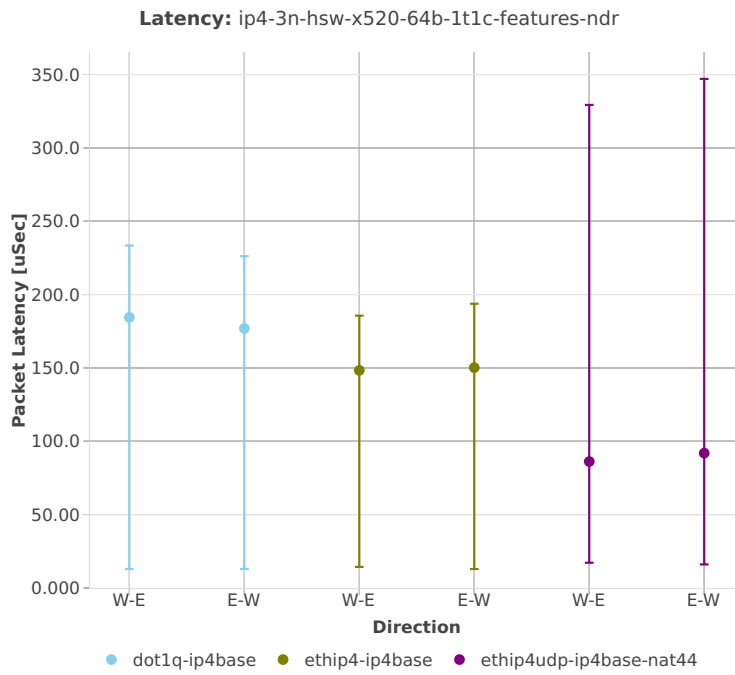

64b-2t2c-features

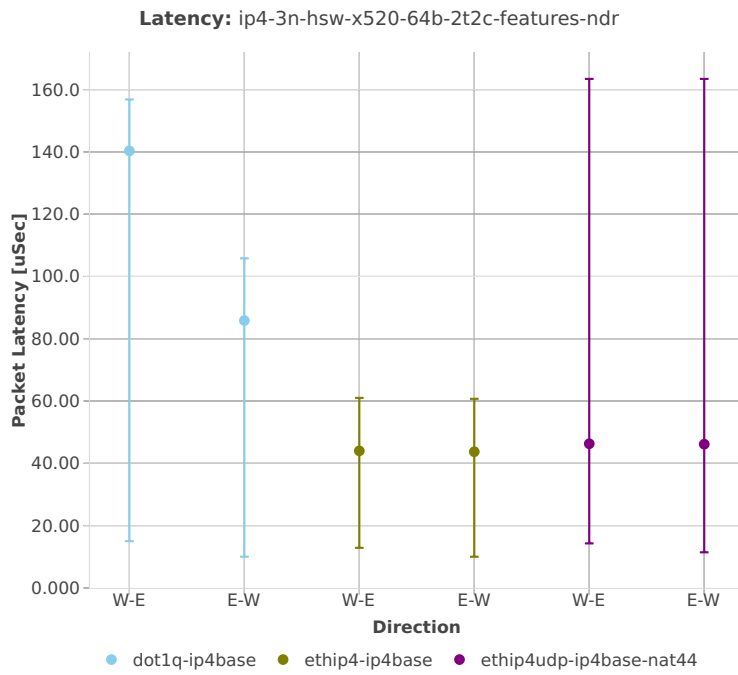

64b-1t1c-features-nat44

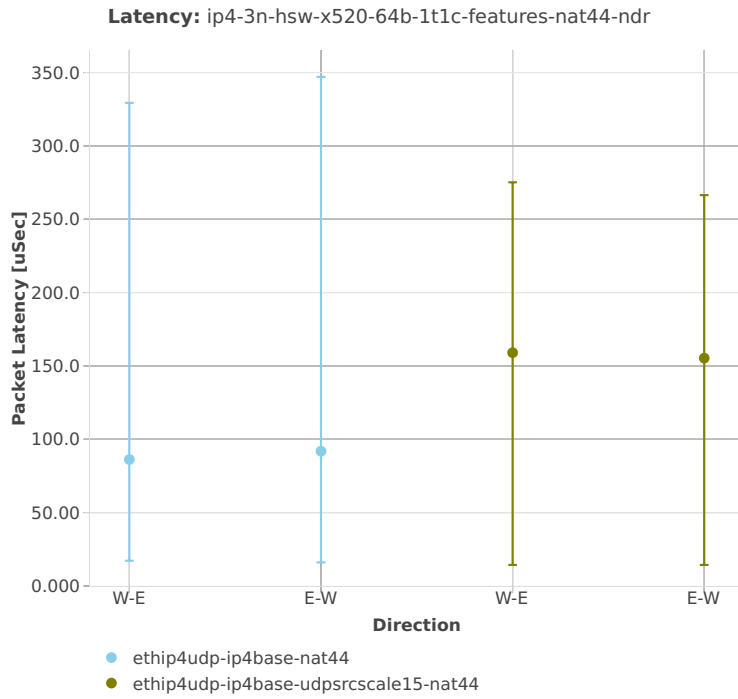

64b-2t2c-features-nat44

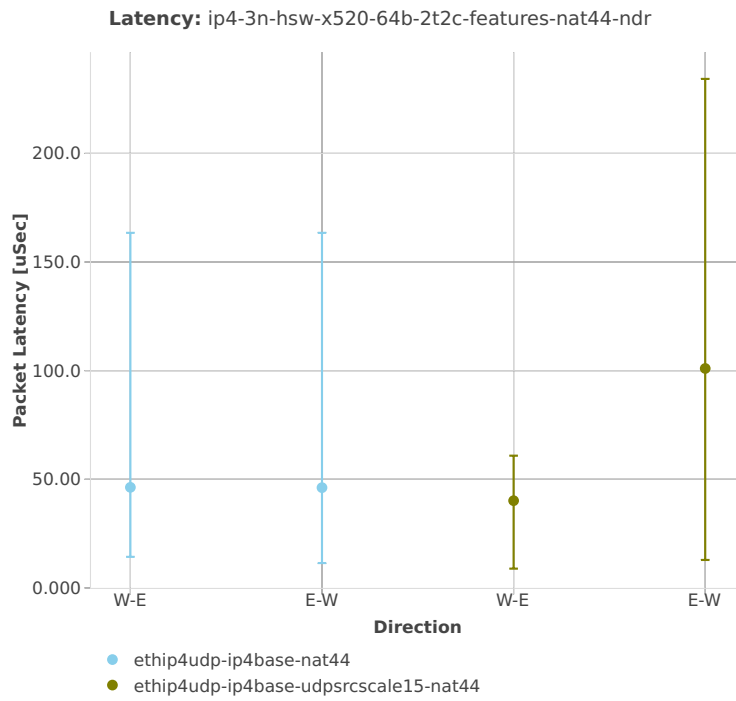

64b-1t1c-features-iacl

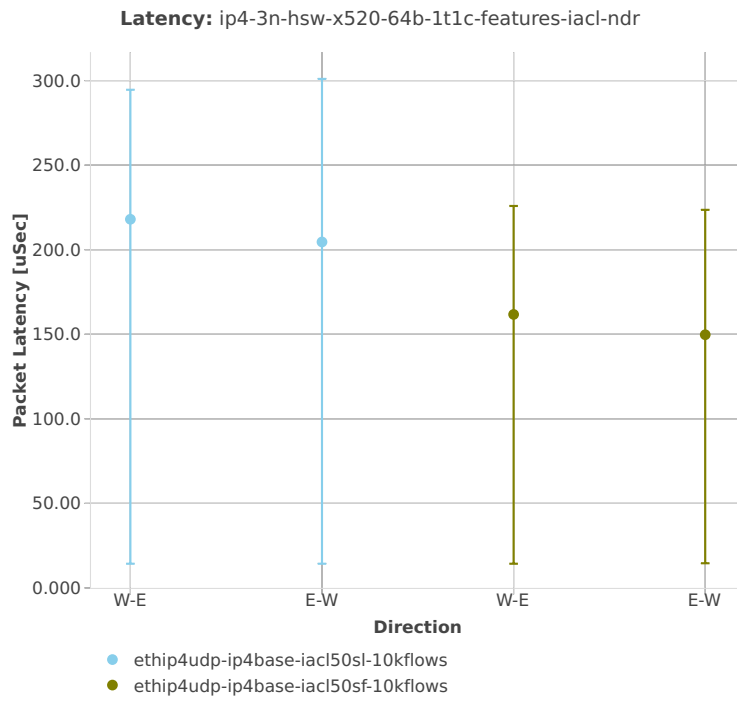



64b-2t2c-features-iacl

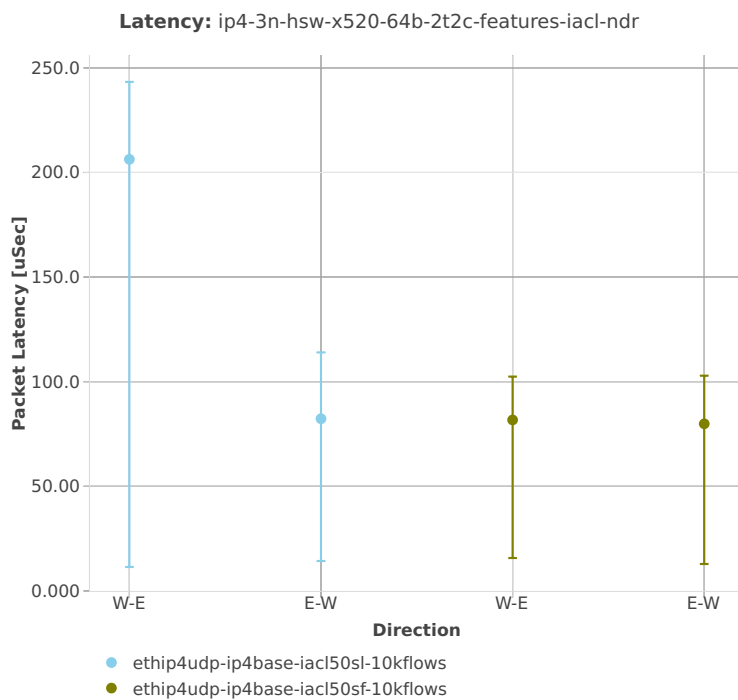

64b-1t1c-features-oacl

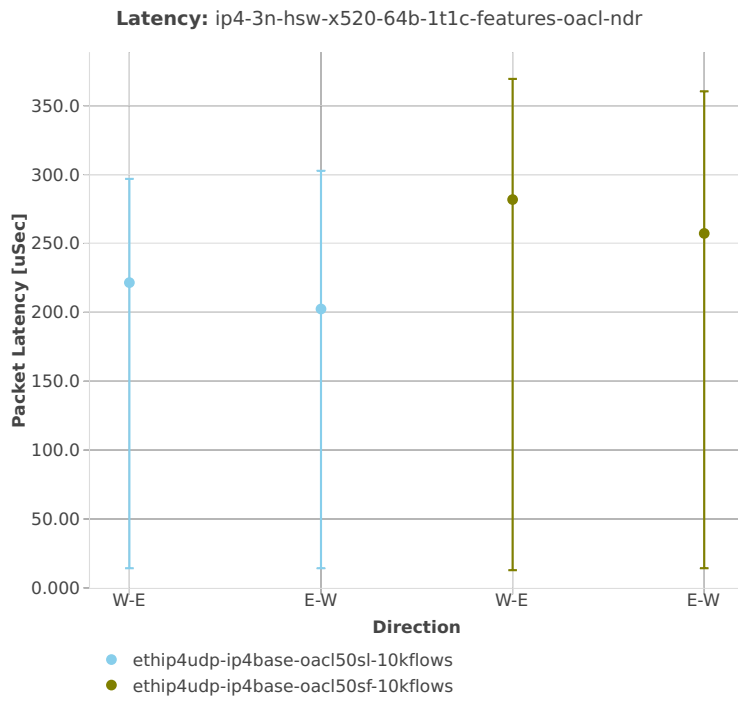

64b-2t2c-features-oacl

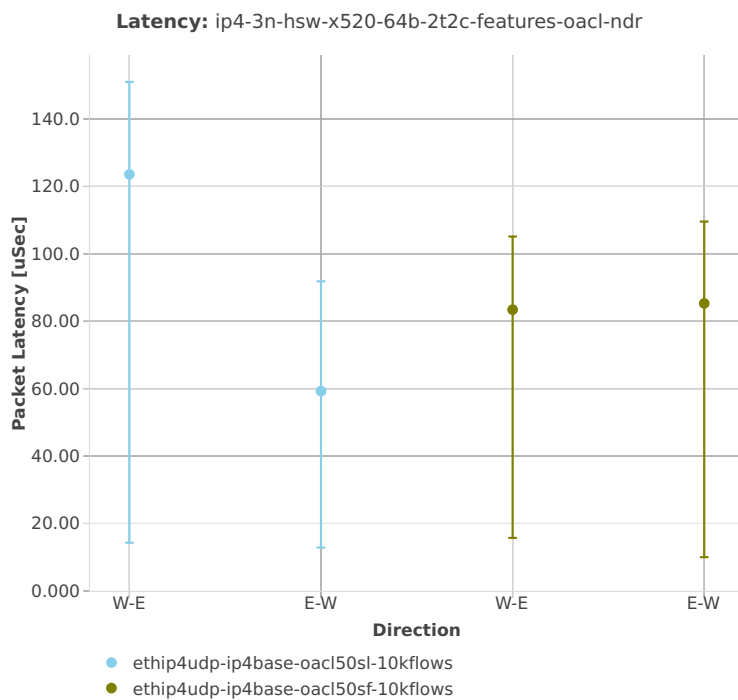

3n-hsw-x710

64b-1t1c-base\_and\_scale

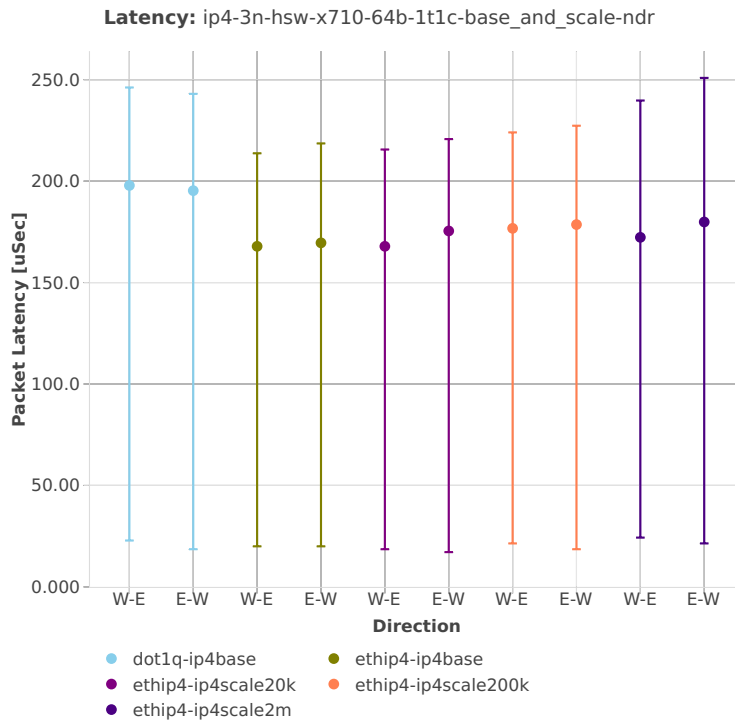

64b-2t2c-base\_and\_scale

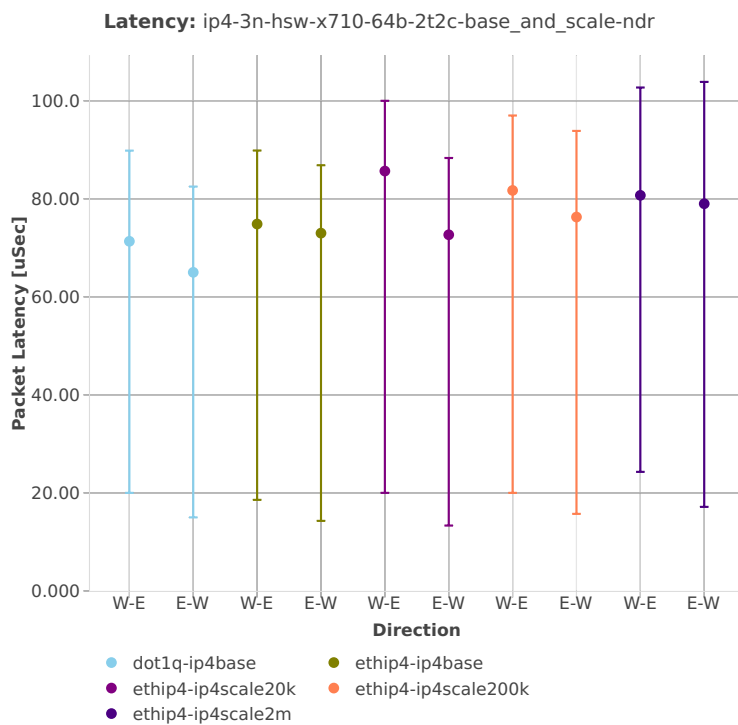

64b-1t1c-features

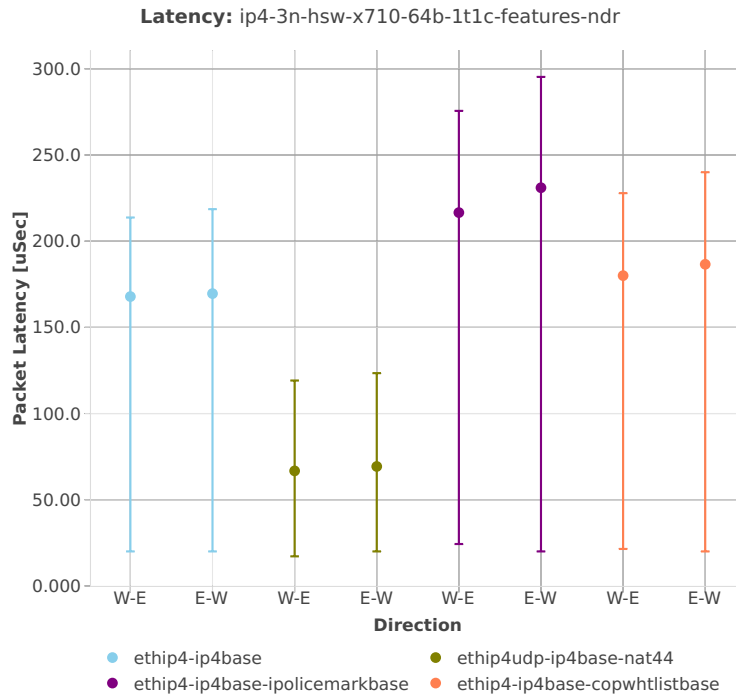

64b-2t2c-features

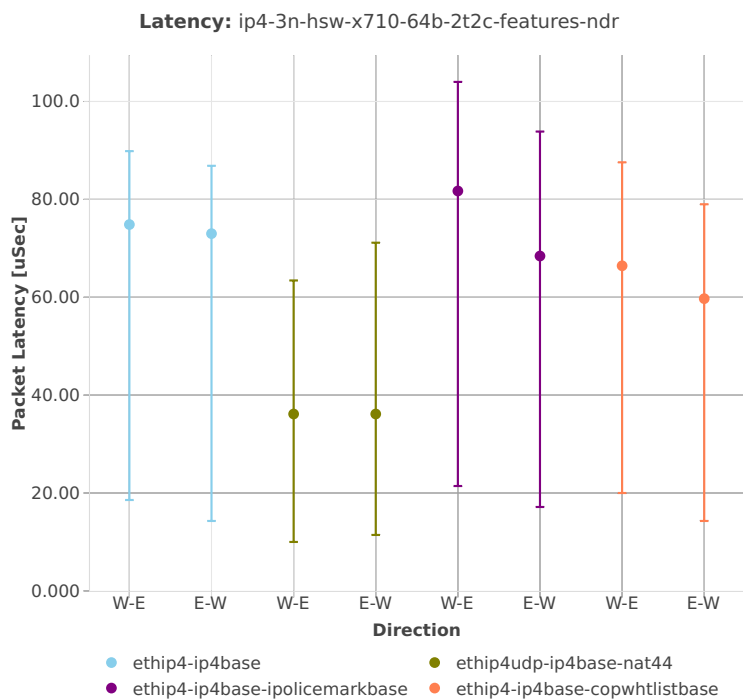

64b-1t1c-features-nat44

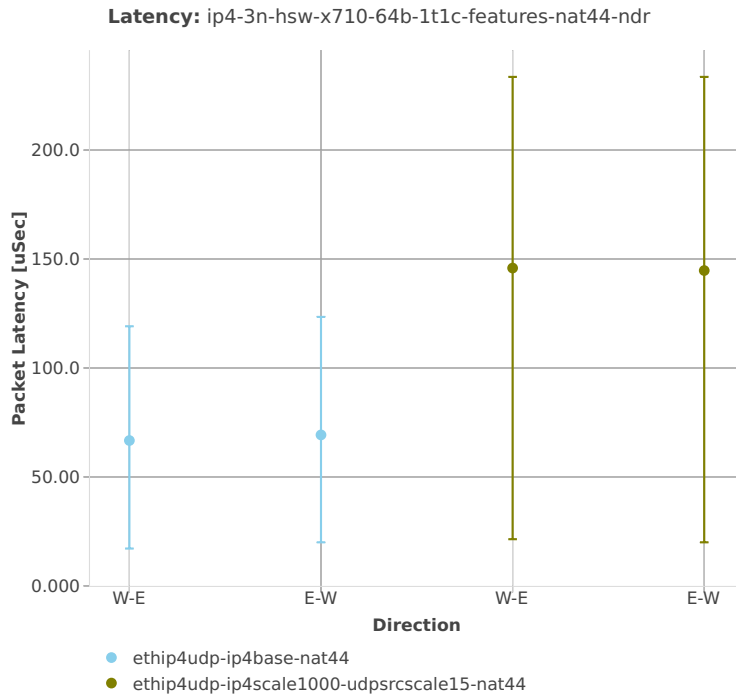



64b-2t2c-features-nat44

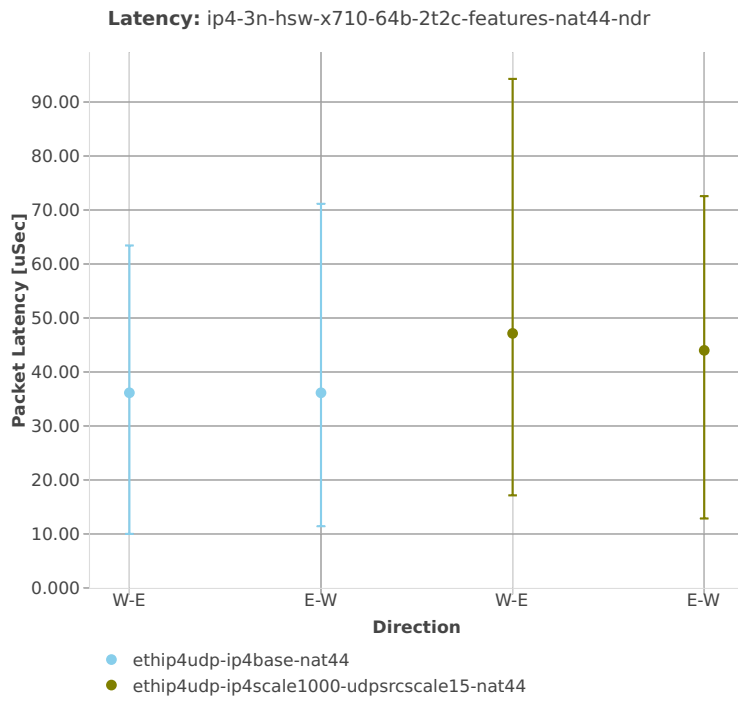

64b-1t1c-features-iacl

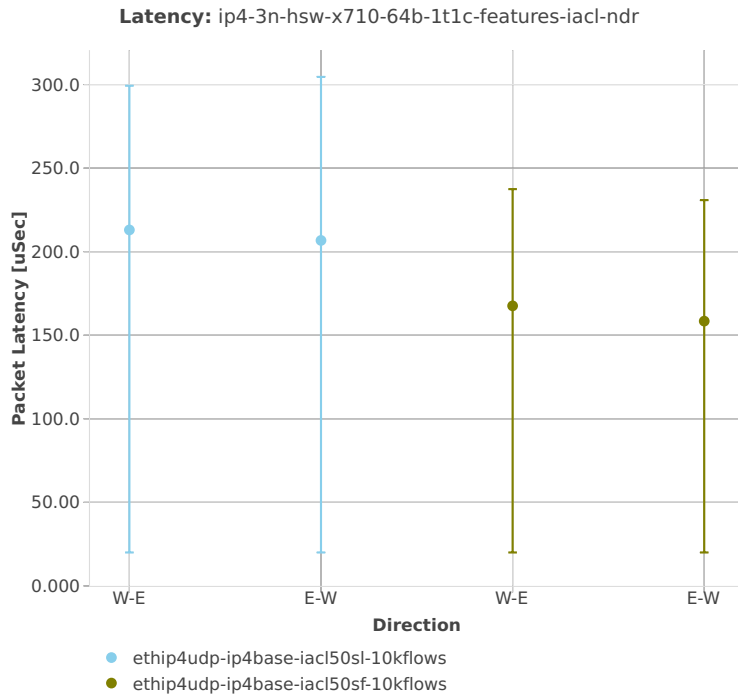

64b-2t2c-features-iacl

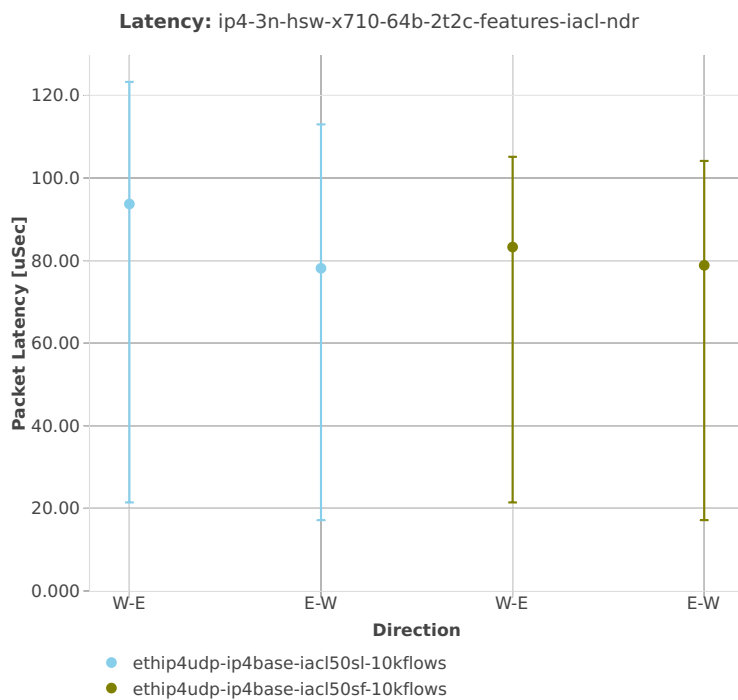

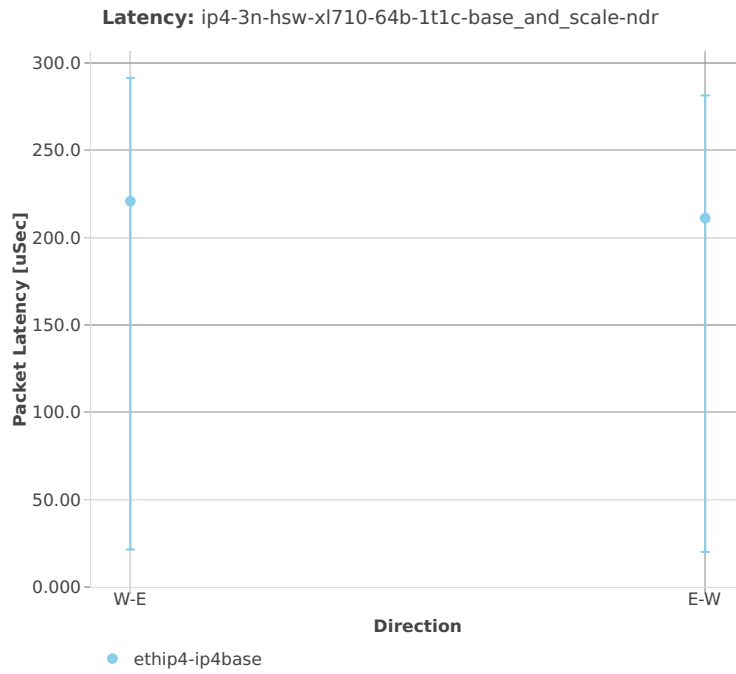
**3n-hsw-xl710****64b-1t1c-base\_and\_scale**

### 64b-2t2c-base\_and\_scale

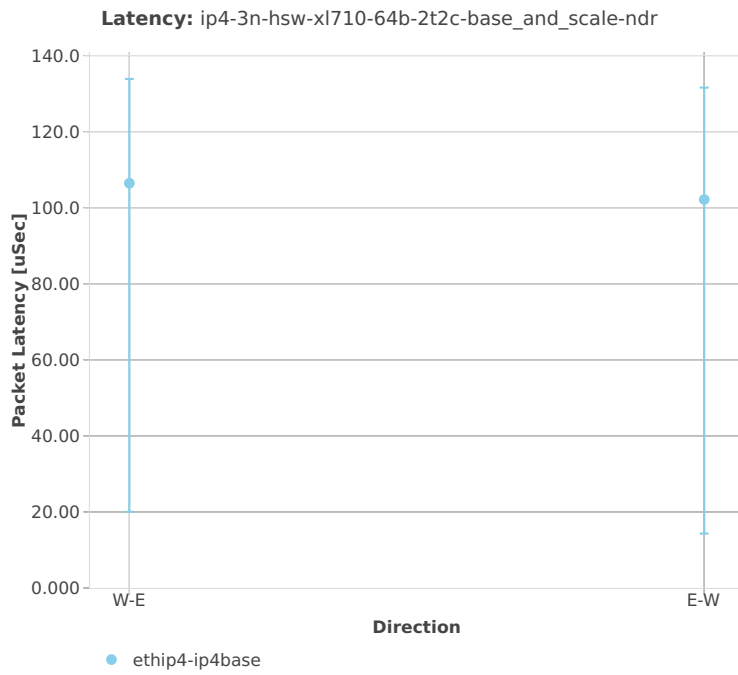

3n-skx-x710

64b-2t1c-base\_and\_scale

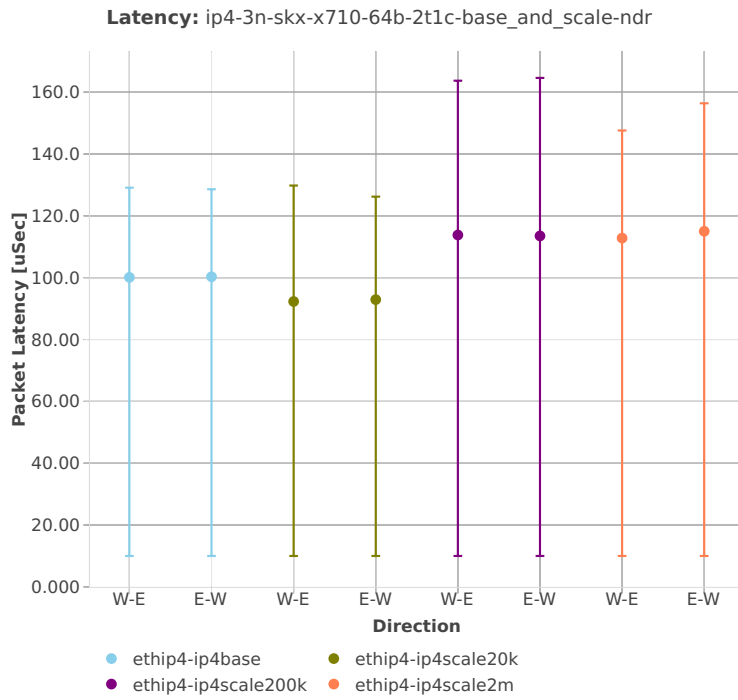

64b-4t2c-base\_and\_scale

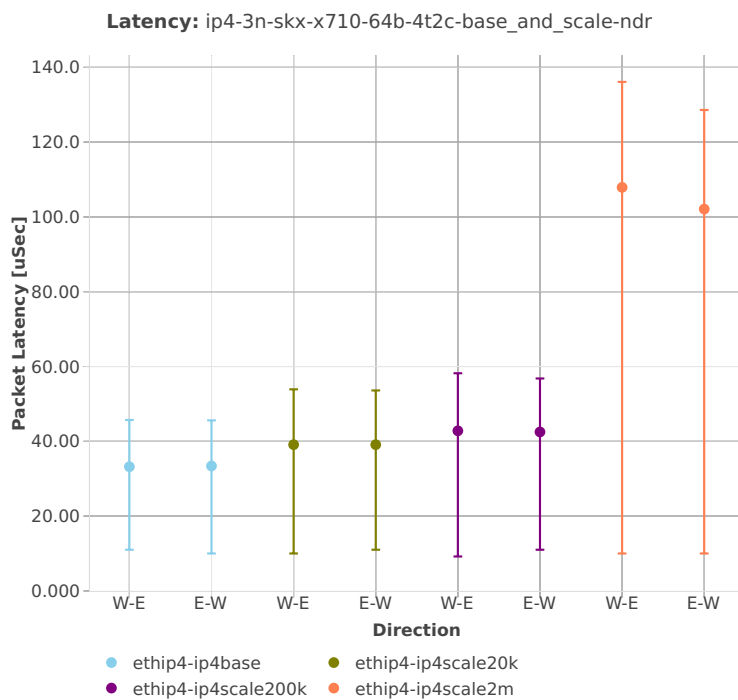

64b-2t1c-features

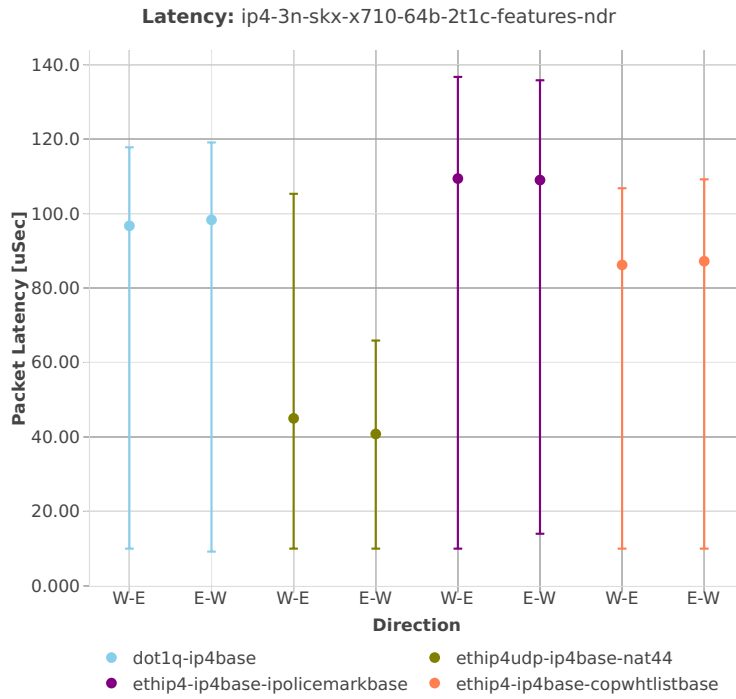



64b-4t2c-features

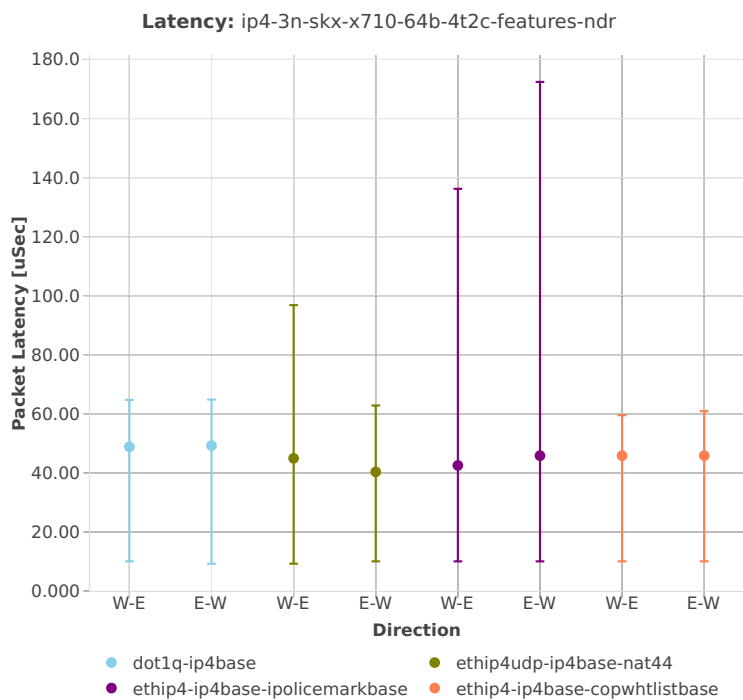

64b-2t1c-features-nat44

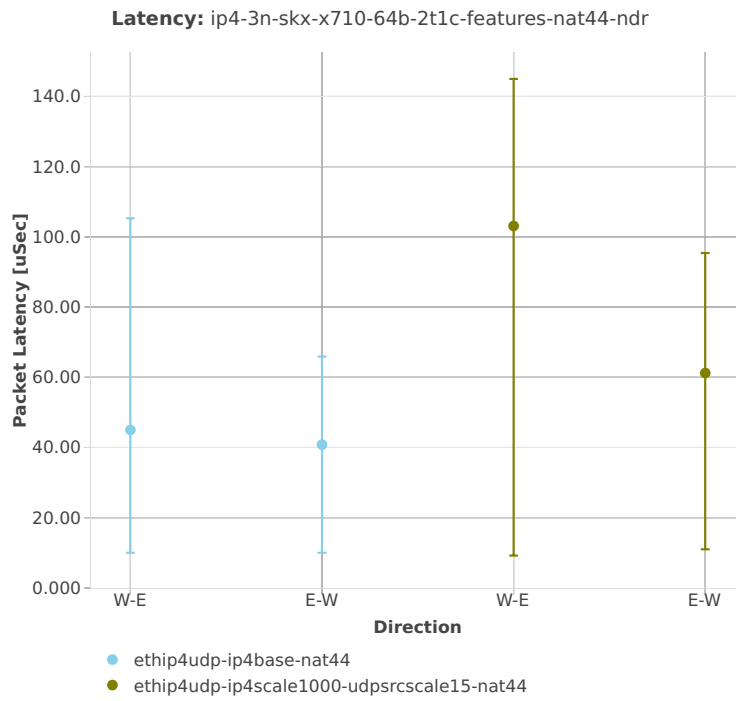

64b-4t2c-features-nat44

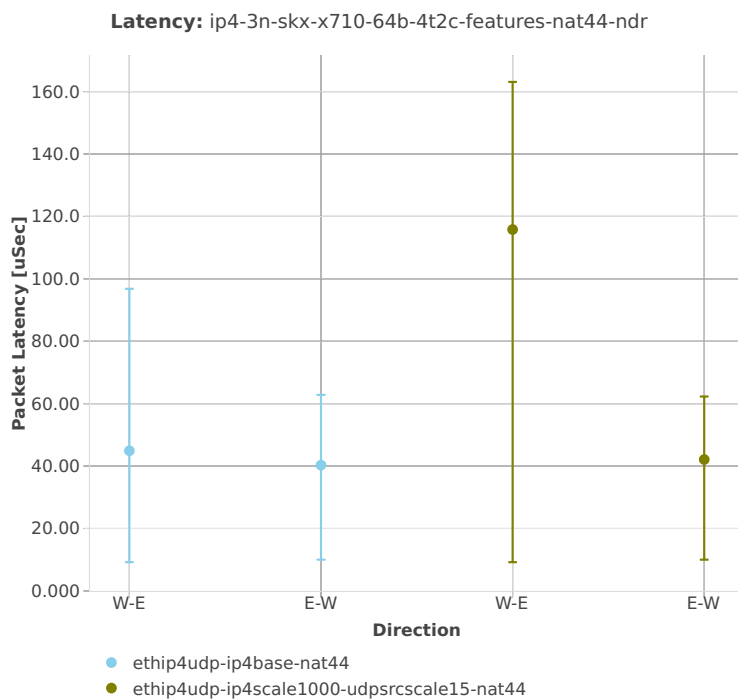

64b-2t1c-features-iacl

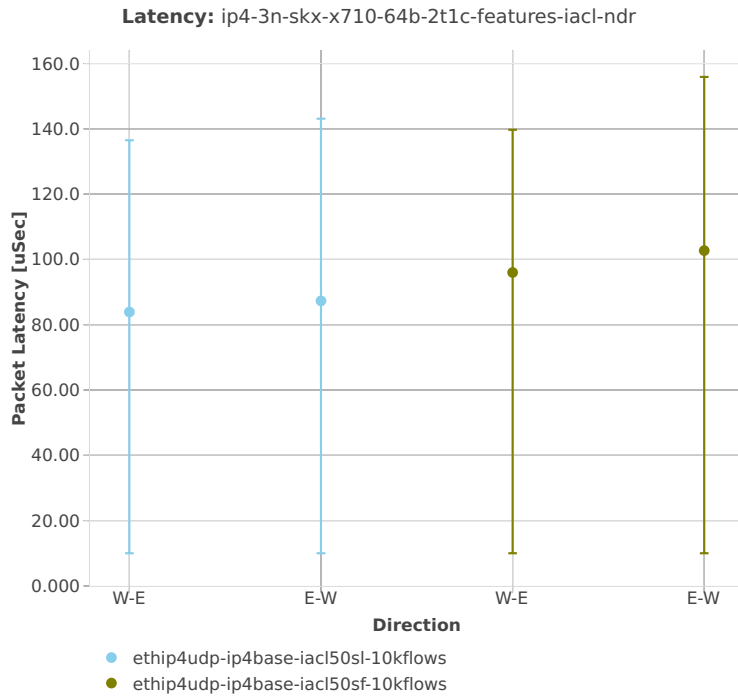

64b-4t2c-features-iacl

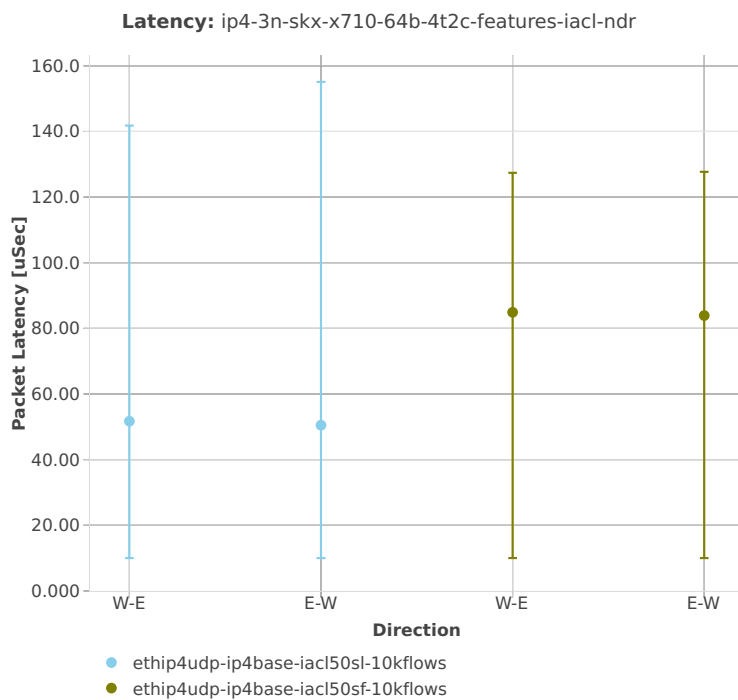

2n-skx-x710

64b-2t1c-base\_and\_scale

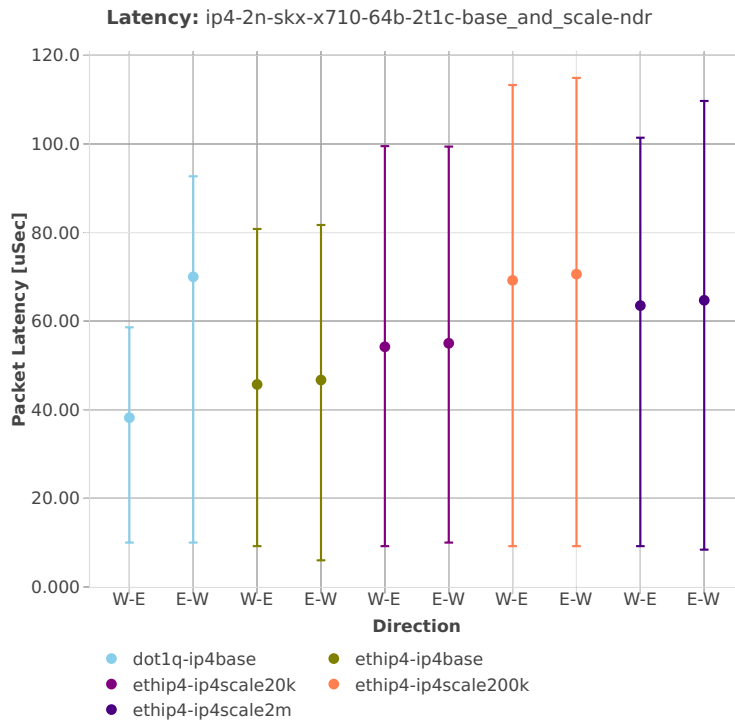

64b-4t2c-base\_and\_scale

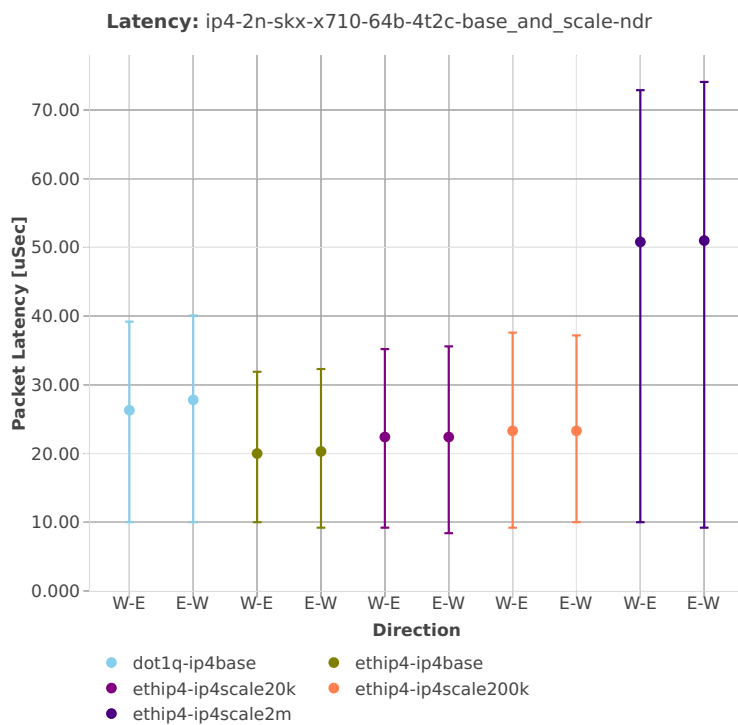

2n-skx-xxv710

64b-2t1c-base\_and\_scale

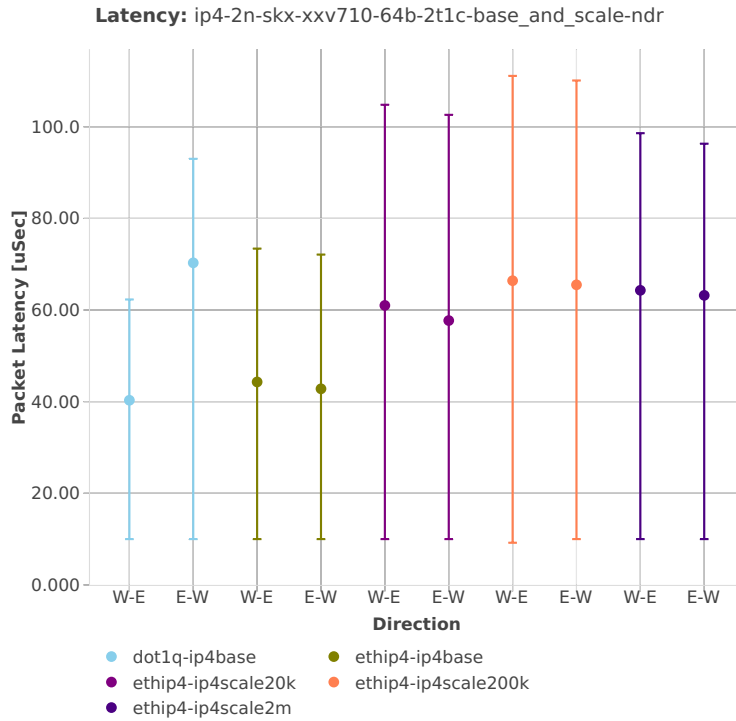



64b-4t2c-base\_and\_scale

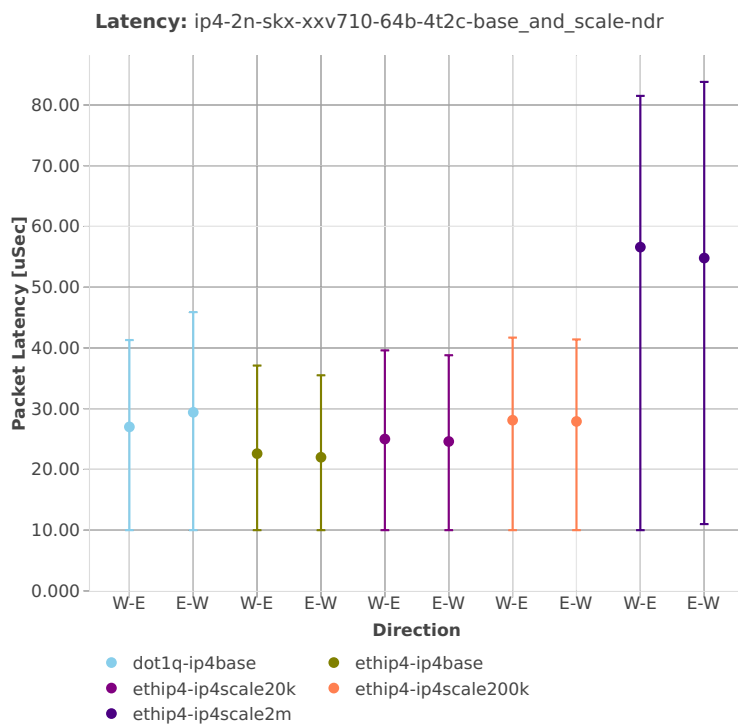

### 2.5.3 IPv6 Routing

This section includes summary graphs of VPP Phy-to-Phy packet latency with IPv6 Routed-Forwarding measured at 100% of discovered NDR throughput rate. Latency is reported for VPP running in multiple configurations of VPP worker thread(s), a.k.a. VPP data plane thread(s), and their physical CPU core(s) placement.

CSIT source code for the test cases used for plots can be found in [CSIT git repository](#)<sup>70</sup>.

---

<sup>70</sup> <https://git.fd.io/csit/tree/tests/vpp/perf/ip6?h=rls1901>

3n-hsw-x520

78b-1t1c-base\_and\_scale

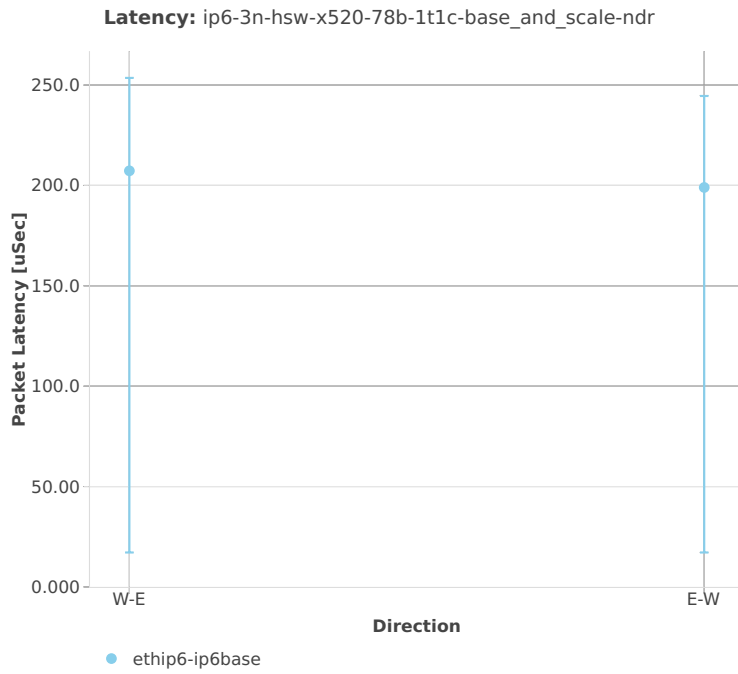

78b-2t2c-base\_and\_scale

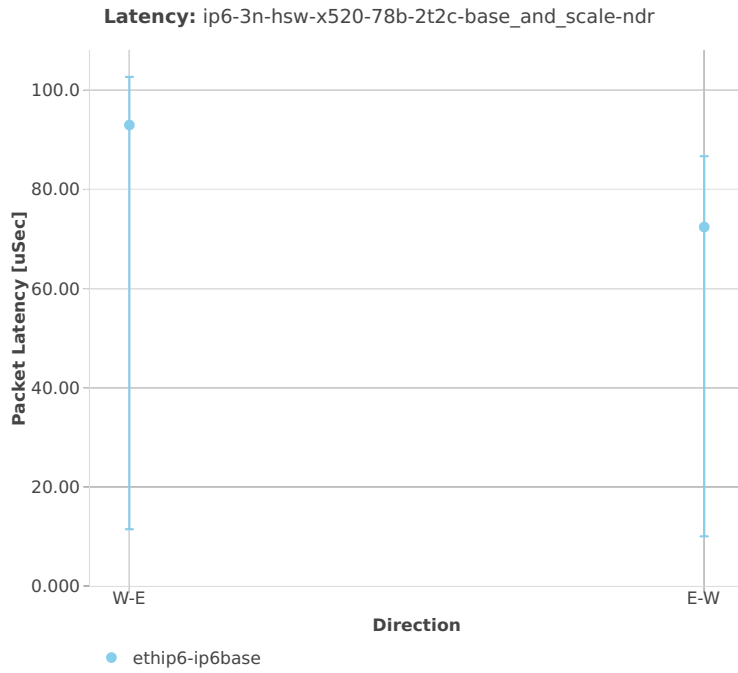

3n-hsw-x710

78b-1t1c-base\_and\_scale

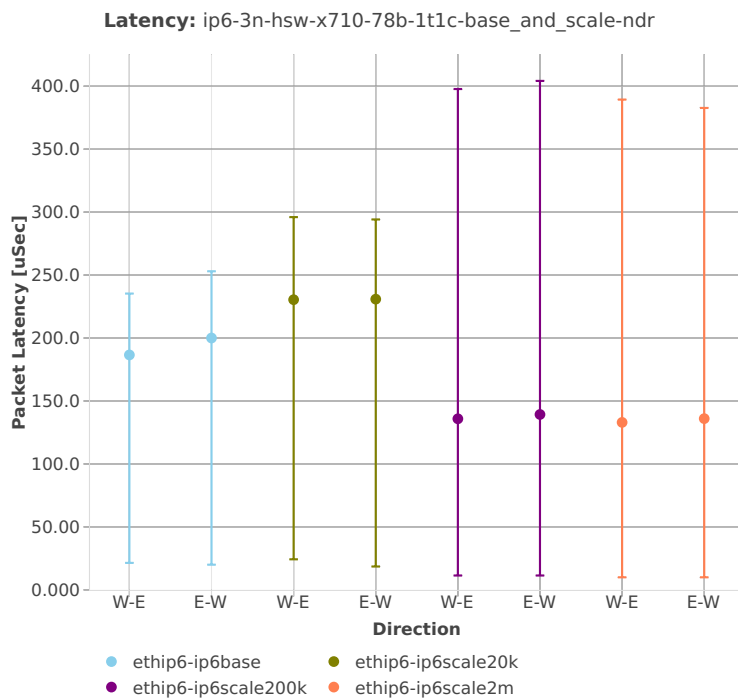

78b-2t2c-base\_and\_scale

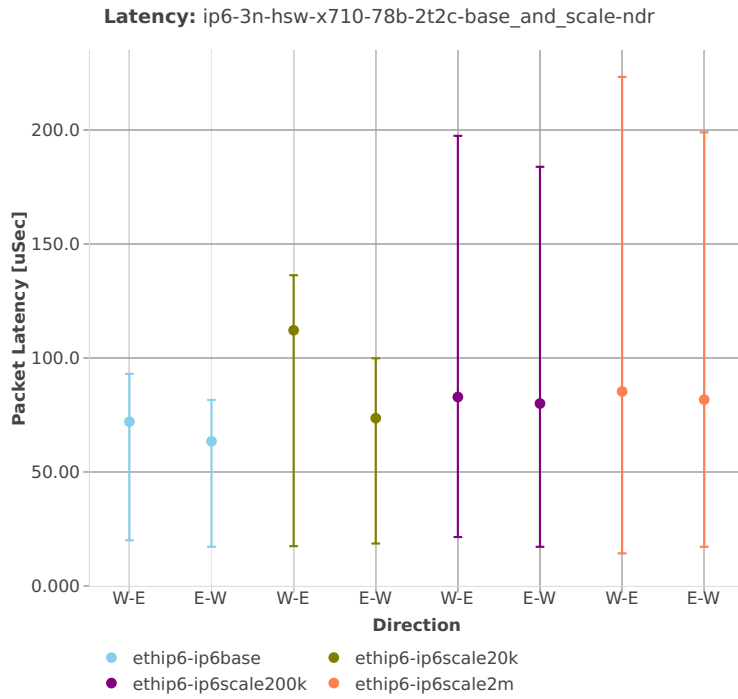

3n-hsw-xl710

78b-1t1c-base\_and\_scale

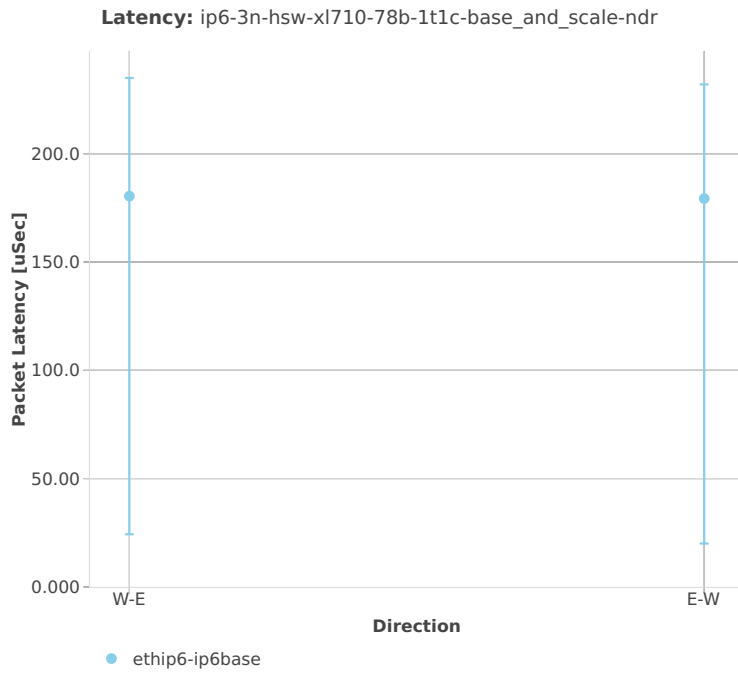

78b-2t2c-base\_and\_scale

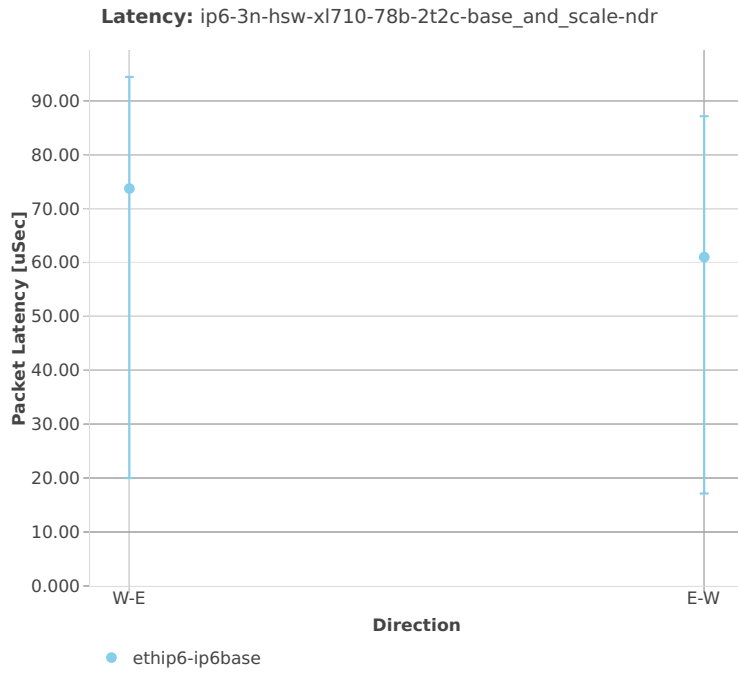



3n-skx-x710

78b-2t1c-base\_and\_scale

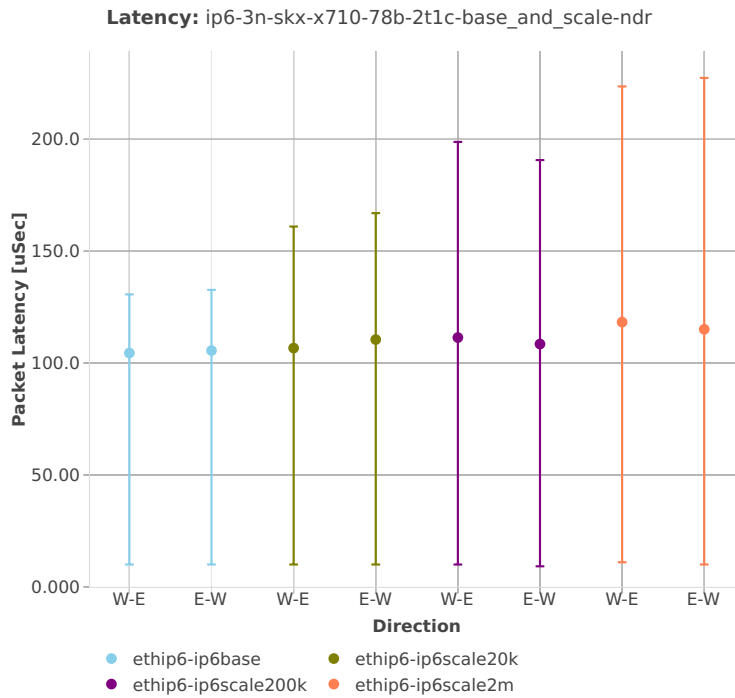

78b-4t2c-base\_and\_scale

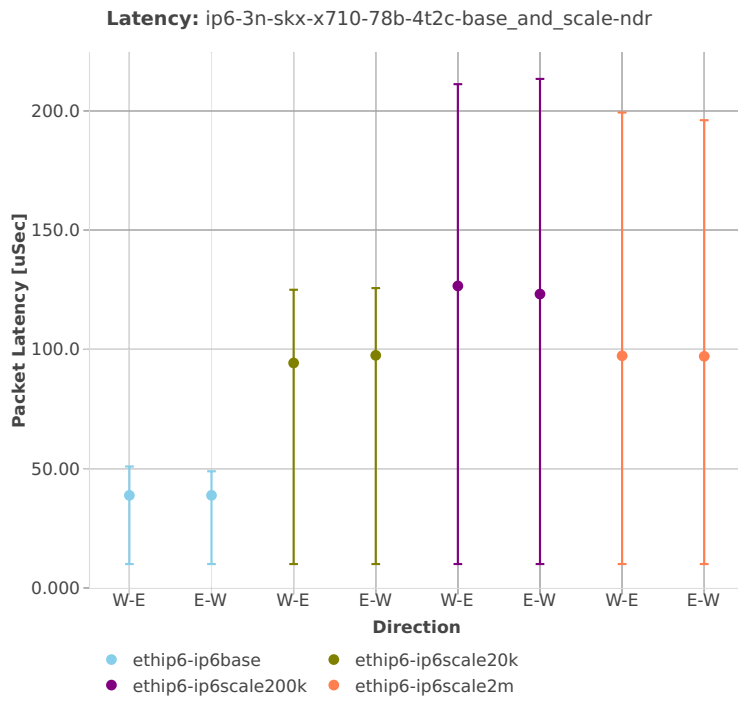

2n-skx-x710

78b-2t1c-base\_and\_scale

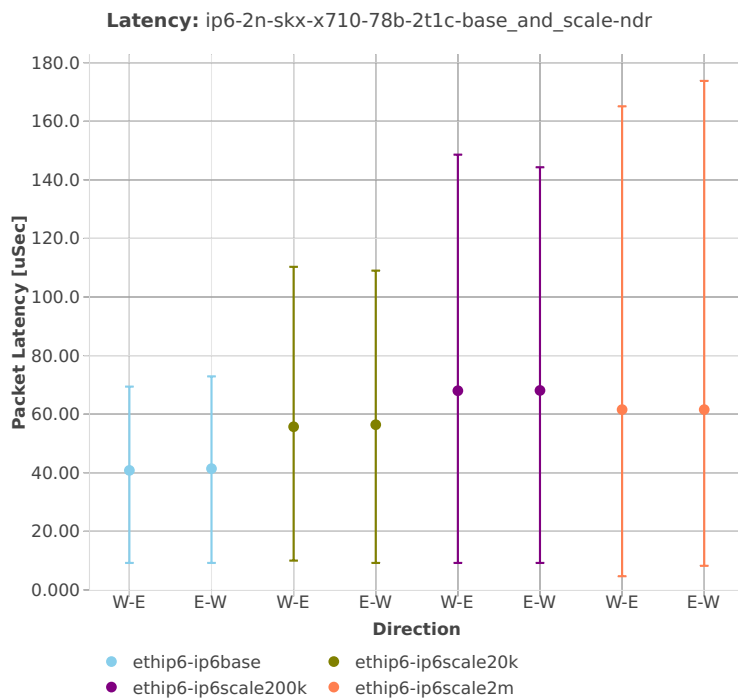

78b-4t2c-base\_and\_scale

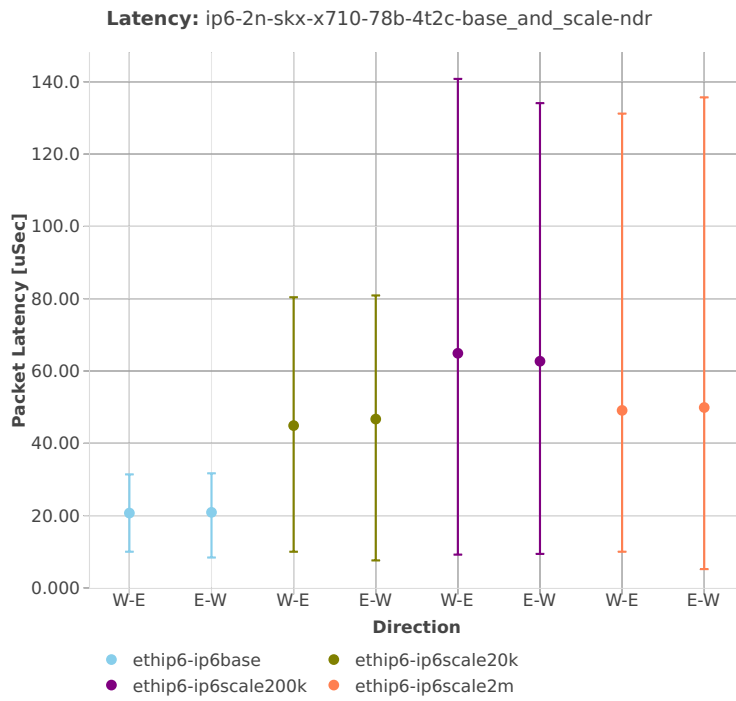

2n-skx-xxv710

78b-2t1c-base\_and\_scale

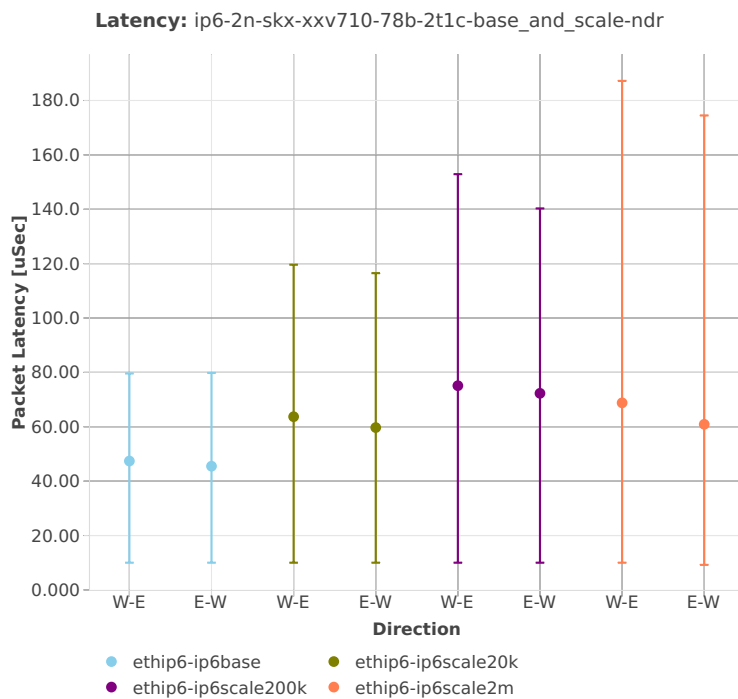

78b-4t2c-base\_and\_scale

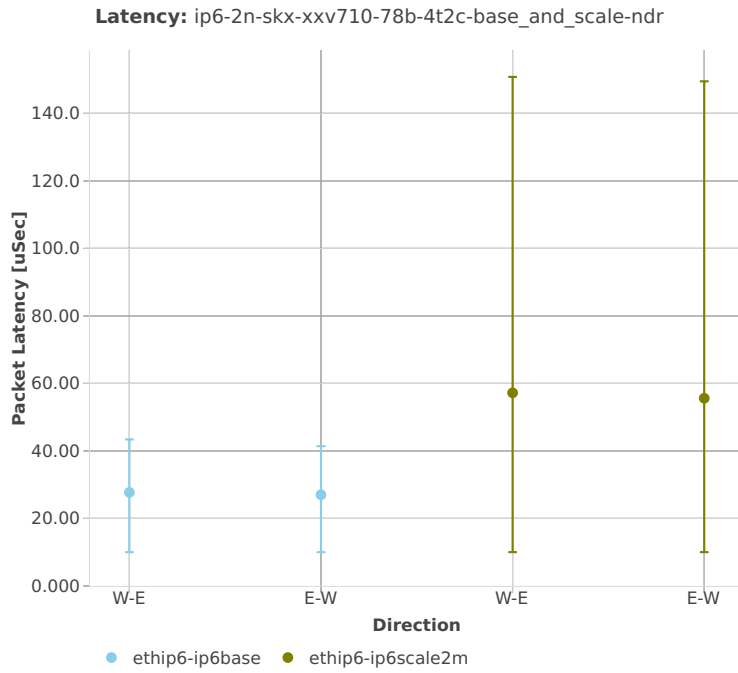

## 2.5.4 SRv6 Routing

This section includes summary graphs of VPP Phy-to-Phy packet latency with SRv6 measured at 100% of discovered NDR throughput rate. Latency is reported for VPP running in multiple configurations of VPP worker thread(s), a.k.a. VPP data plane thread(s), and their physical CPU core(s) placement.

CSIT source code for the test cases used for plots can be found in [CSIT git repository](#)<sup>71</sup>.

---

<sup>71</sup> <https://git.fd.io/csit/tree/tests/vpp/perf/srv6?h=rls1901>

3n-hsw-x520

78b-1t1c-features

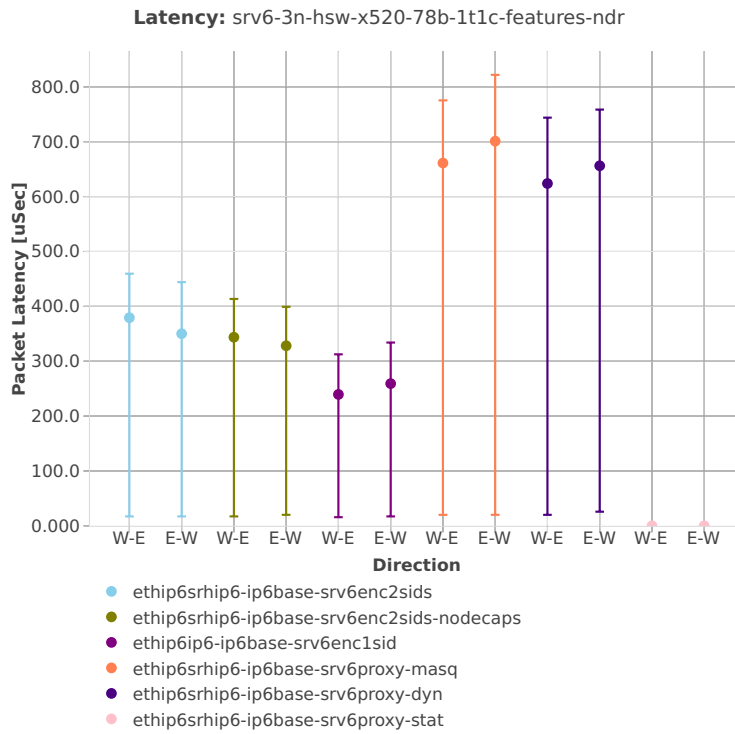



78b-2t2c-features

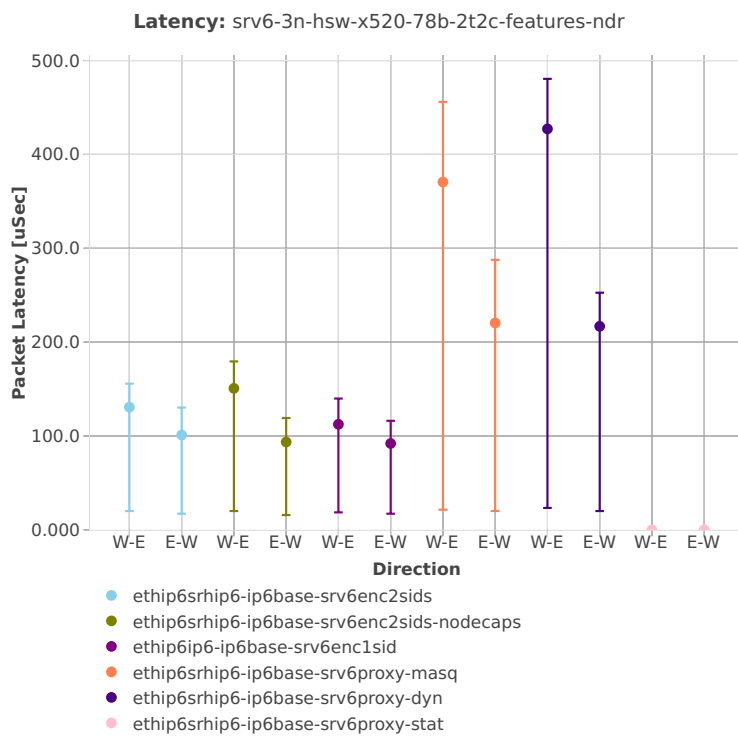

### 2.5.5 IPv4 Tunnels

This section includes summary graphs of VPP Phy-to-Phy packet latency with IPv4 Overlay Tunnels measured at 100% of discovered NDR throughput rate. Latency is reported for VPP running in multiple configurations of VPP worker thread(s), a.k.a. VPP data plane thread(s), and their physical CPU core(s) placement.

CSIT source code for the test cases used for plots can be found in [CSIT git repository](#)<sup>72</sup>.

---

<sup>72</sup> [https://git.fd.io/csit/tree/tests/vpp/perf/ip4\\_tunnels?h=rls1901](https://git.fd.io/csit/tree/tests/vpp/perf/ip4_tunnels?h=rls1901)

3n-hsw-x520

64b-1t1c-base\_and\_features

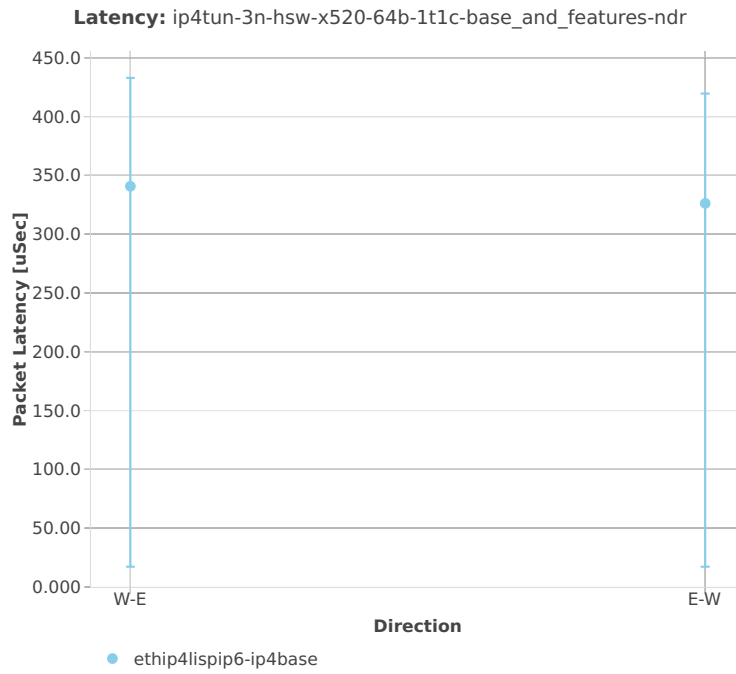

64b-2t2c-base\_and\_features

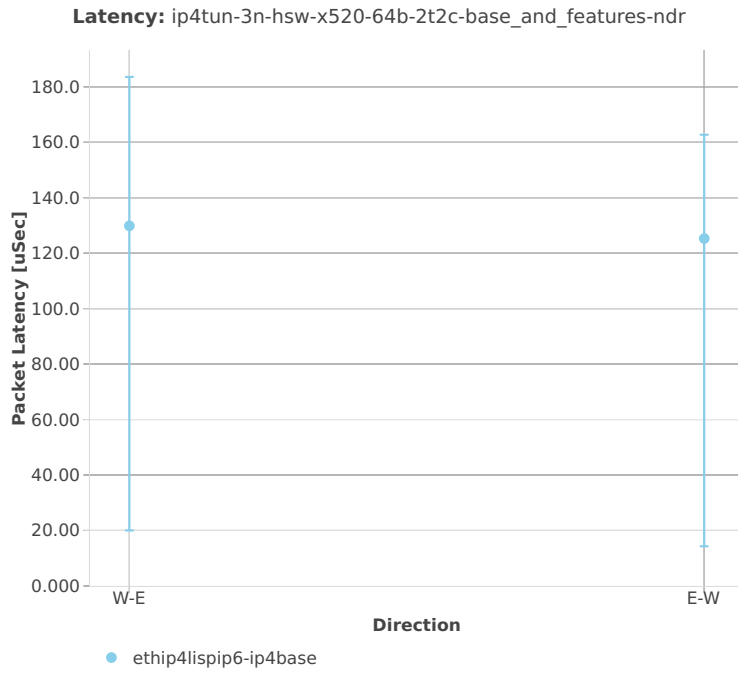

3n-hsw-x710

64b-1t1c-base\_and\_scale

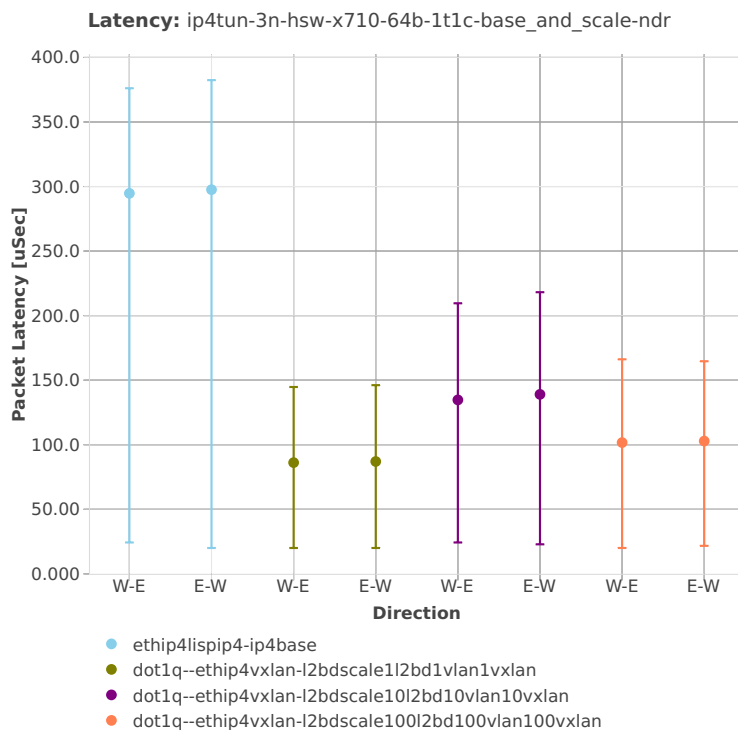

64b-2t2c-base\_and\_scale

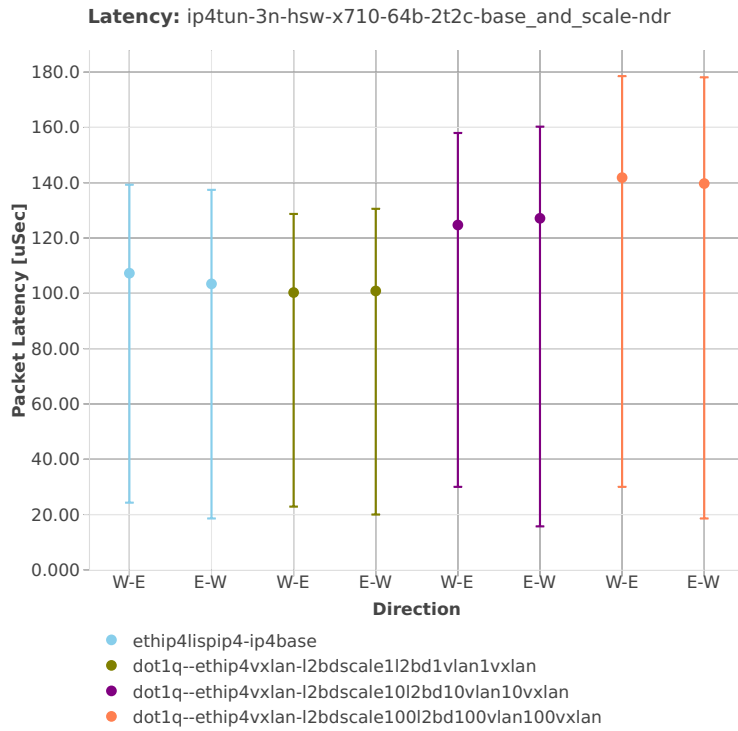

64b-1t1c-base\_and\_features

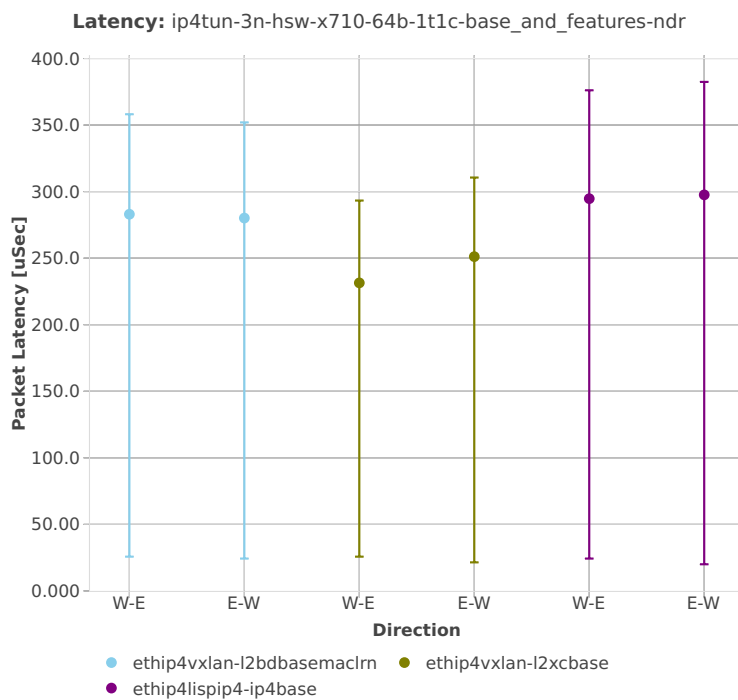

64b-2t2c-base\_and\_features

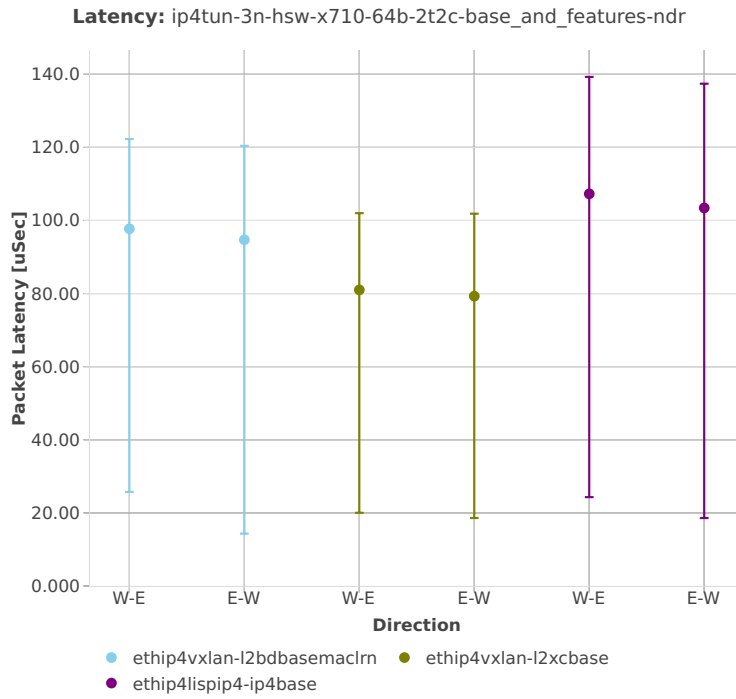



3n-skx-x710

64b-2t1c-base\_and\_scale

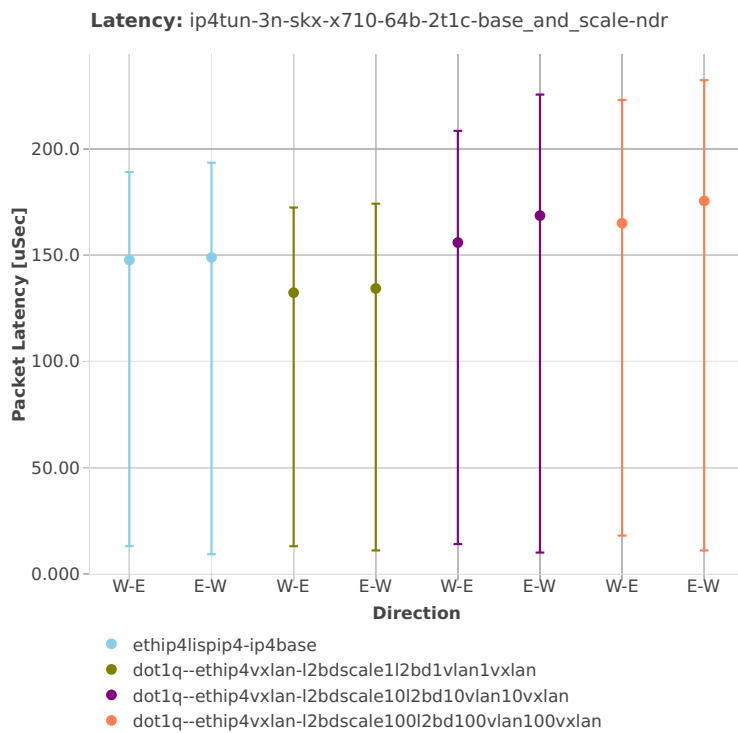

64b-4t2c-base\_and\_scale

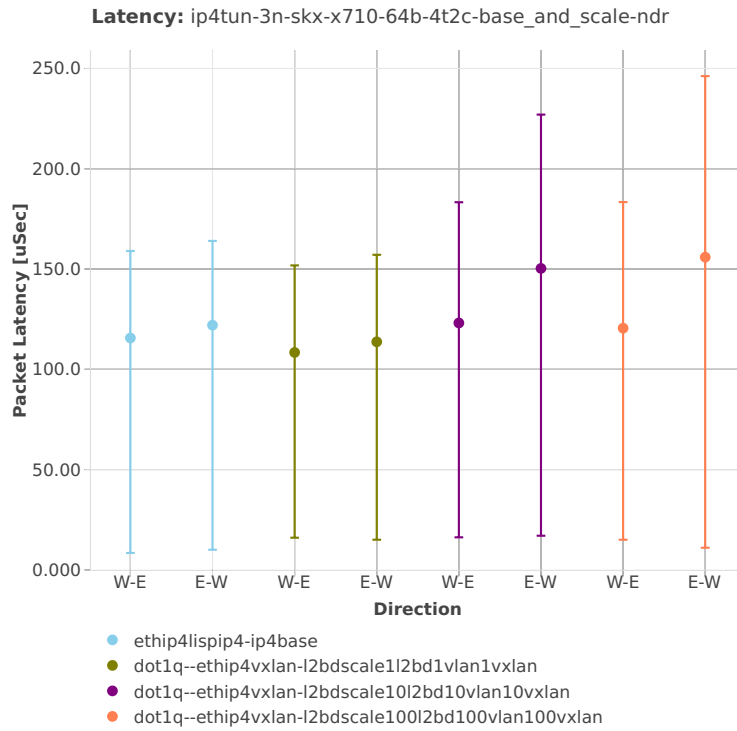

64b-2t1c-base\_and\_features

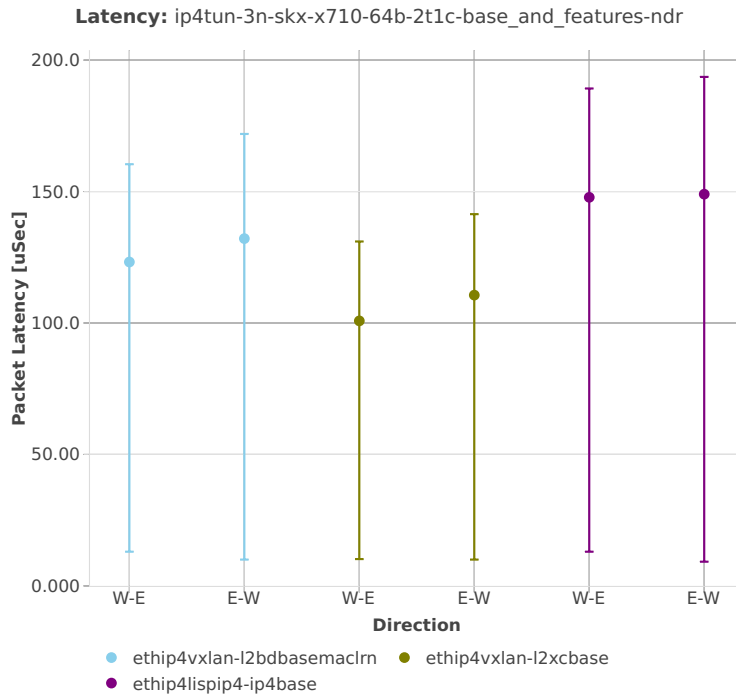

64b-4t2c-base\_and\_features

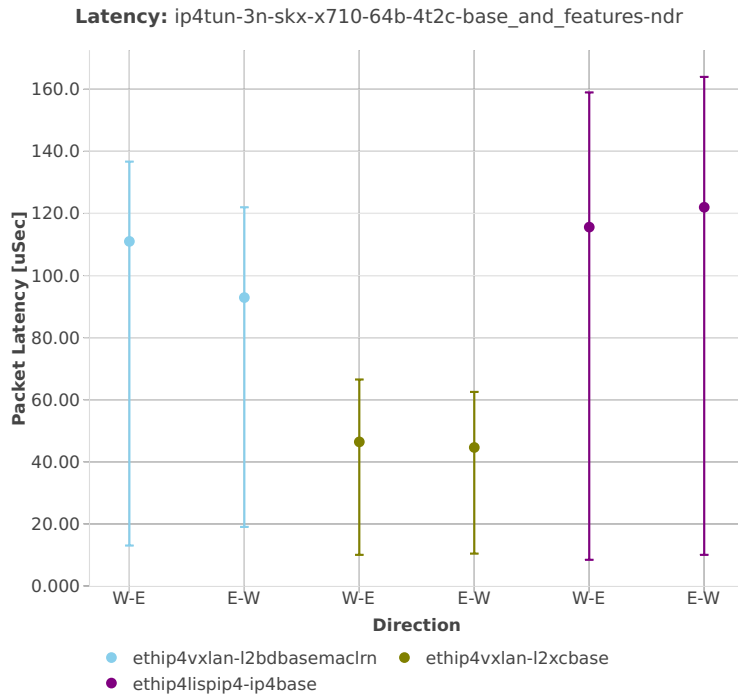

## 2.5.6 IPv6 Tunnels

This section includes summary graphs of VPP Phy-to-Phy packet latency with IPv6 Overlay Tunnels measured at 100% of discovered NDR throughput rate. Latency is reported for VPP running in multiple configurations of VPP worker thread(s), a.k.a. VPP data plane thread(s), and their physical CPU core(s) placement.

CSIT source code for the test cases used for plots can be found in [CSIT git repository](#)<sup>73</sup>.

---

<sup>73</sup> [https://git.fd.io/csit/tree/tests/vpp/perf/ip6\\_tunnels?h=rls1901](https://git.fd.io/csit/tree/tests/vpp/perf/ip6_tunnels?h=rls1901)

3n-hsw-x520

78b-1t1c-base\_and\_scale

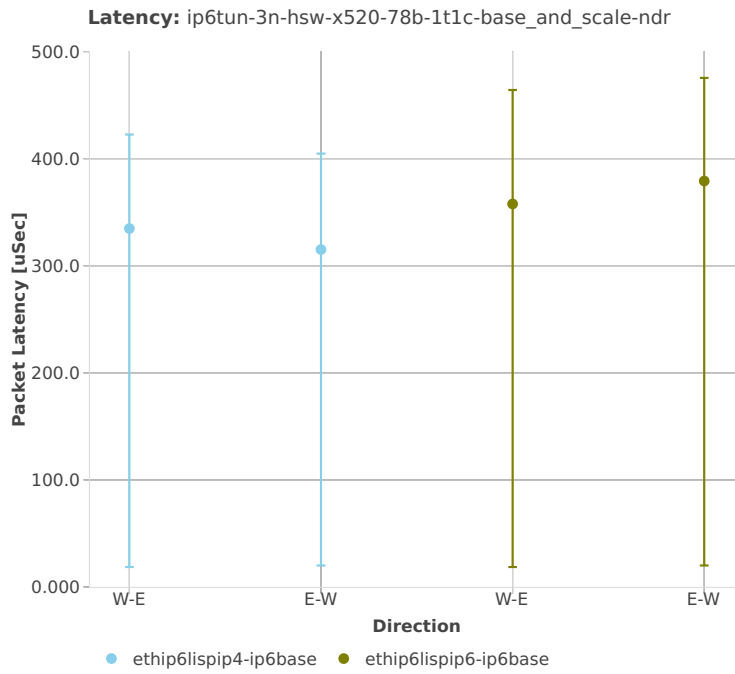

78b-2t2c-base\_and\_scale

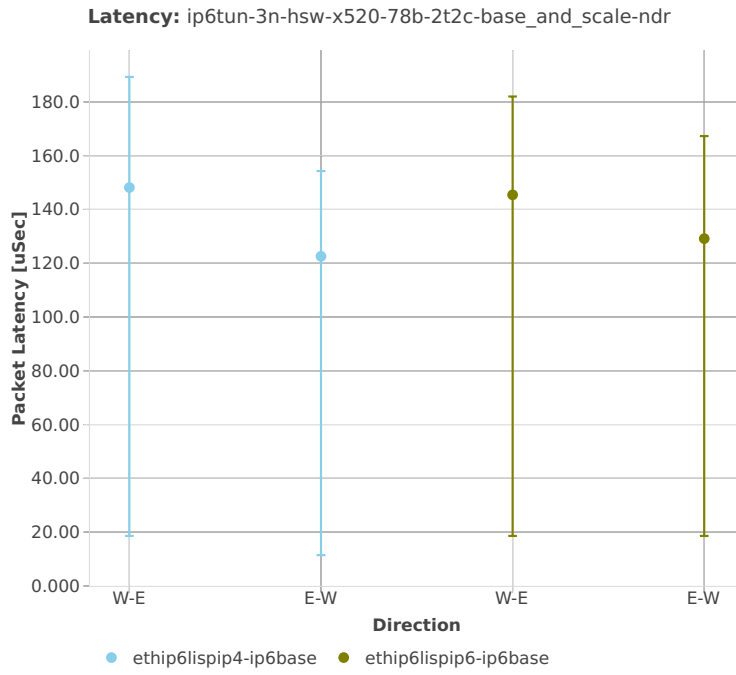

### 2.5.7 KVM VMs vhost-user

This section includes summary graphs of VPP Phy-to-VM(s)-to-Phy packet latency with with VM virtio and VPP vhost-user virtual interfaces measured at 100% of discovered NDR throughput rate. Latency is reported for VPP running in multiple configurations of VPP worker thread(s), a.k.a. VPP data plane thread(s), and their physical CPU core(s) placement.

CSIT source code for the test cases used for plots can be found in [CSIT git repository](#)<sup>74</sup>.

---

<sup>74</sup> [https://git.fd.io/csit/tree/tests/vpp/perf/vm\\_vhost?h=rls1901](https://git.fd.io/csit/tree/tests/vpp/perf/vm_vhost?h=rls1901)



3n-hsw-x520

64b-1t1c-base-l2sw

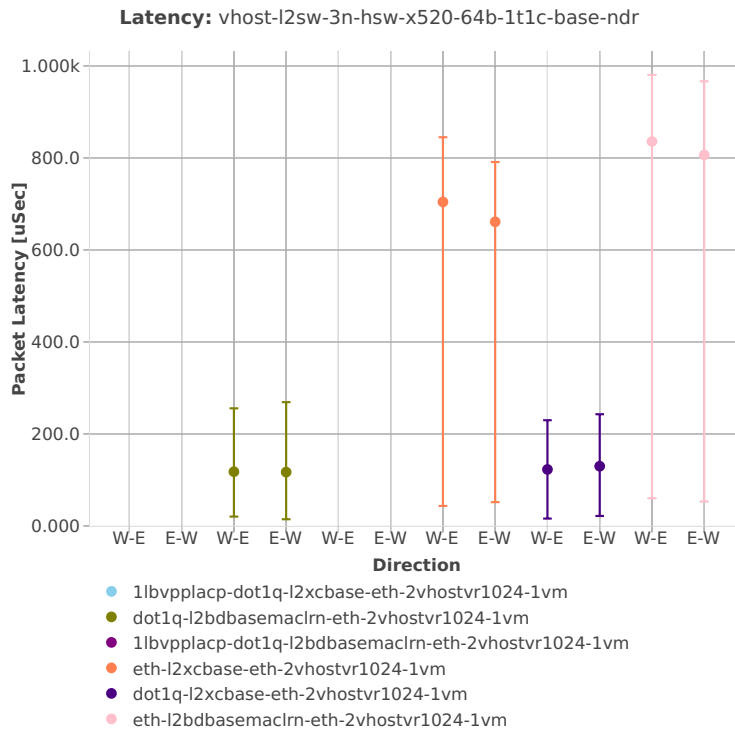

64b-2t2c-base-l2sw

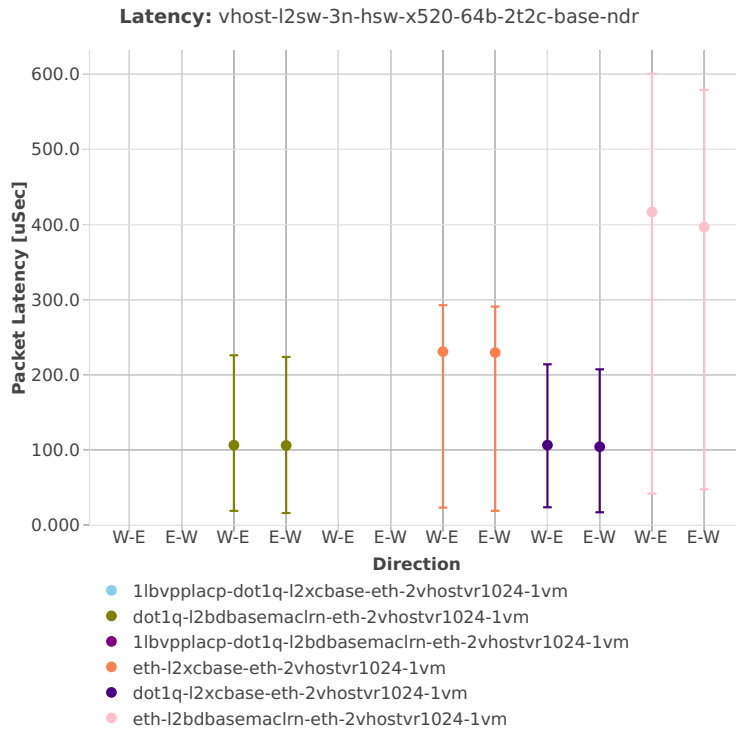

64b-1t1c-base\_and\_scale-l2sw

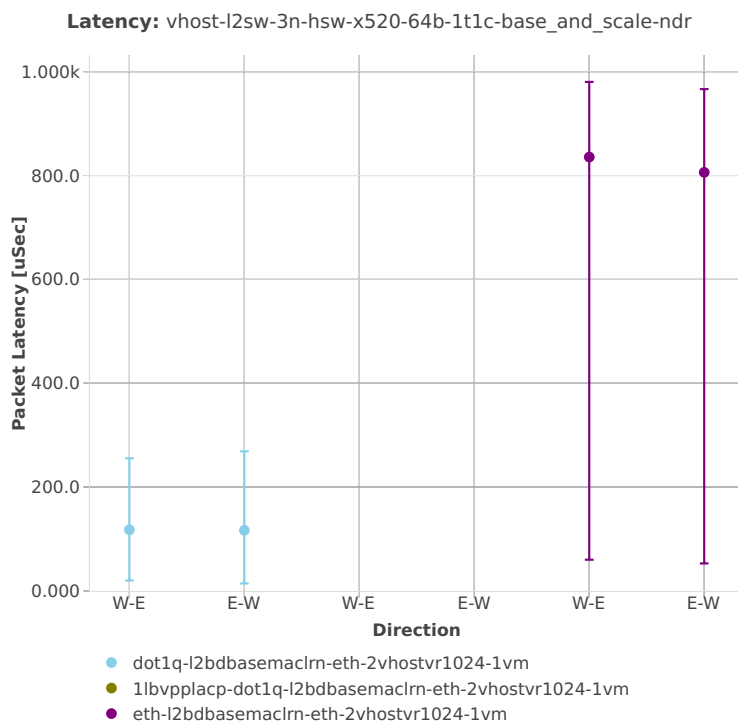

64b-2t2c-base\_and\_scale-l2sw

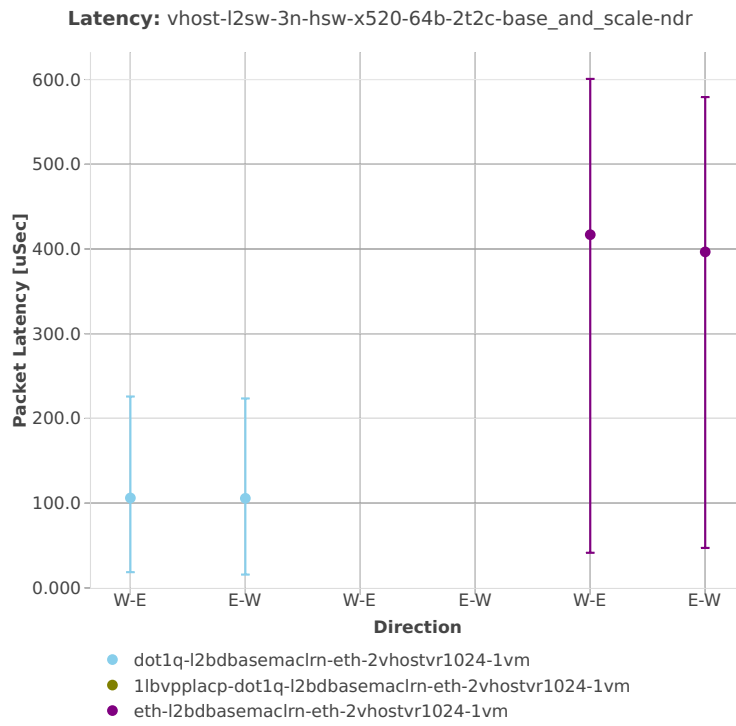

64b-1t1c-base-vm-l2sw

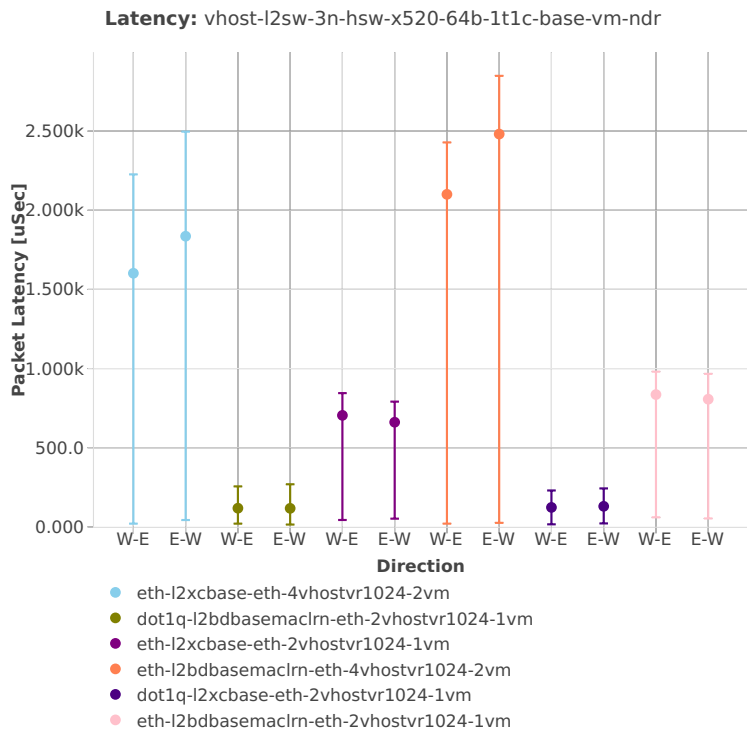

64b-2t2c-base-vm-l2sw

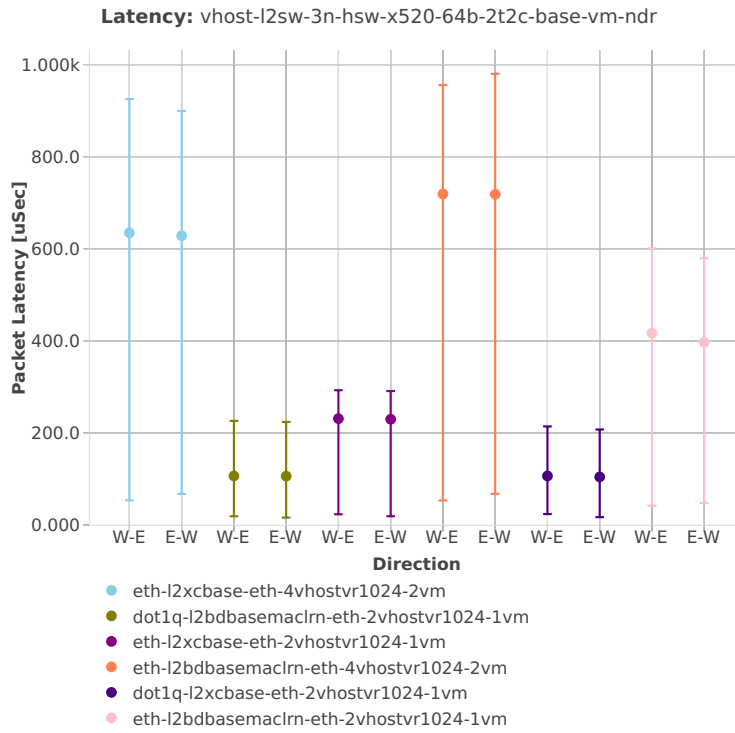

64b-1t1c-base\_and\_scale-ip4

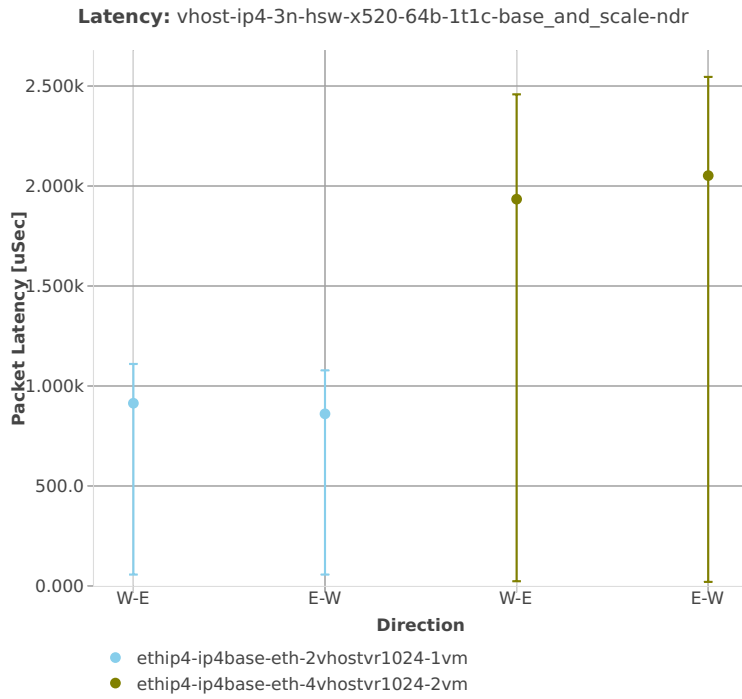

64b-2t2c-base\_and\_scale-ip4

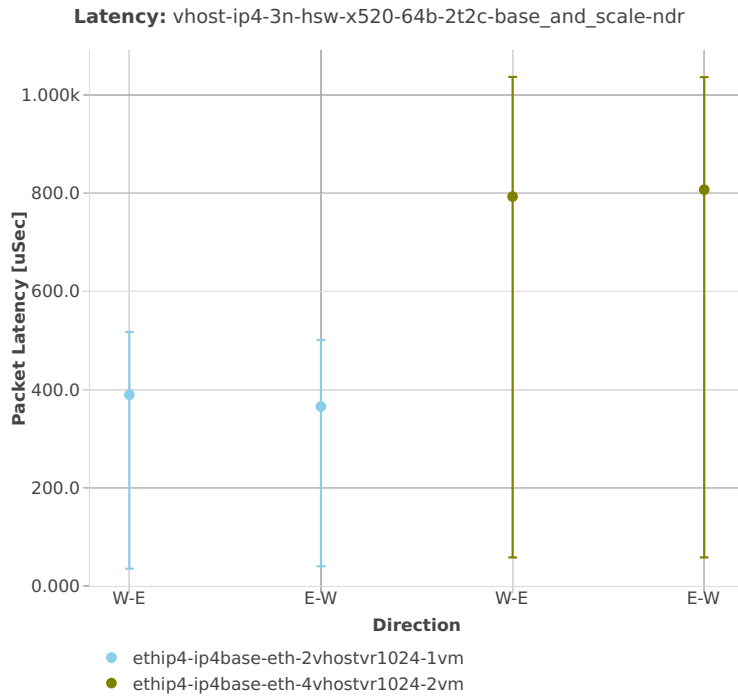



3n-hsw-x710

64b-1t1c-base-l2sw

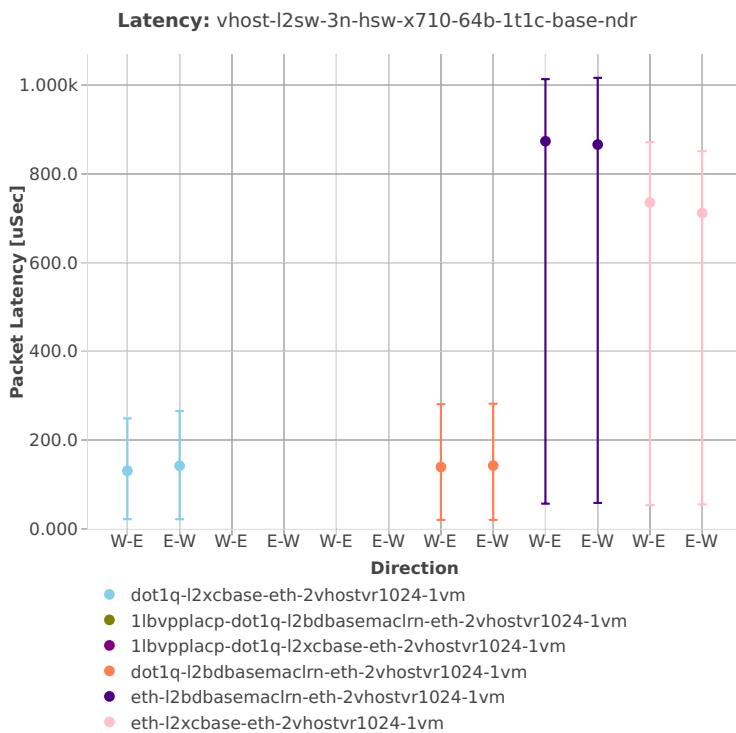

64b-2t2c-base-l2sw

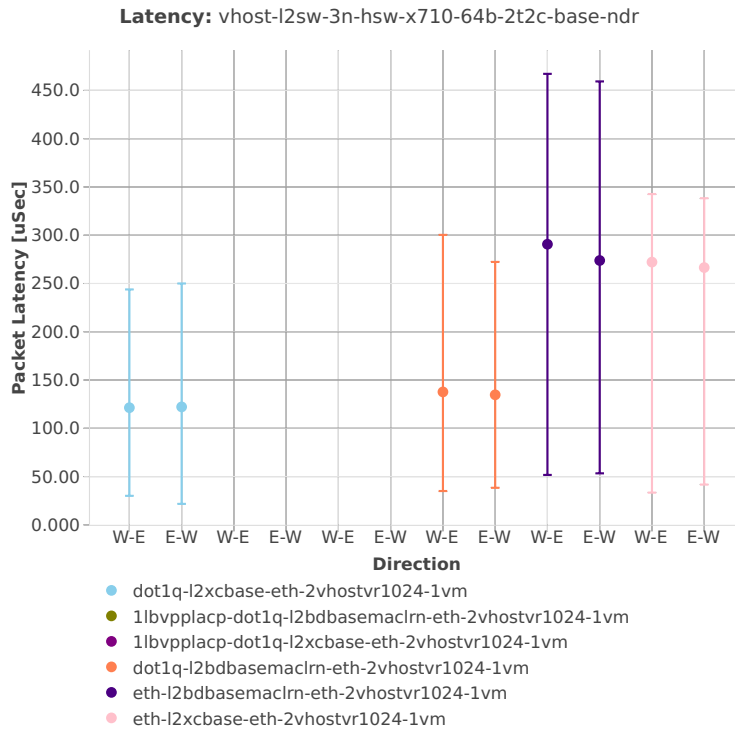

64b-1t1c-base\_and\_scale-l2sw

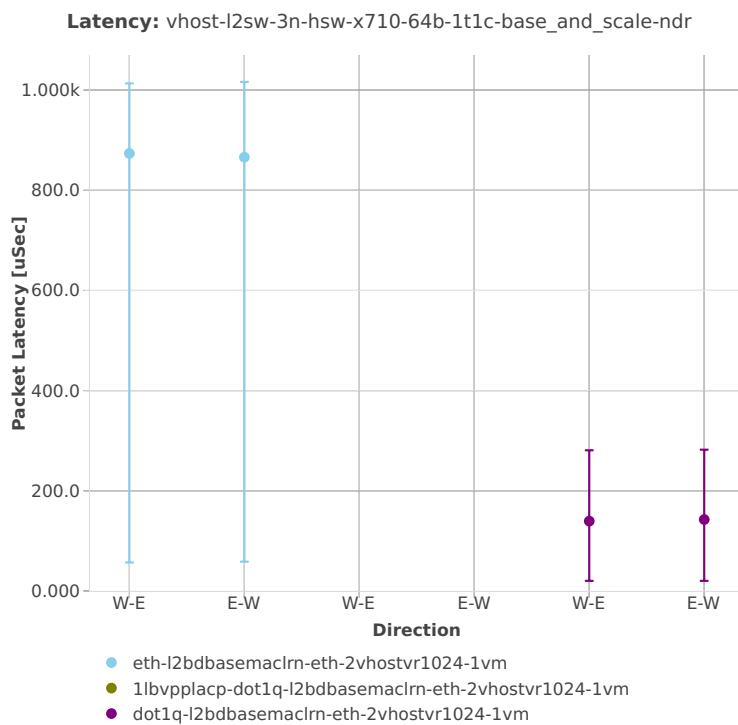

64b-2t2c-base\_and\_scale-l2sw

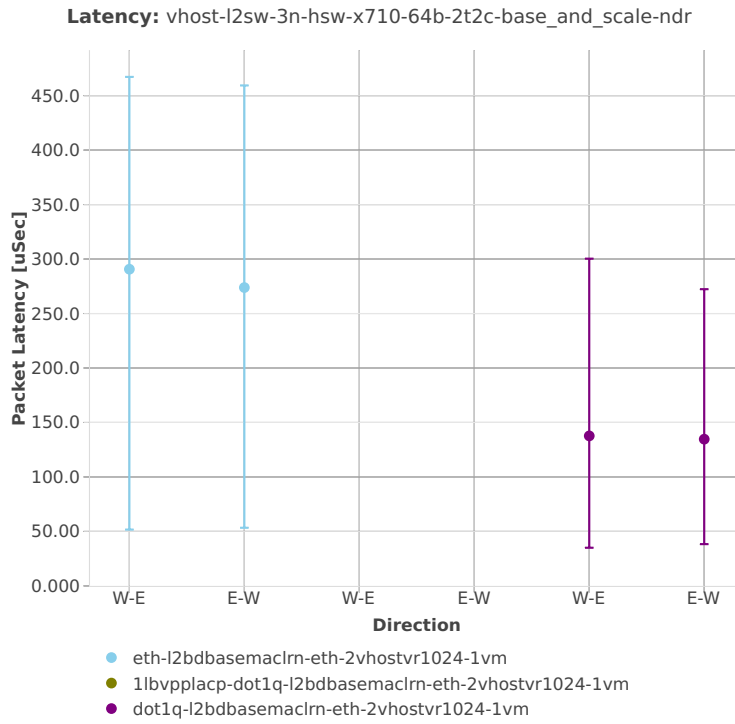

64b-1t1c-base-vm-l2sw

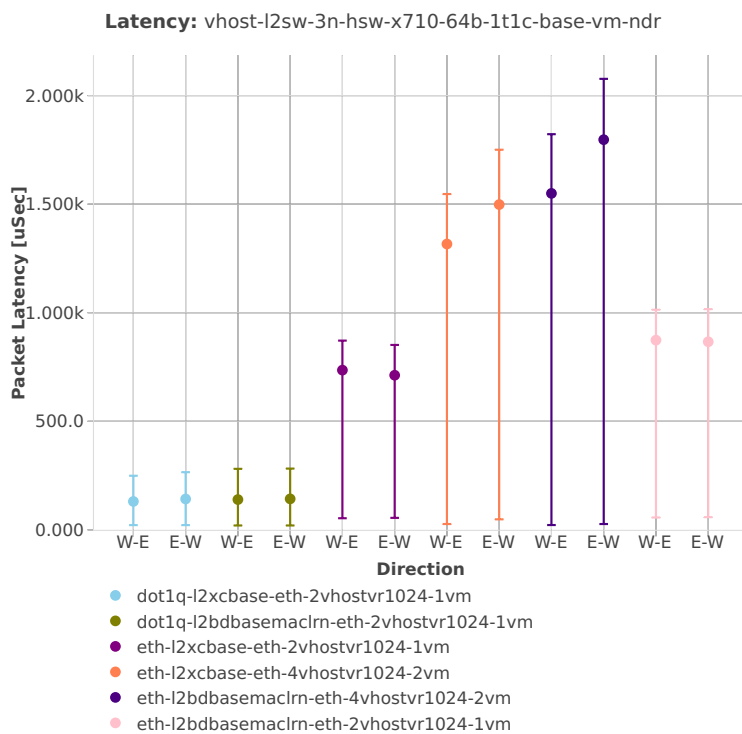

64b-2t2c-base-vm-l2sw

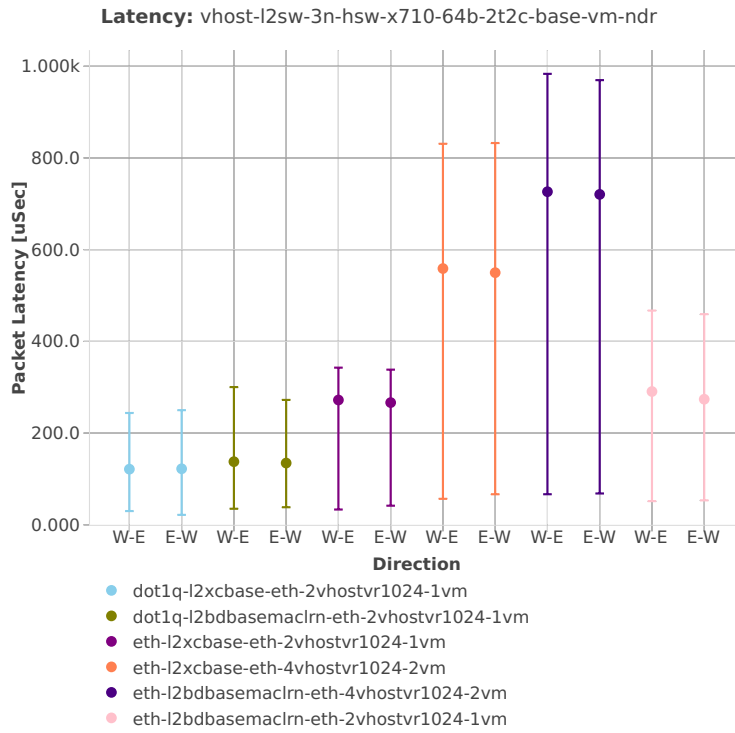

64b-1t1c-base\_and\_scale-ip4

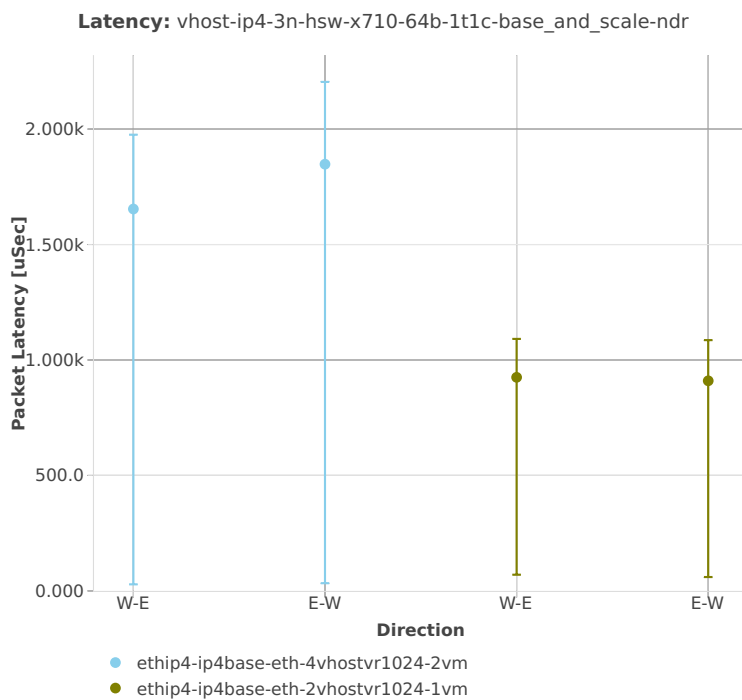

64b-2t2c-base\_and\_scale-ip4

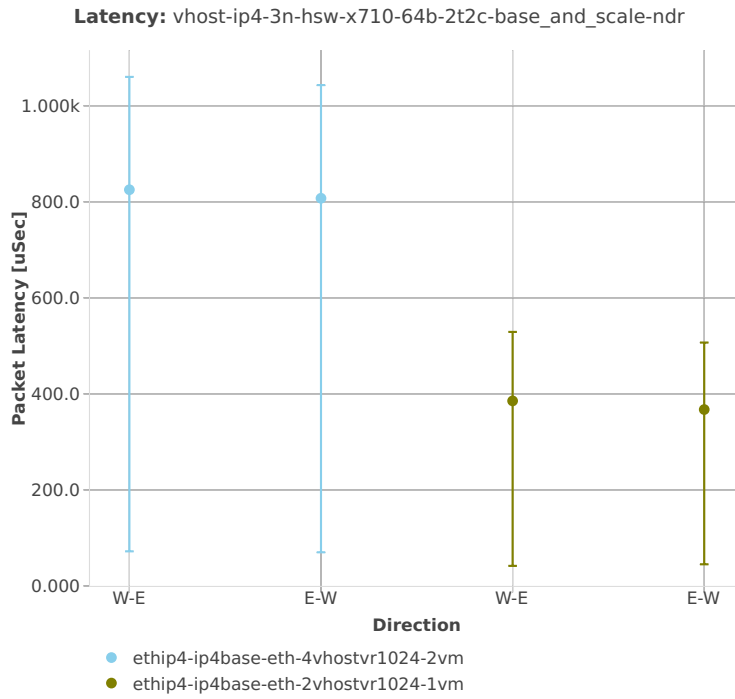



3n-skx-x710

64b-2t1c-base-l2sw

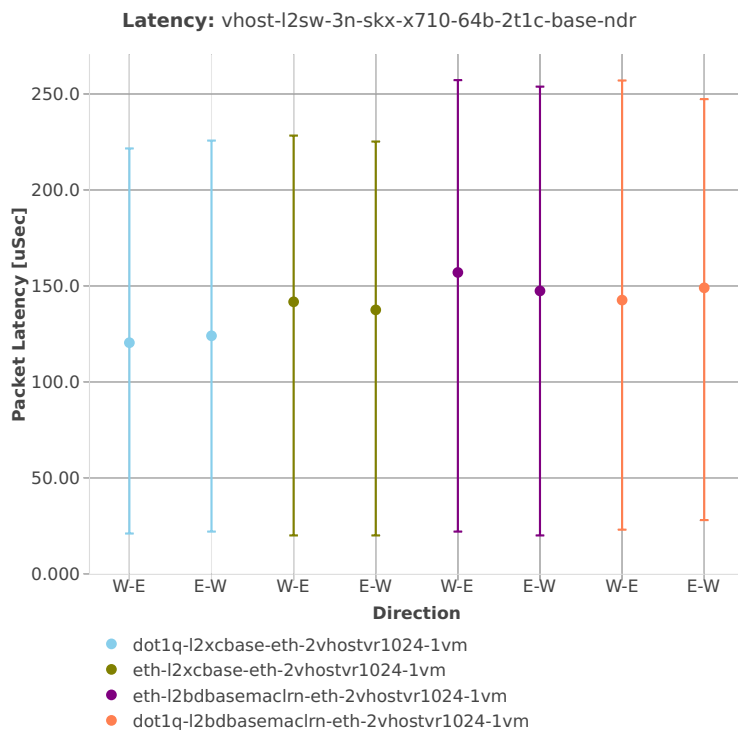

64b-4t2c-base-l2sw

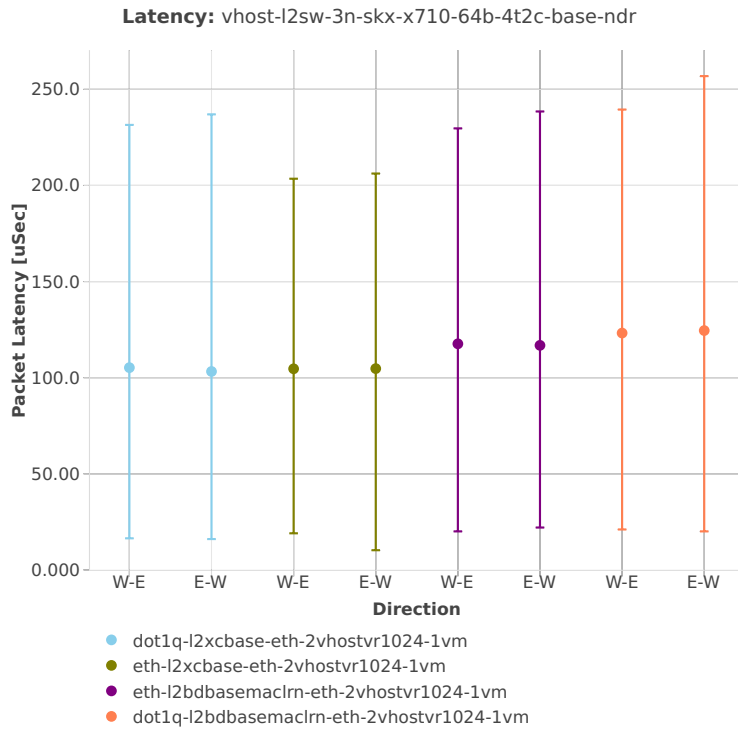

64b-2t1c-base\_and\_scale-l2sw

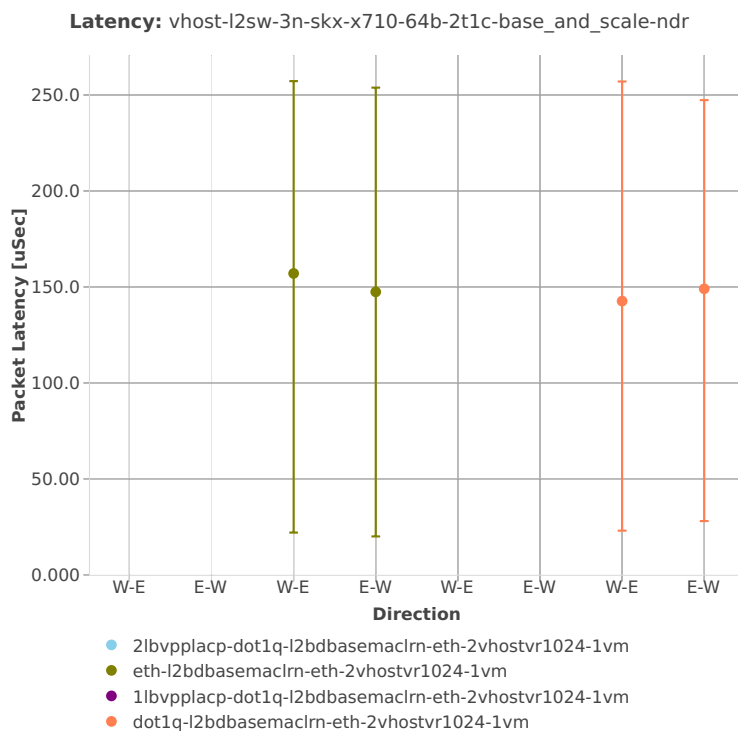

64b-4t2c-base\_and\_scale-l2sw

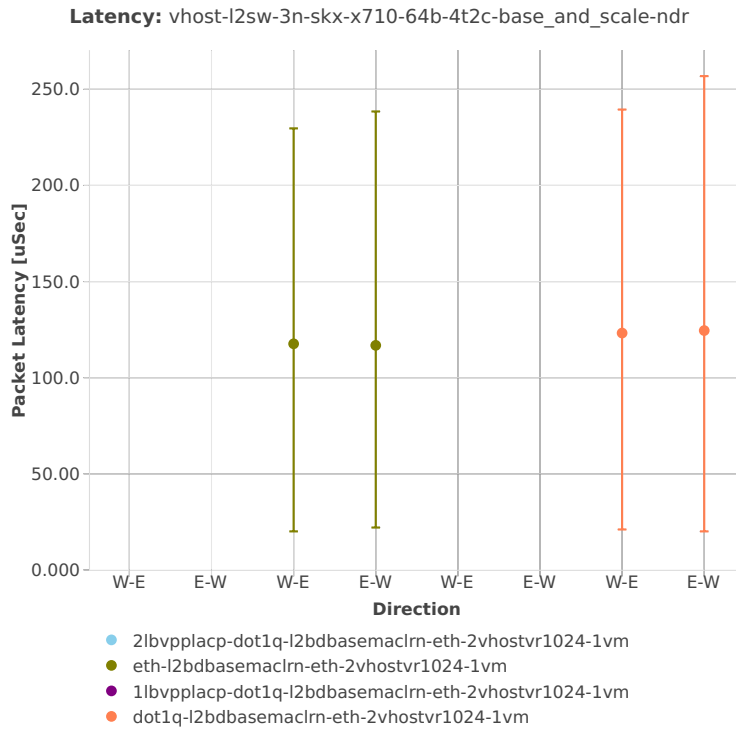

64b-2t1c-base-vm-l2sw

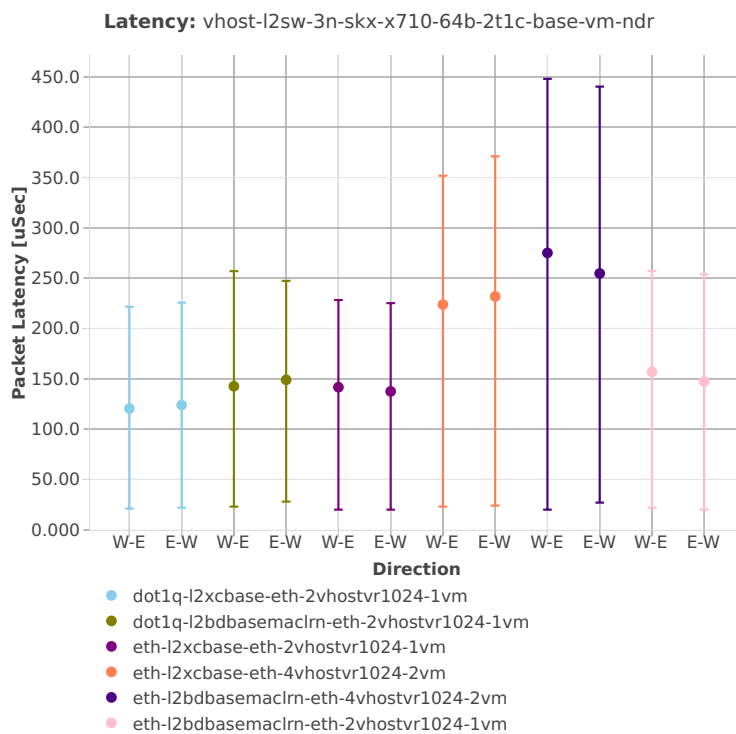

64b-4t2c-base-vm-l2sw

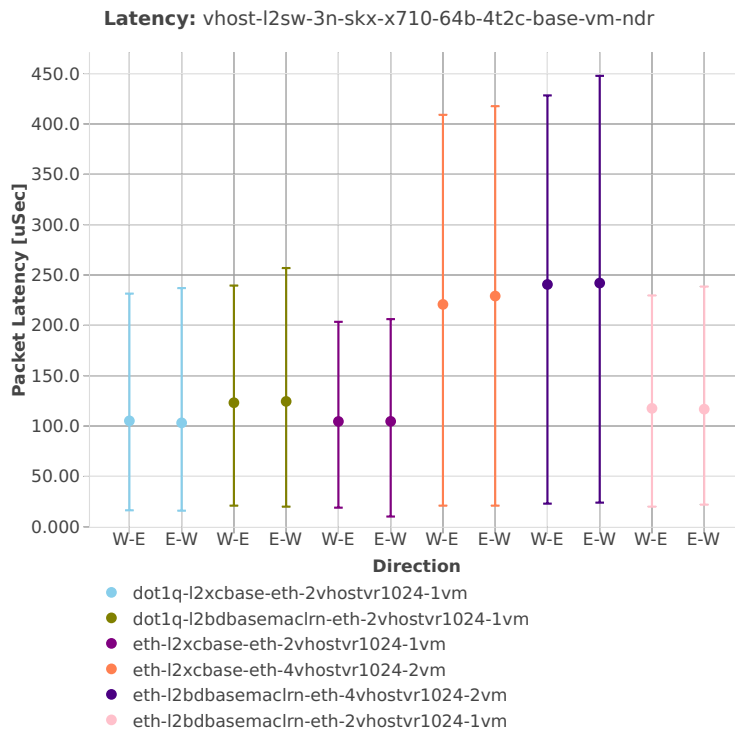

64b-2t1c-base\_and\_scale-ip4

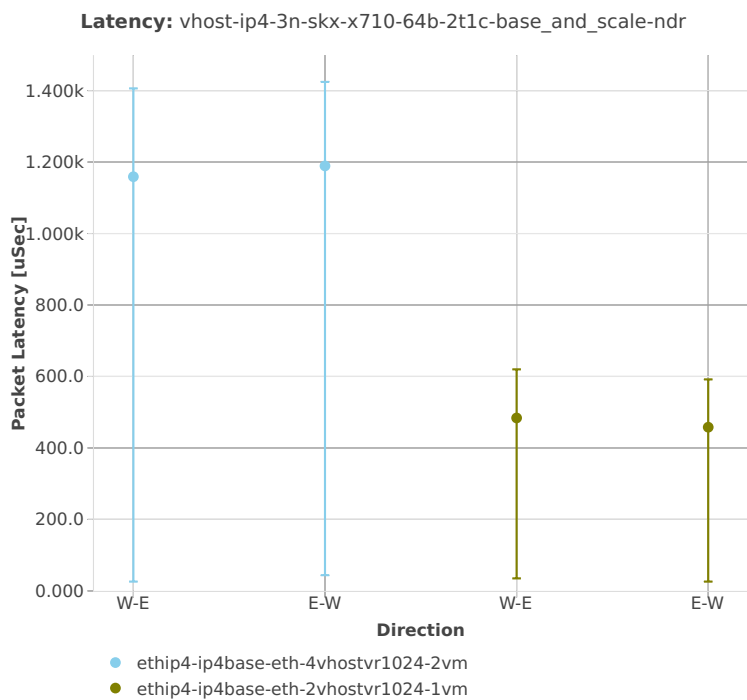

64b-4t2c-base\_and\_scale-ip4

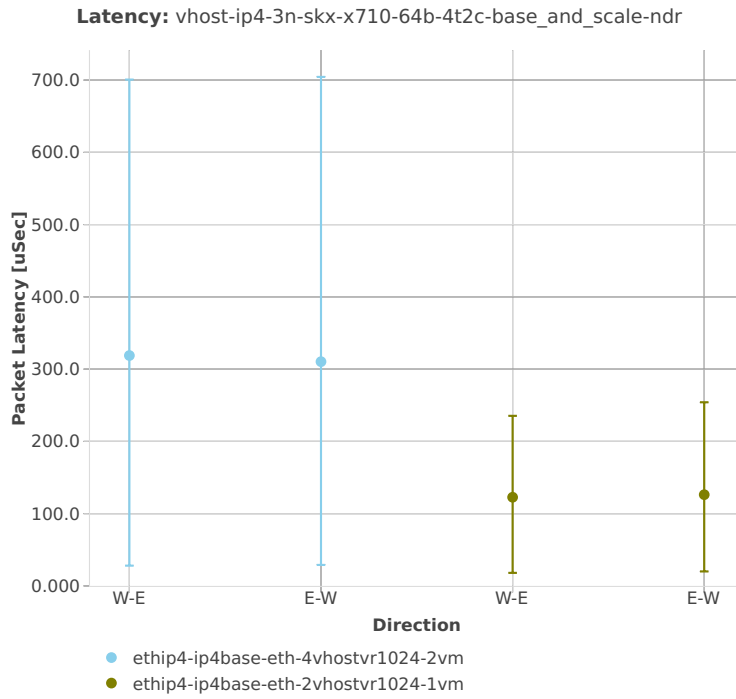



2n-skx-x710

64b-2t1c-base-l2sw

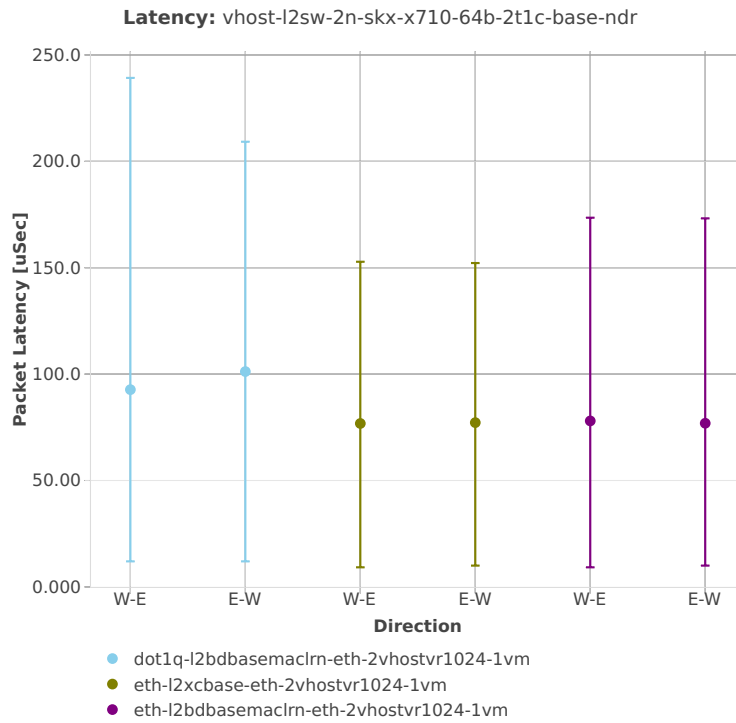

64b-4t2c-base-l2sw

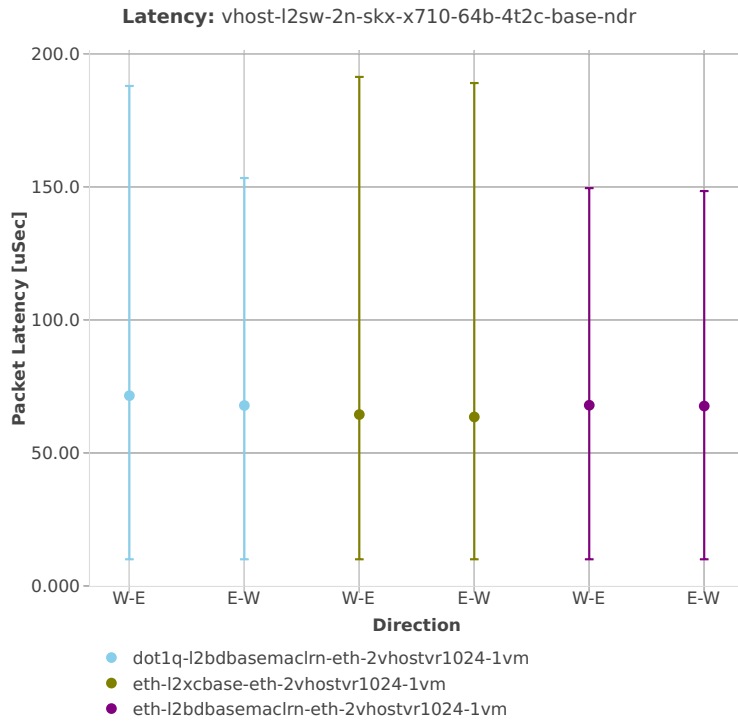

64b-2t1c-base\_and\_scale-l2sw

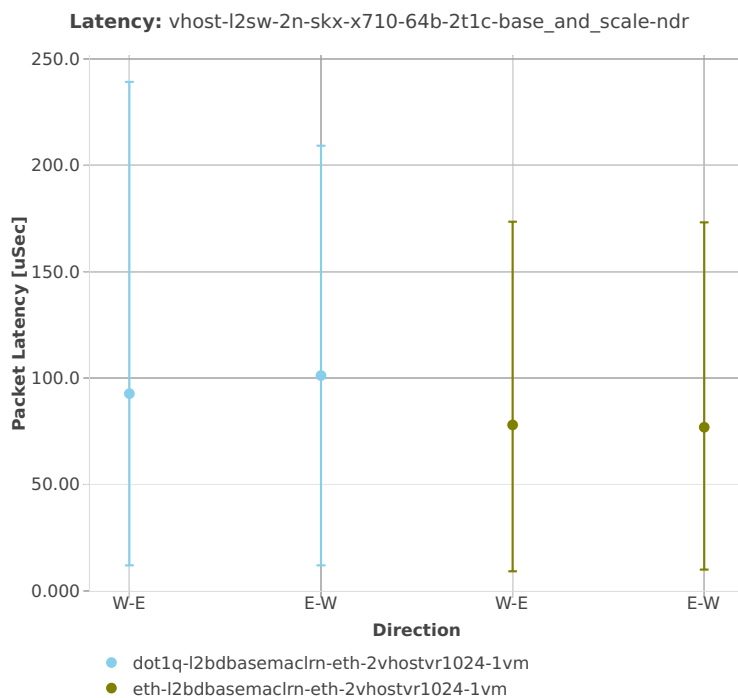

64b-4t2c-base\_and\_scale-l2sw

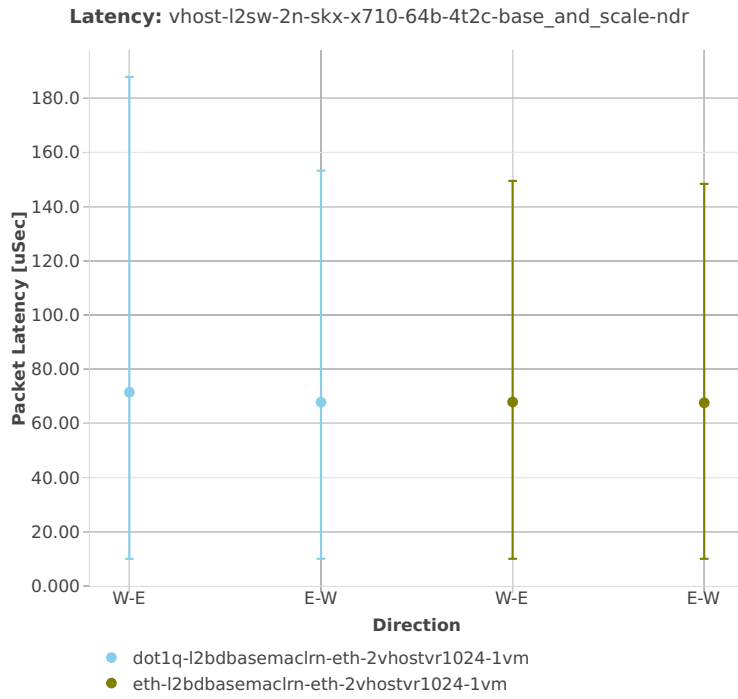

64b-2t1c-base-vm-l2sw

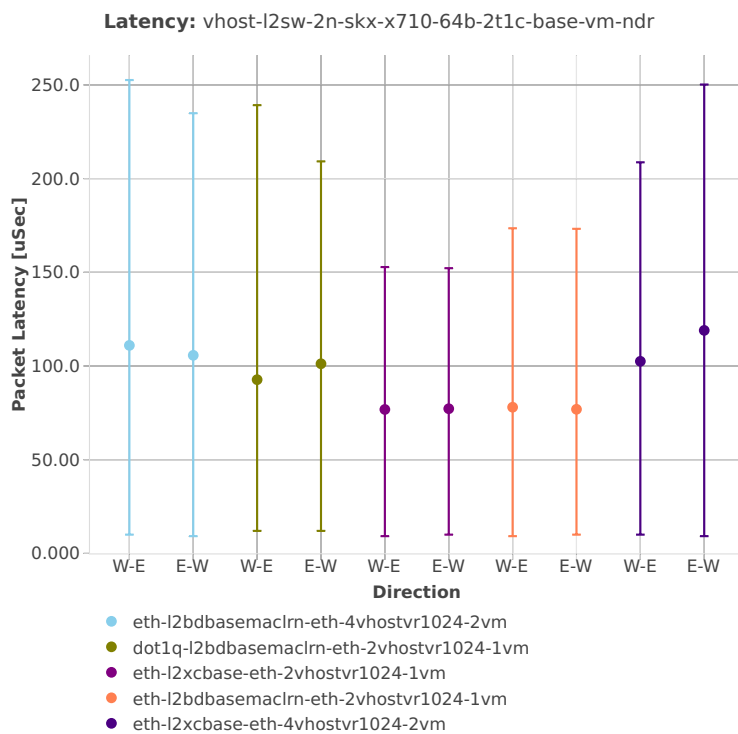

64b-4t2c-base-vm-l2sw

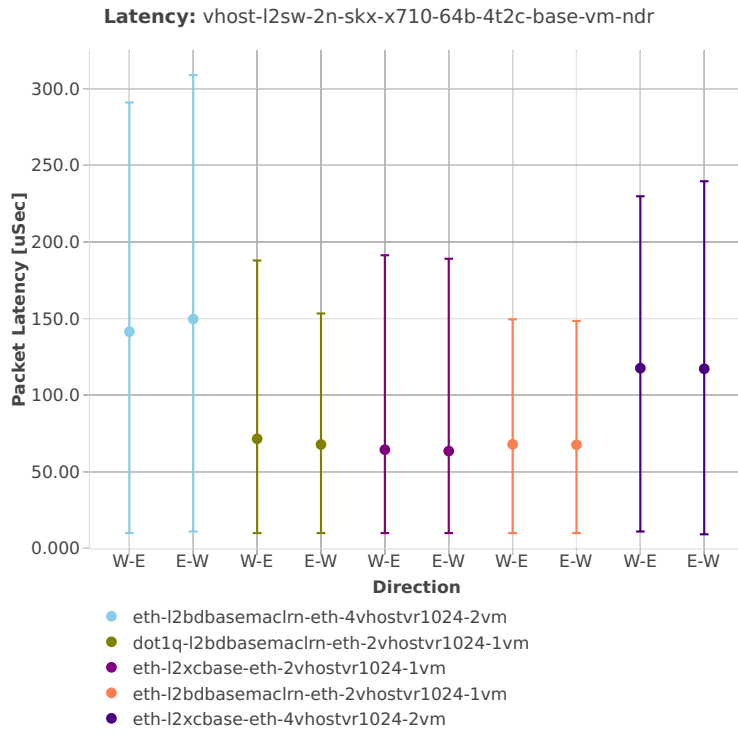

64b-2t1c-base\_and\_scale-ip4

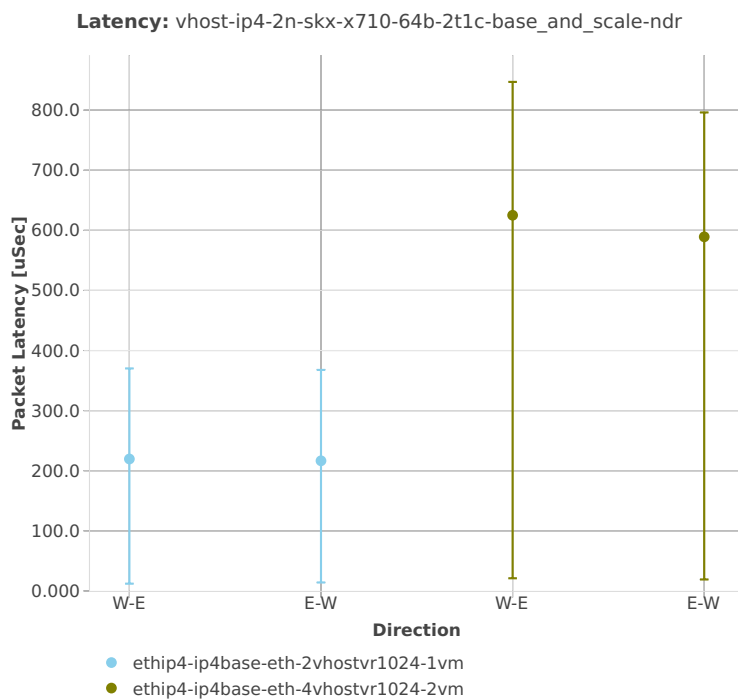

64b-4t2c-base\_and\_scale-ip4

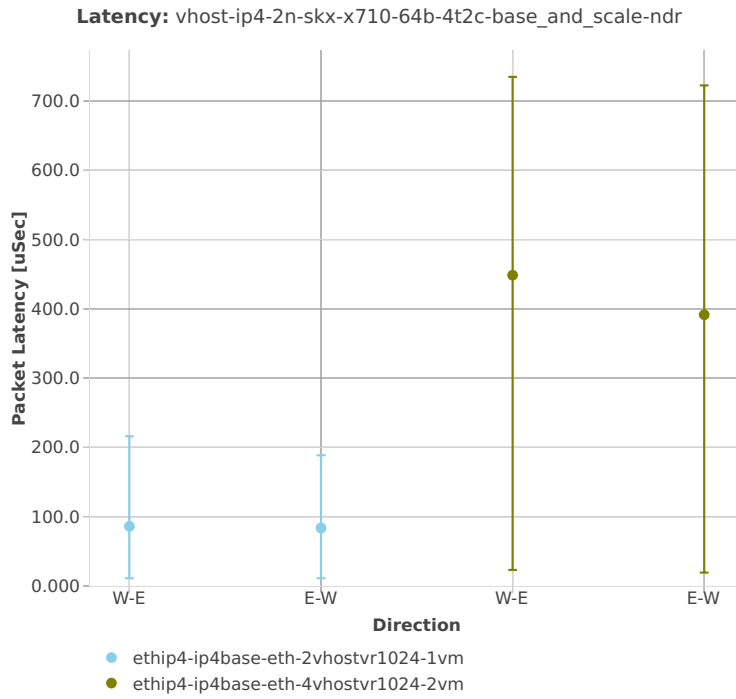



2n-skx-xxv710

64b-2t1c-base-l2sw

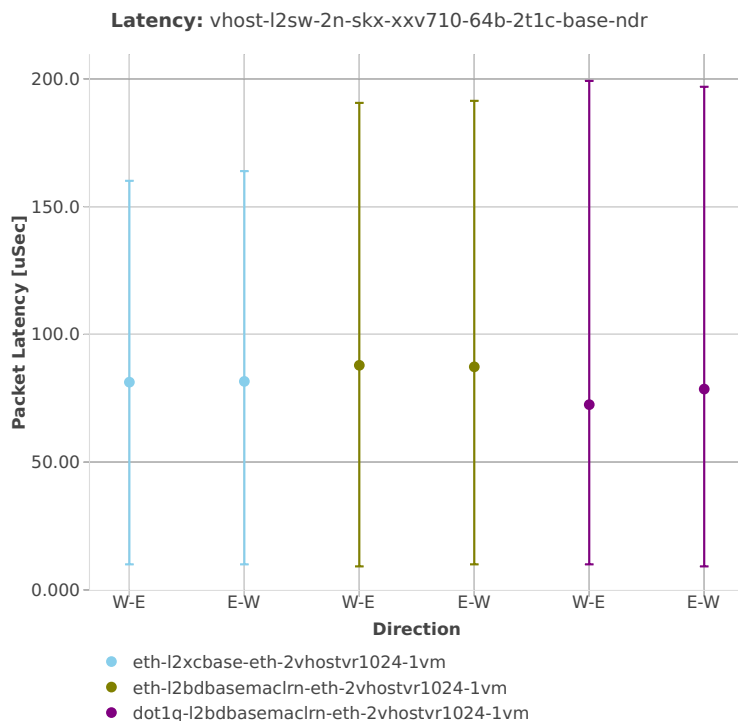

64b-4t2c-base-l2sw

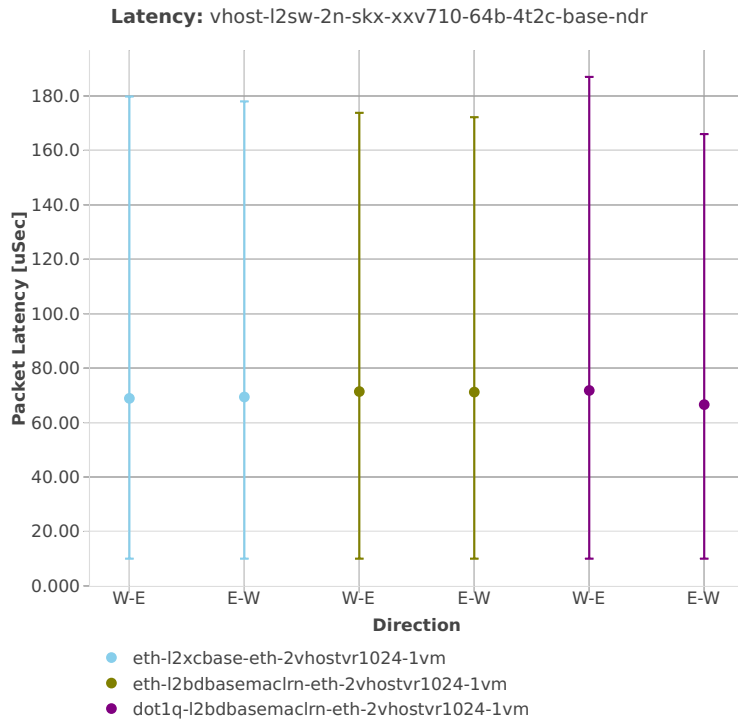

64b-2t1c-base\_and\_scale-l2sw

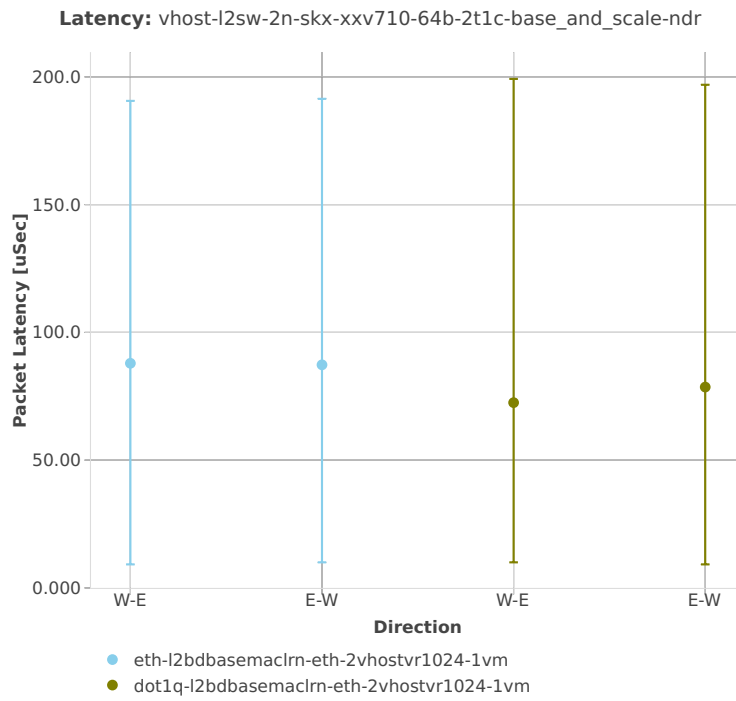

64b-4t2c-base\_and\_scale-l2sw

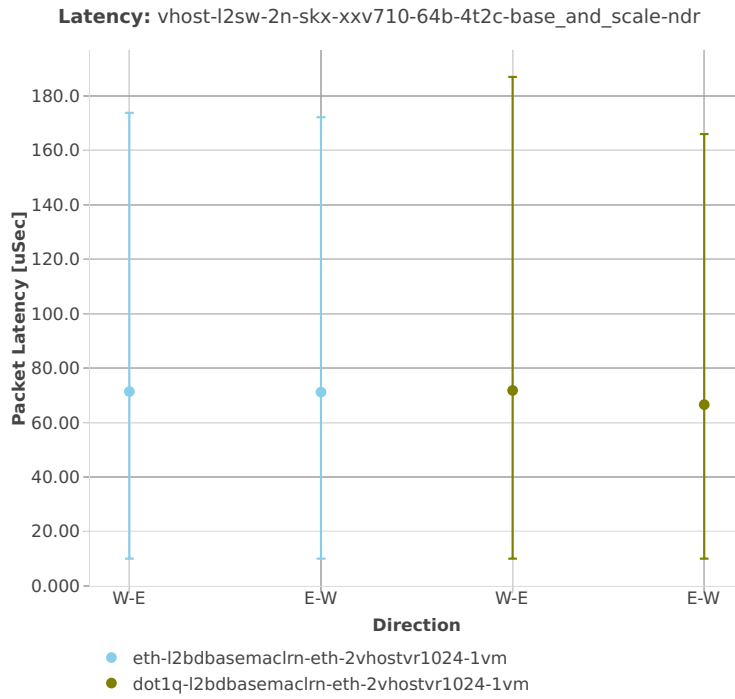

64b-2t1c-base-vm-l2sw

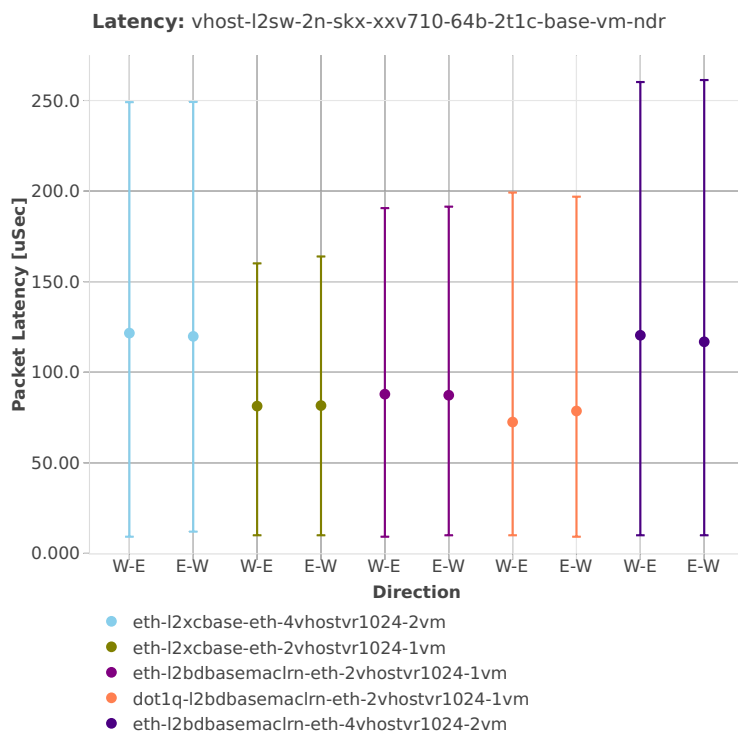

64b-4t2c-base-vm-l2sw

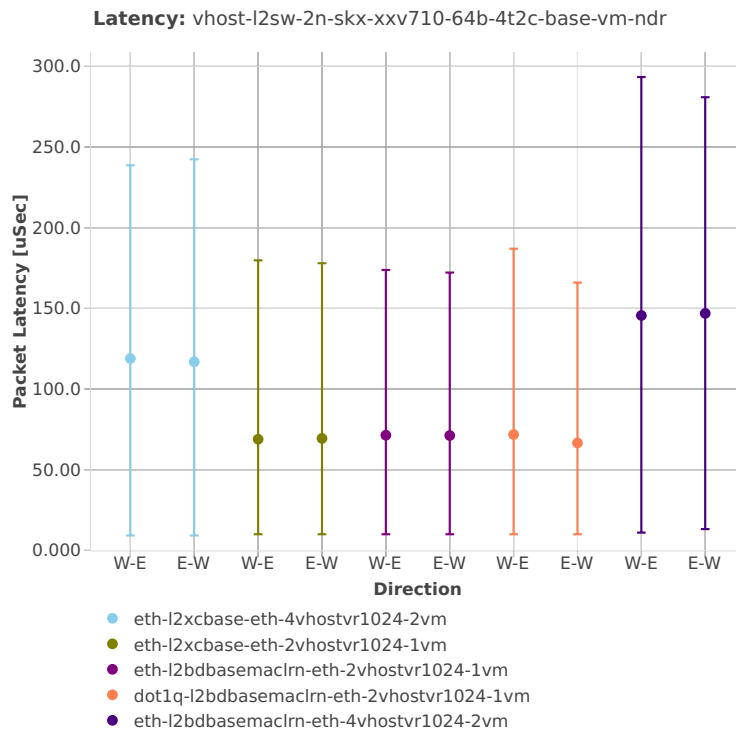

64b-2t1c-base\_and\_scale-ip4

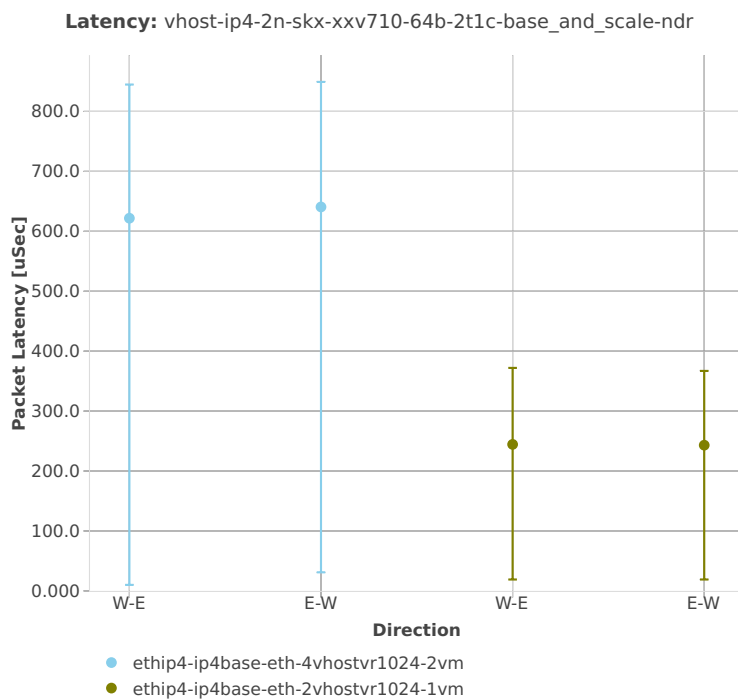

64b-4t2c-base\_and\_scale-ip4

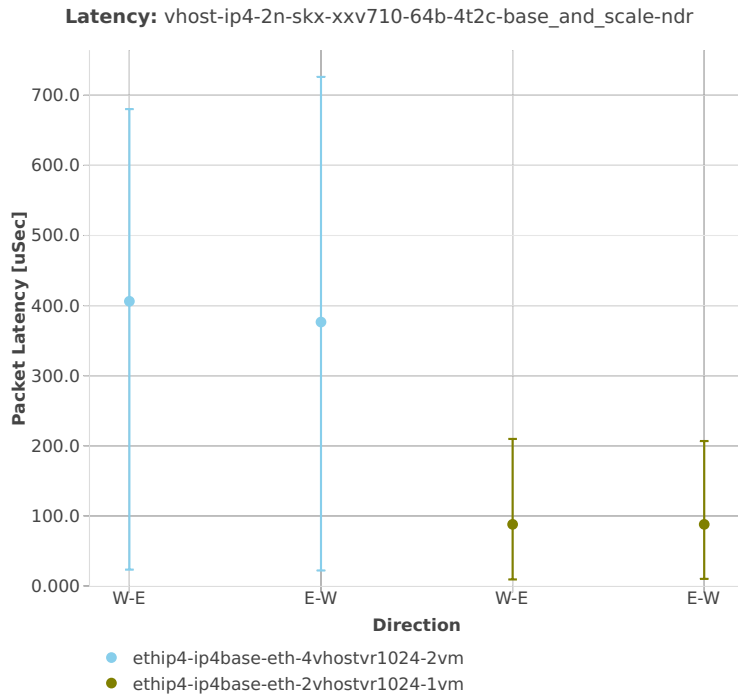



## 2.5.8 LXC/DRC Container Memif

This section includes summary graphs of VPP Phy-to-Phy packet latency with Container memif Connections measured at 100% of discovered NDR throughput rate. Latency is reported for VPP running in multiple configurations of VPP worker thread(s), a.k.a. VPP data plane thread(s), and their physical CPU core(s) placement.

CSIT source code for the test cases used for plots can be found in [CSIT git repository](#)<sup>75</sup>.

---

<sup>75</sup> [https://git.fd.io/csit/tree/tests/vpp/perf/container\\_memif?h=rls1901](https://git.fd.io/csit/tree/tests/vpp/perf/container_memif?h=rls1901)

3n-hsw-x520

64b-1t1c-base\_and\_scale

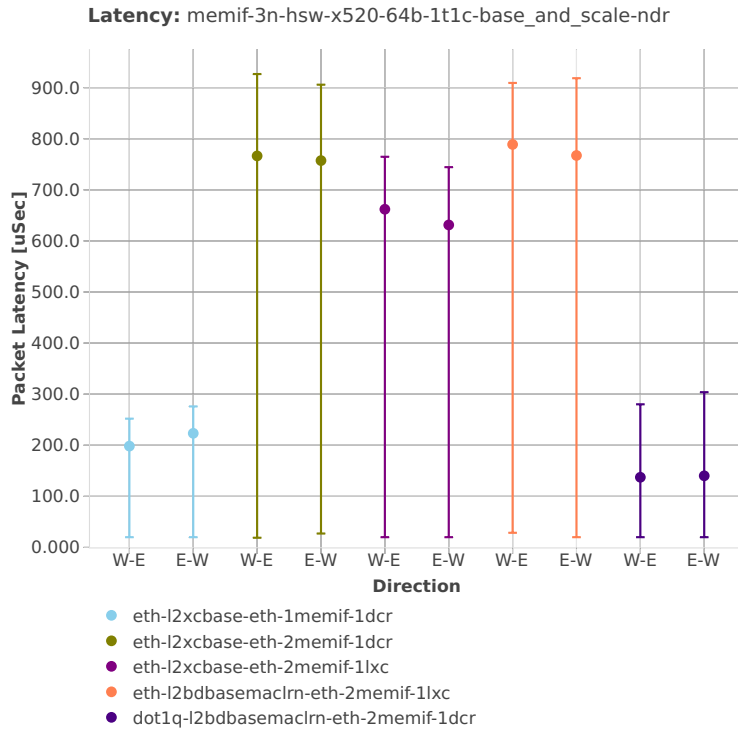

64b-2t2c-base\_and\_scale

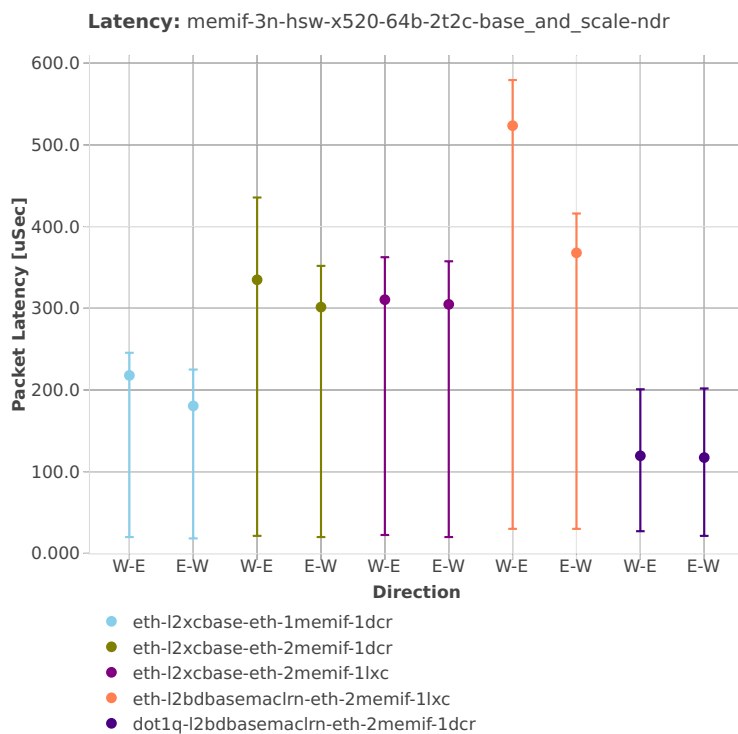

3n-hsw-x710

64b-1t1c-base\_and\_scale

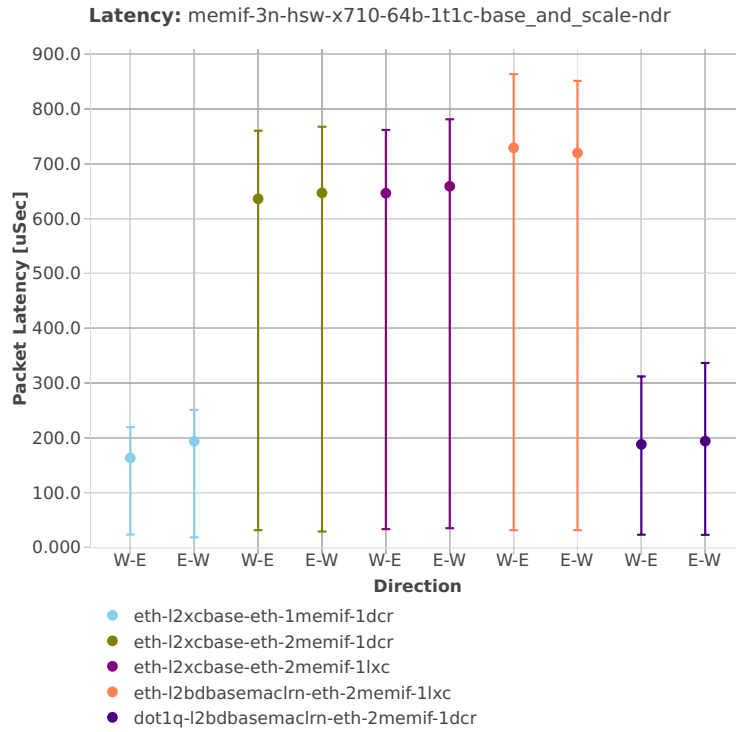

64b-2t2c-base\_and\_scale

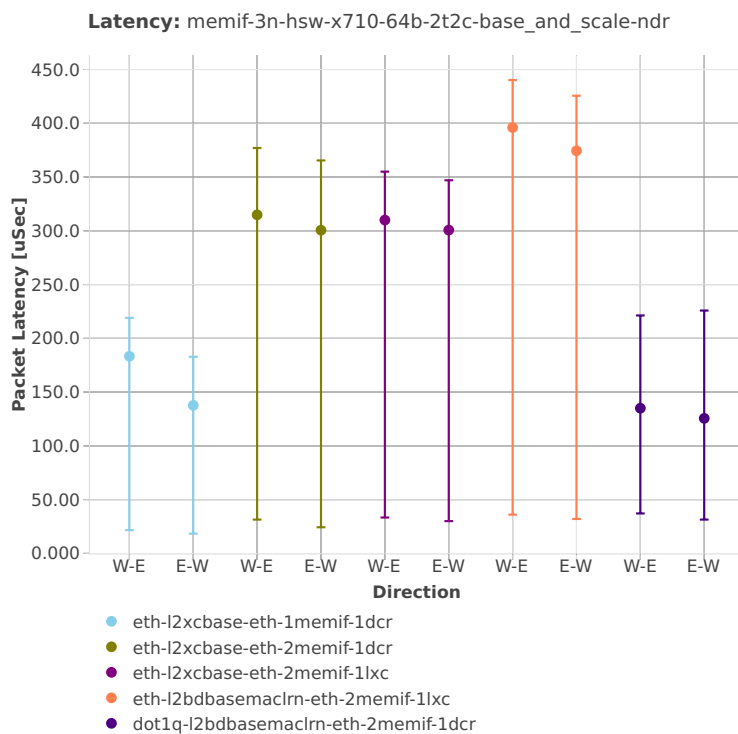

3n-hsw-xl710

64b-1t1c-base\_and\_scale

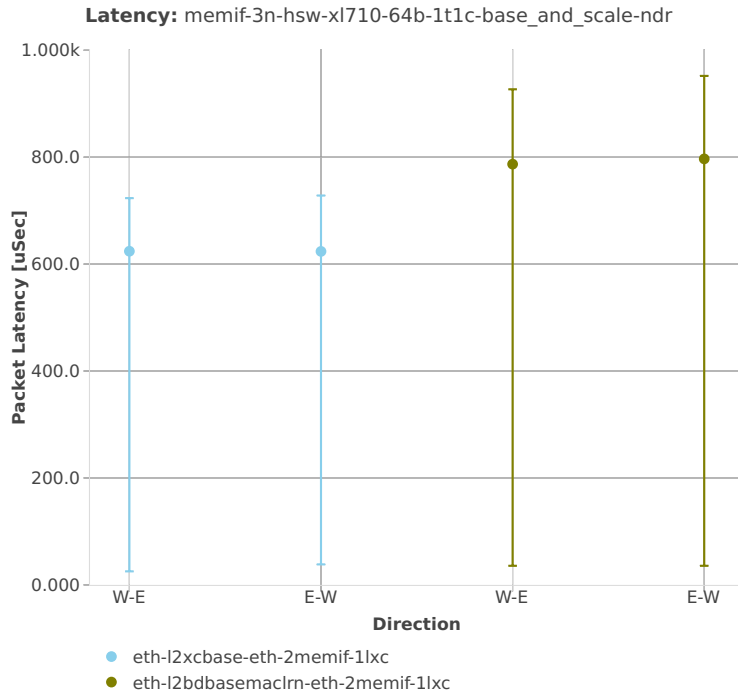

64b-2t2c-base\_and\_scale

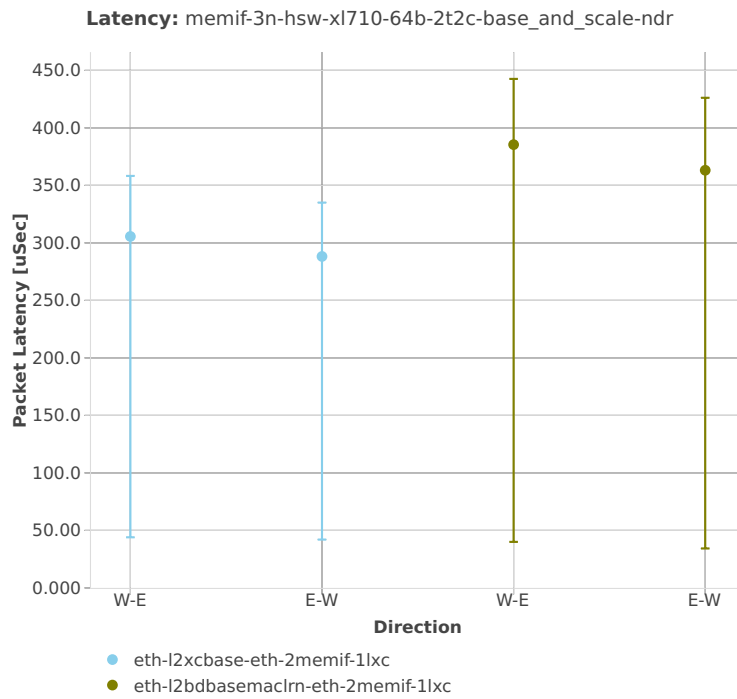

3n-skx-x710

64b-2t1c-base\_and\_scale

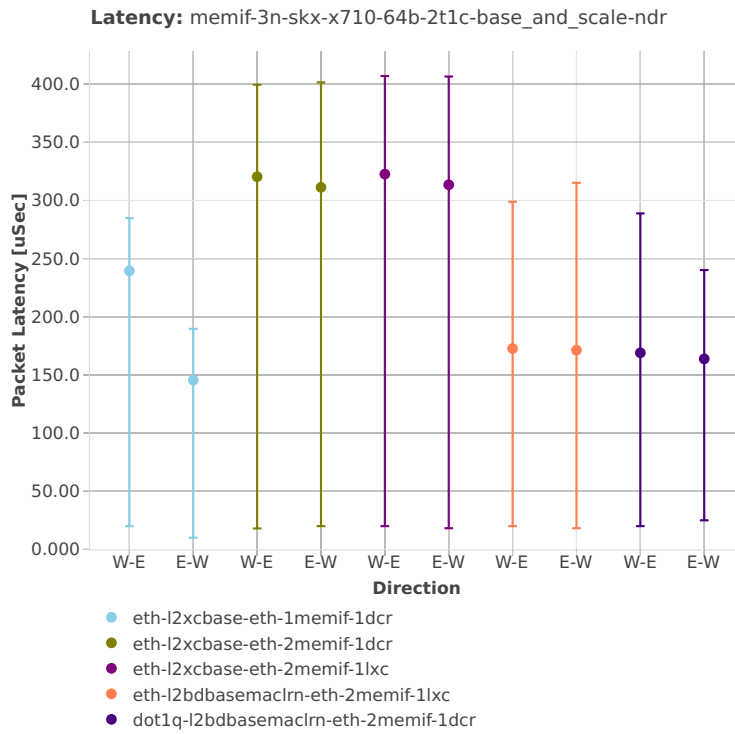



64b-4t2c-base\_and\_scale

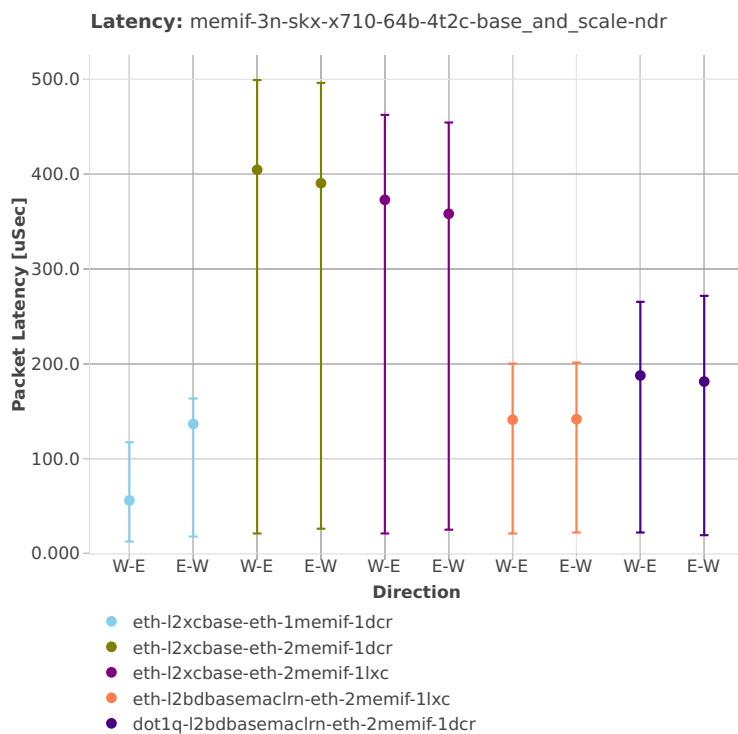

2n-skx-x710

64b-2t1c-base\_and\_scale

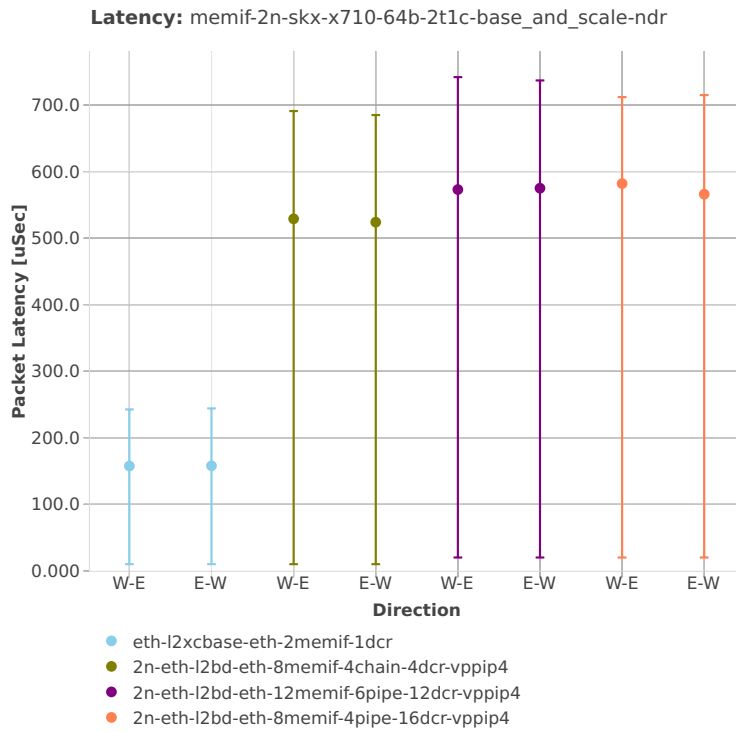

64b-4t2c-base\_and\_scale

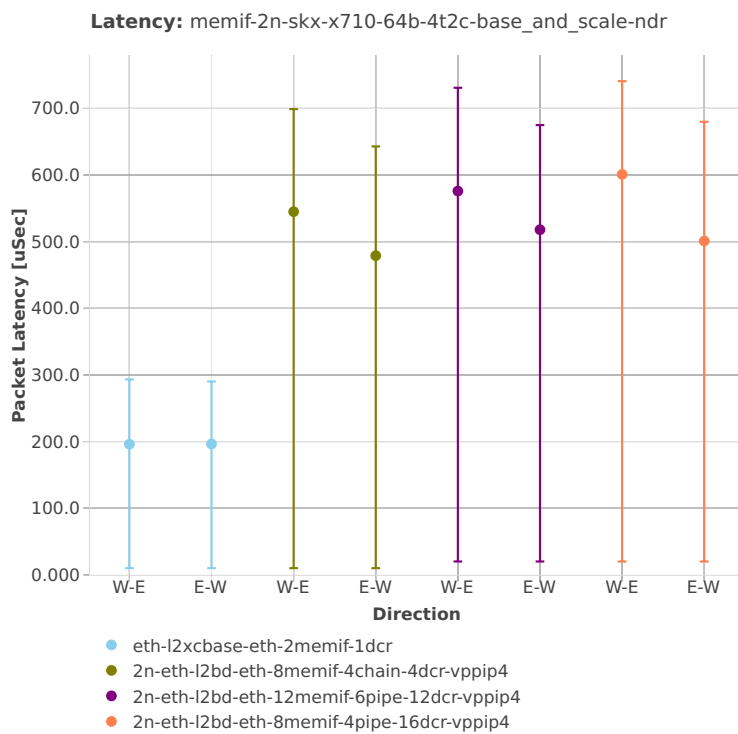

2n-skx-xxv710

64b-2t1c-base\_and\_scale

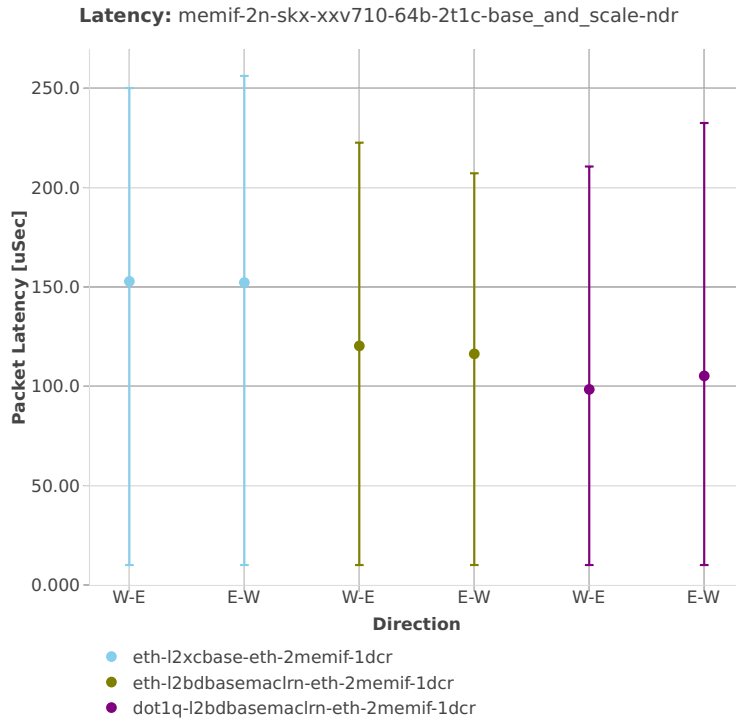

64b-4t2c-base\_and\_scale

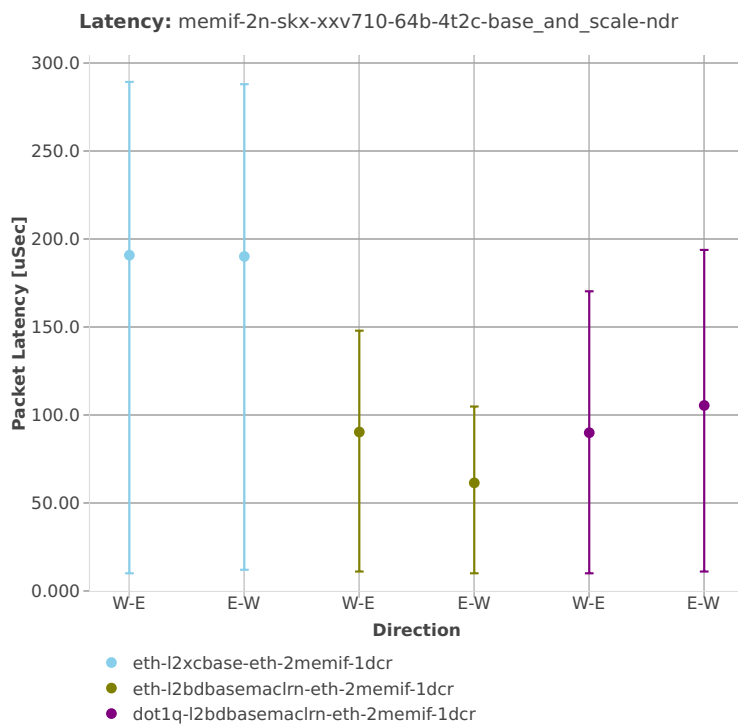

### 2.5.9 IPsec IPv4 Routing

This section includes summary graphs of VPP Phy-to-Phy packet latency with IPsec encryption used in combination with IPv4 routed-forwarding, with latency measured at 100% of discovered NDR throughput rate. VPP IPsec encryption is accelerated using DPDK cryptodev library driving Intel Quick Assist (QAT) crypto PCIe hardware cards. Latency is reported for VPP running in multiple configurations of VPP worker thread(s), a.k.a. VPP data plane thread(s), and their physical CPU core(s) placement.

CSIT source code for the test cases used for plots can be found in [CSIT git repository](#)<sup>76</sup>.

---

<sup>76</sup> <https://git.fd.io/csit/tree/tests/vpp/perf/crypto?h=rls1901>

3n-hsw-xl710

64b-1t1c-base

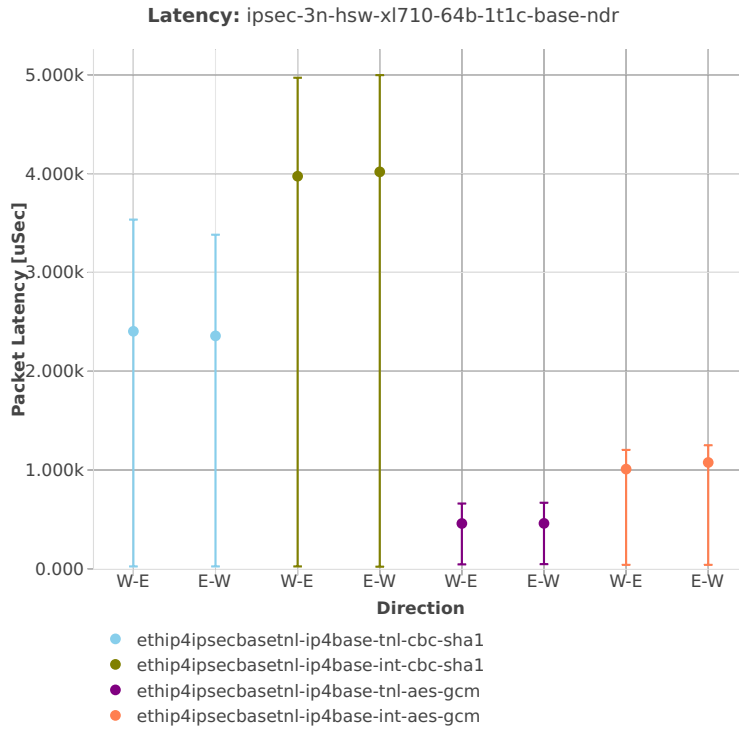

64b-2t2c-base

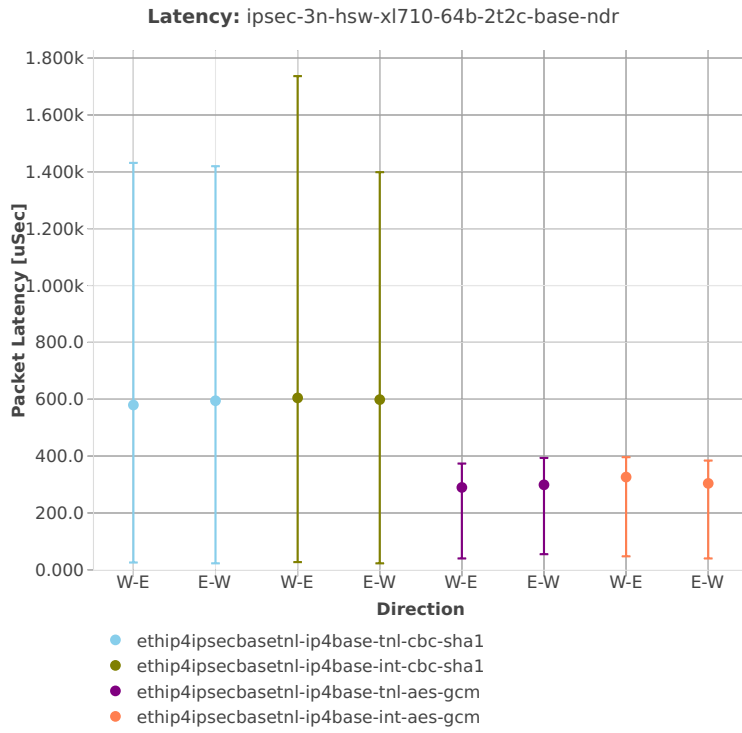



64b-1t1c-scale

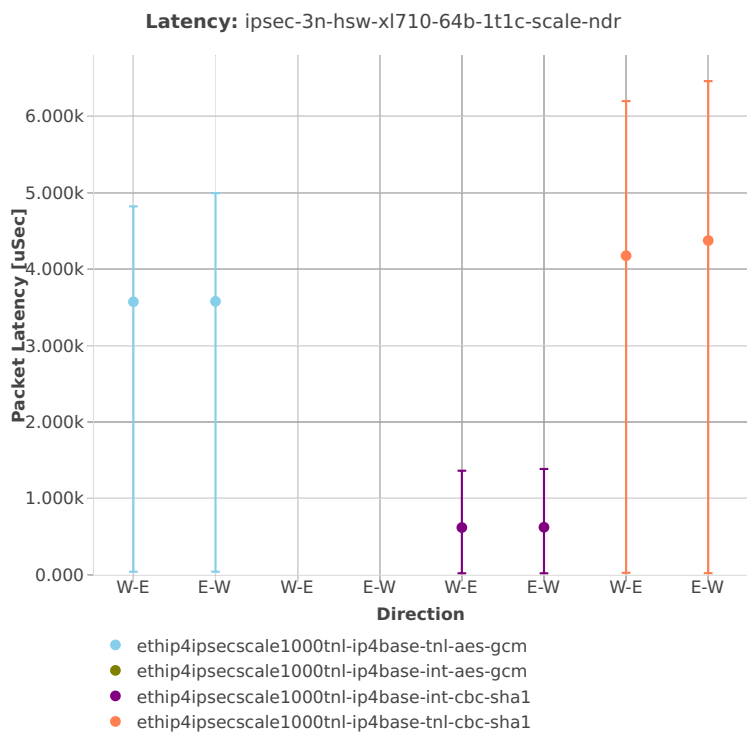

64b-2t2c-scale

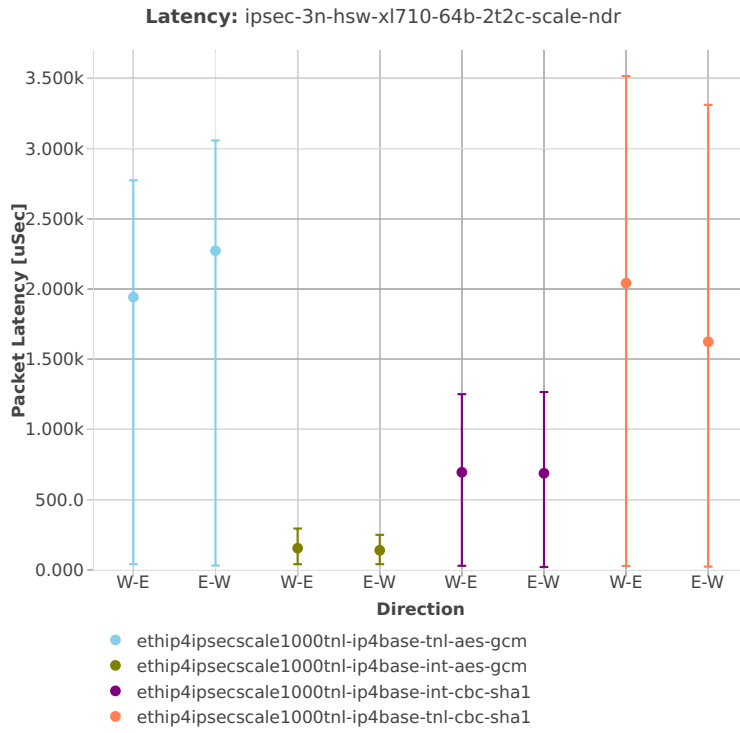

64b-1t1c-sw

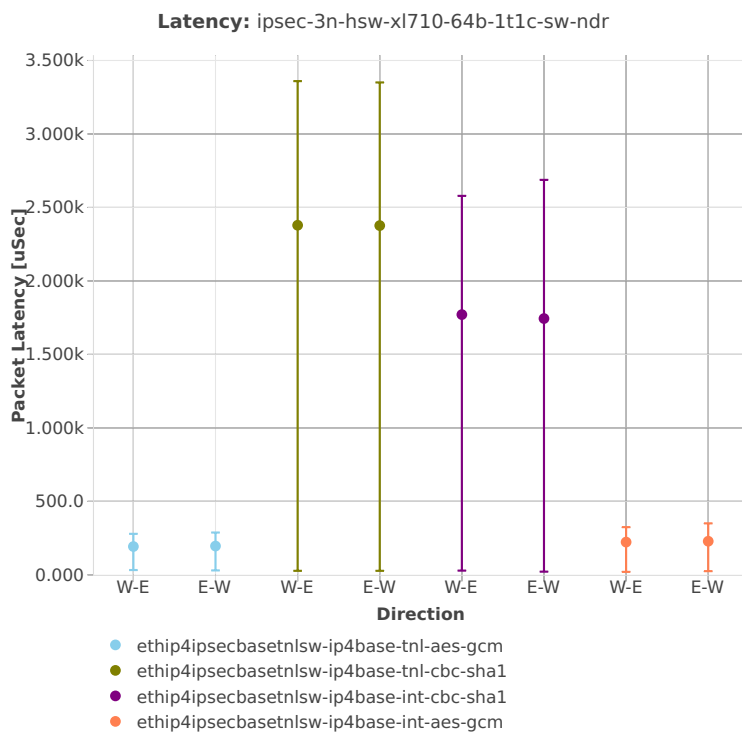

64b-2t2c-sw

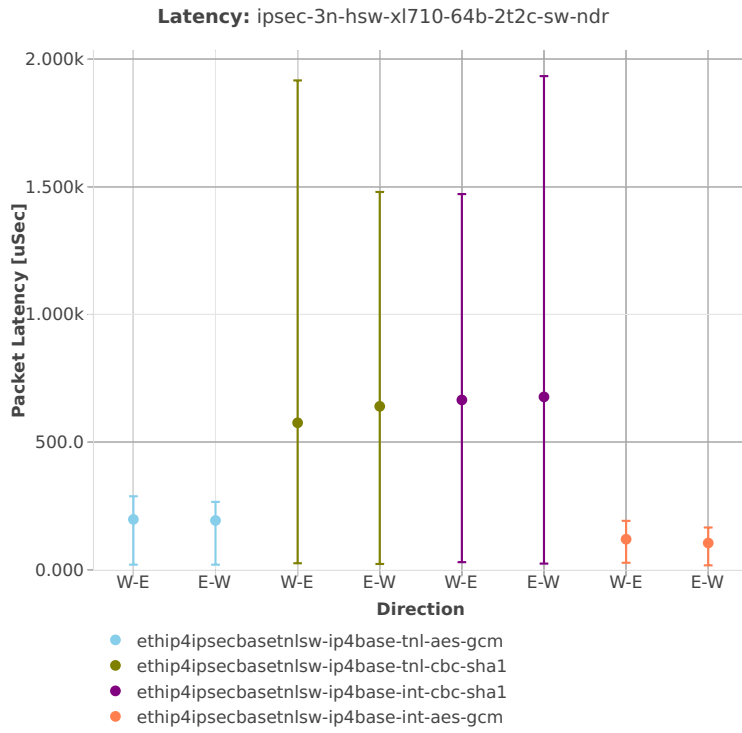

## 2.6 Soak Tests

Long duration soak tests are executed using PLRsearch algorithm. See methodology section for PLRsearch description.

Additional information about graph data:

1. **Graph Title:** describes type of tests and soak test duration.
2. **X-axis Labels:** indices of test suites.
3. **Y-axis Labels:** measured packet throughput values in [Mpps].
4. **Graph Legend:** list of X-axis indices with CSIT test suites.
5. **Hover Information:** lists the lower and upper bounds of measured throughput.

---

**Note:** Test results have been generated by [FD.io test executor vpp performance job 2n-skx<sup>77</sup>](#) with RF result files csit-vpp-perf-1901-\*.zip [archived here](#).

---

---

<sup>77</sup> <https://jenkins.fd.io/view/csit/job/csit-vpp-perf-verify-1901-2n-skx>

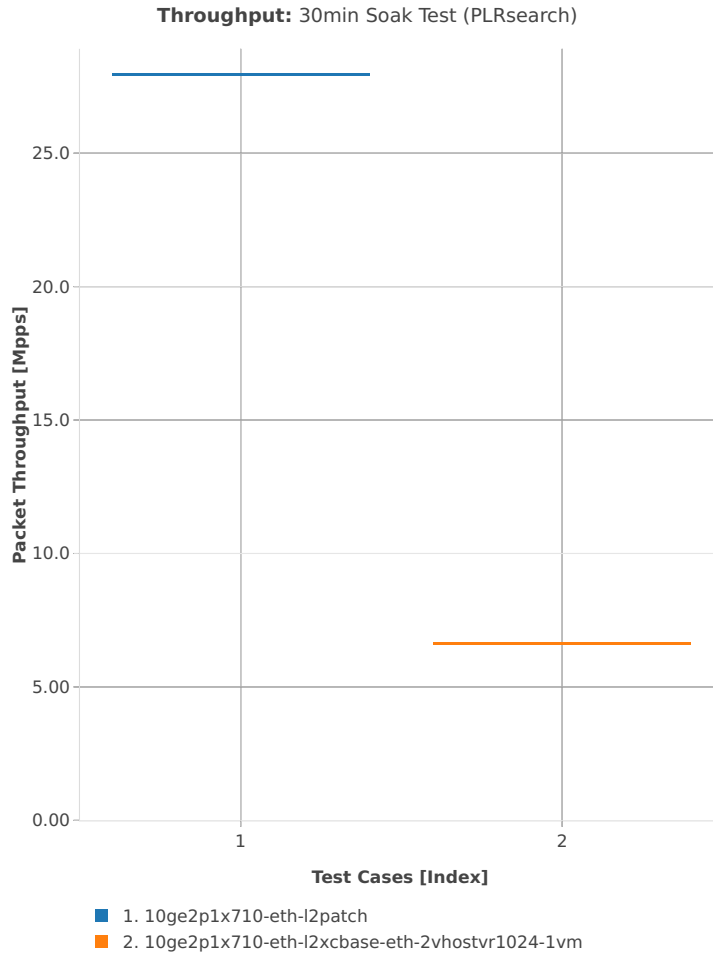

## 2.7 NFV Service Density

NFV Service Density is benchmarked in three distinct NF service configurations:

- VNF Service Chains
- CNF Service Chains
- CNF Service Pipelines

Each configuration is tested in a number of service density combinations [Number of Service Instances] x [Number of NFs per Service Instance]. The actual tested range is based on available CPU physical core resources.

### 2.7.1 VNF Service Chains

Throughput graphs for VNF service chains are generated by multiple executions of tests covering a range of VNF service densities defined as [Number of Service Chains] x [Number of VNFs per Service Chain]. The results are presented in the service density graph.

Additional information about graph data:

1. **Graph Title:** describes tested packet path including VNF workload running in each VM.
2. **X-axis Labels:** VNFs per service chain.
3. **Y-axis Labels:** number of service chains.
4. **Z-axis Color Scale:** lists 64B Packet Throughput (mean MRR/NDR/PDR value) in Mpps.
5. **Hover Information:** specific test substring listing vhost-chain-vm combinations, number of runs executed, mean MRR/NDR/PDR throughput in Mpps, standard deviation.

---

**Note:** Test results have been generated by [FD.io test executor vpp performance job 2n-skx](#)<sup>78</sup> with RF result files csit-vpp-perf-1901-\*.zip [archived here](#).

---

---

<sup>78</sup> <https://jenkins.fd.io/view/csit/job/csit-vpp-perf-verify-1901-2n-skx>



2n-skx-x710-mrr

64b-2t1c-eth-l2bd

**Throughput:** eth-l2bd-{2XY}vhost-{Y}chain-{XY}vm-l3fdip4-mrr

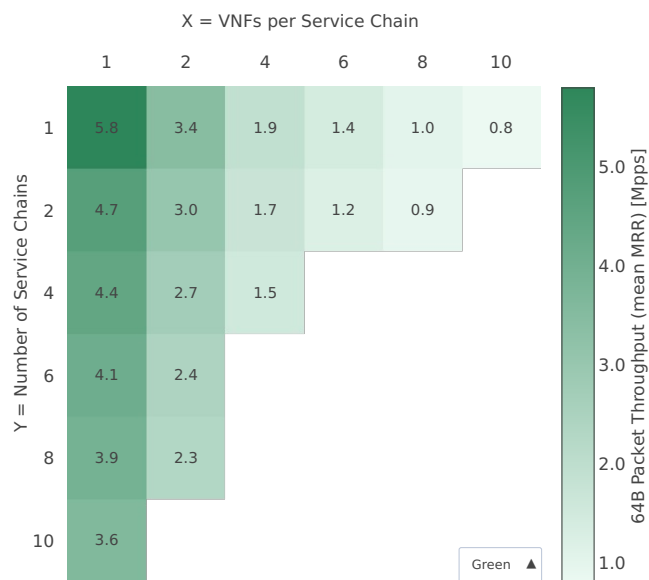

64b-4t2c-eth-l2bd

**Throughput:** eth-l2bd-{2XY}vhost-{Y}chain-{XY}vm-l3fdip4-mrr

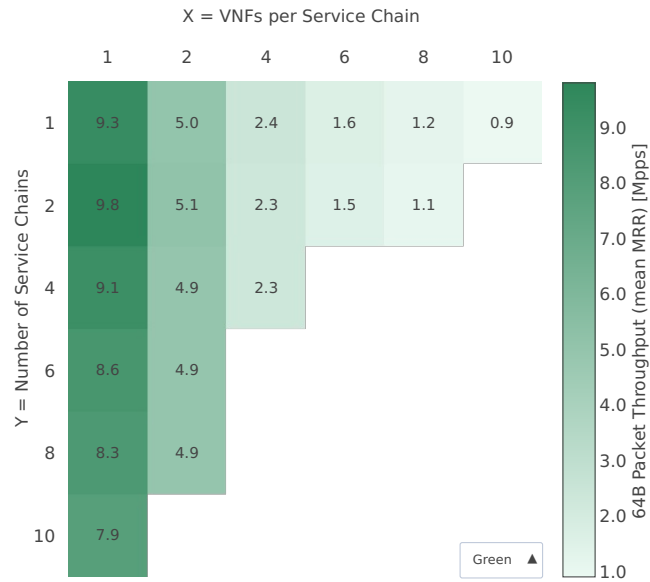

imix-2t1c-eth-l2bd

**Throughput:** eth-l2bd-{2XY}vhost-{Y}chain-{XY}vm-l3fdip4-mrr

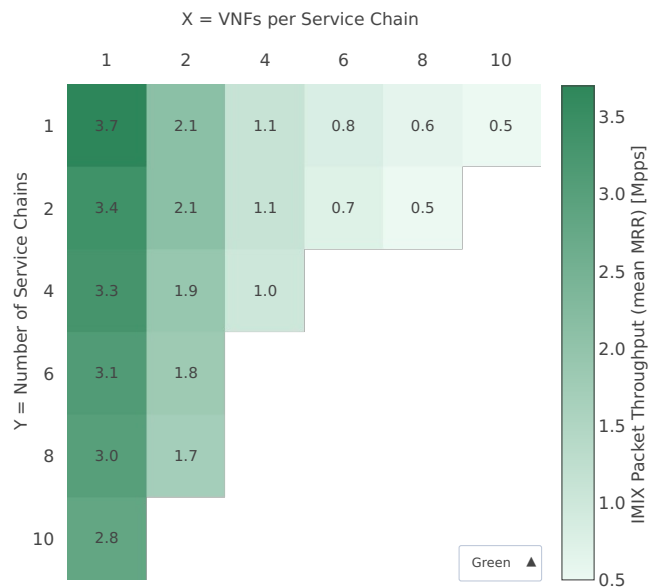

imix-4t2c-eth-l2bd

**Throughput:** eth-l2bd-{2XY}vhost-{Y}chain-{XY}vm-l3fdip4-mrr

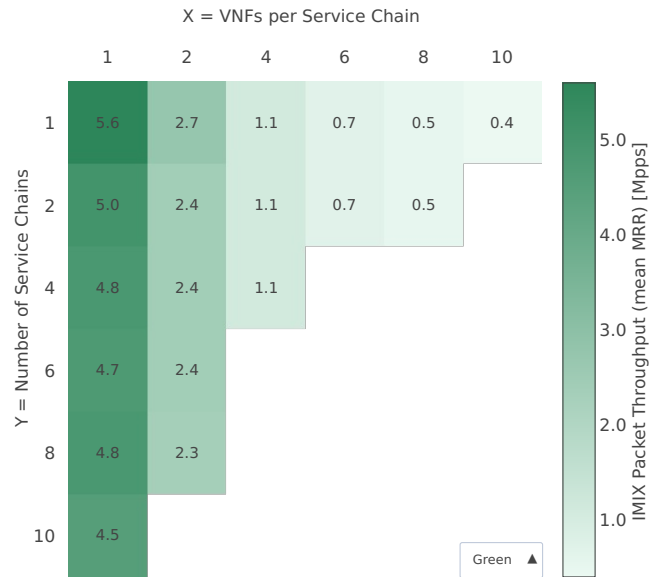

2n-skx-x710-ndr

64b-2t1c-eth-l2bd

**Throughput:** eth-l2bd-{2XY}vhost-{Y}chain-{XY}vm-l3fwdip4-ndr

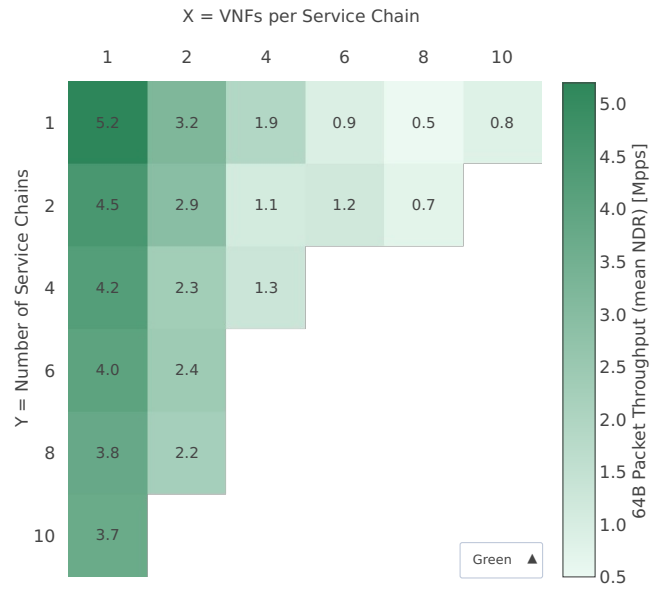

64b-4t2c-eth-l2bd

**Throughput:** eth-l2bd-{2XY}vhost-{Y}chain-{XY}vm-l3fdip4-ndr

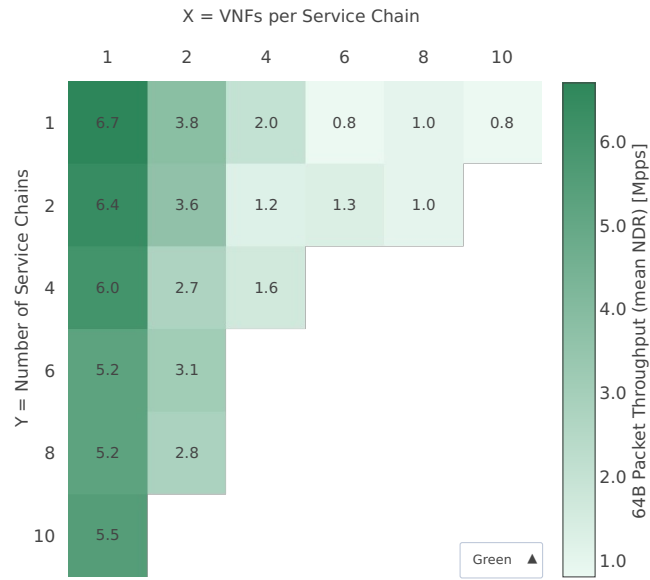

imix-2t1c-eth-l2bd

**Throughput:** eth-l2bd-{2XY}vhost-{Y}chain-{XY}vm-l3fdip4-ndr

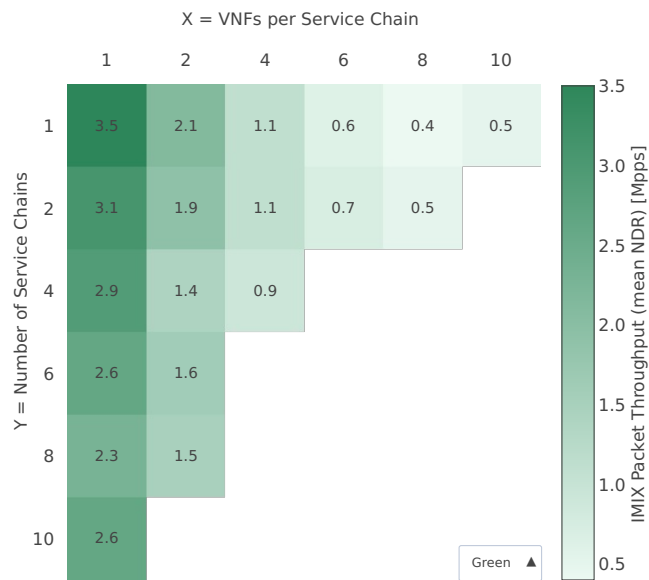

imix-4t2c-eth-l2bd

**Throughput:** eth-l2bd-{2XY}vhost-{Y}chain-{XY}vm-l3fdip4-ndr

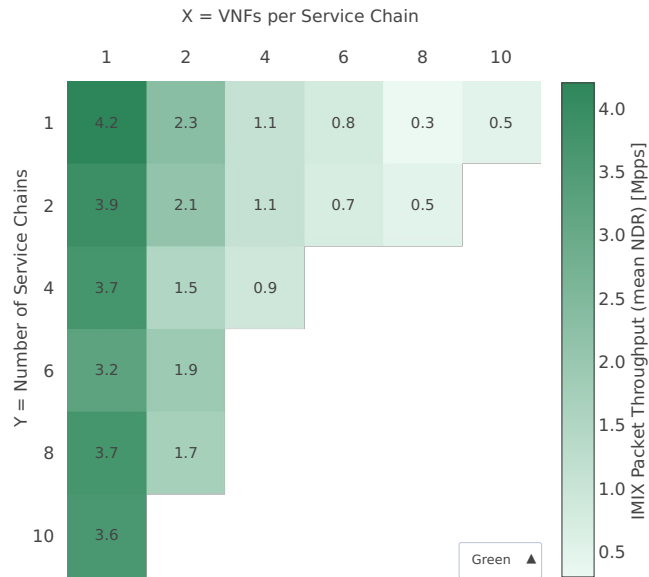



2n-skx-x710-pdr

64b-2t1c-eth-l2bd

**Throughput:** eth-l2bd-{2XY}vhost-{Y}chain-{XY}vm-l3fwdip4-pdr

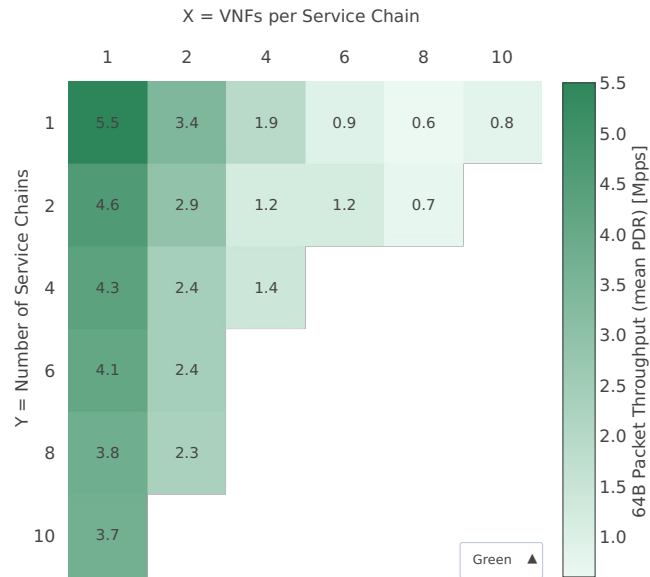

64b-4t2c-eth-l2bd

**Throughput:** eth-l2bd-{2XY}vhost-{Y}chain-{XY}vm-l3fdip4-pdr

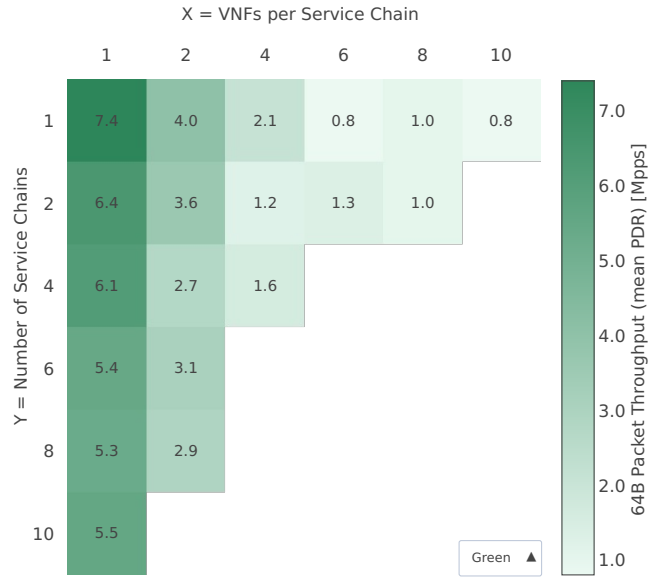

imix-2t1c-eth-l2bd

**Throughput:** eth-l2bd-{2XY}vhost-{Y}chain-{XY}vm-l3fdip4-pdr

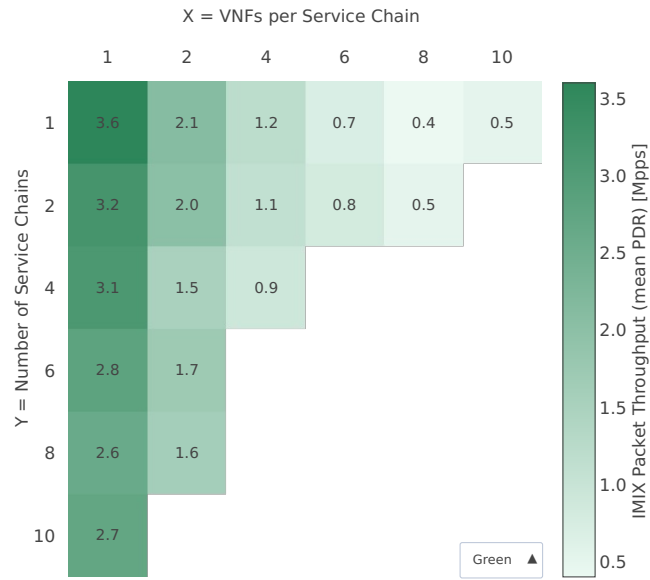

imix-4t2c-eth-l2bd

**Throughput:** eth-l2bd-{2XY}vhost-{Y}chain-{XY}vm-l3fdip4-pdr

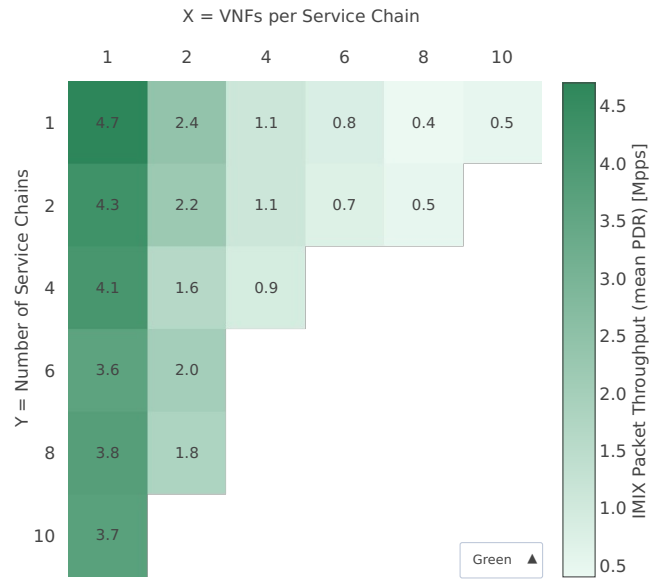

## 2.7.2 CNF Service Chains

Throughput graphs for CNF service chains are generated by multiple executions of tests covering a range of CNF service densities defined as [Number of Service Chains] x [Number of CNFs per Service Chain]. The results are presented in the service density graph.

Additional information about graph data:

1. **Graph Title:** describes tested packet path including CNF workload running in each Docker Container.
2. **X-axis Labels:** CNFs per service chain.
3. **Y-axis Labels:** number of service chains.
4. **Z-axis Color Scale:** lists 64B Packet Throughput (mean MRR/NDR/PDR value) in Mpps.
5. **Hover Information:** specific test substring listing memif-chain-docker\_container combinations, number of runs executed, mean MRR/NDR/PDR throughput in Mpps, standard deviation.

---

**Note:** Test results have been generated by [FD.io test executor vpp performance job 2n-skx](#)<sup>79</sup> with RF result files csit-vpp-perf-1901-\*.zip [archived here](#).

---

---

<sup>79</sup> <https://jenkins.fd.io/view/csit/job/csit-vpp-perf-verify-1901-2n-skx>

2n-skx-x710-mrr

64b-2t1c-eth-l2bd

**Throughput:** eth-l2bd-{2XY}memif-{Y}chain-{XY}drc-vppip4-mrr

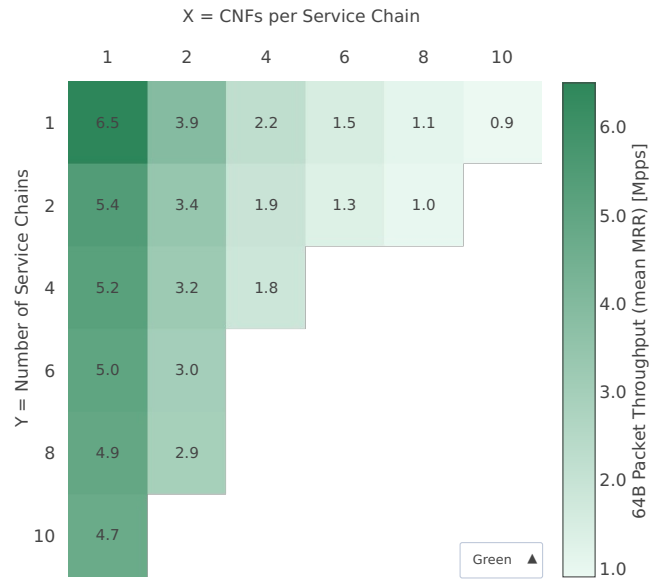

64b-4t2c-eth-l2bd

**Throughput:** eth-l2bd-{2XY}memif-{Y}chain-{XY}drc-vppip4-mrr

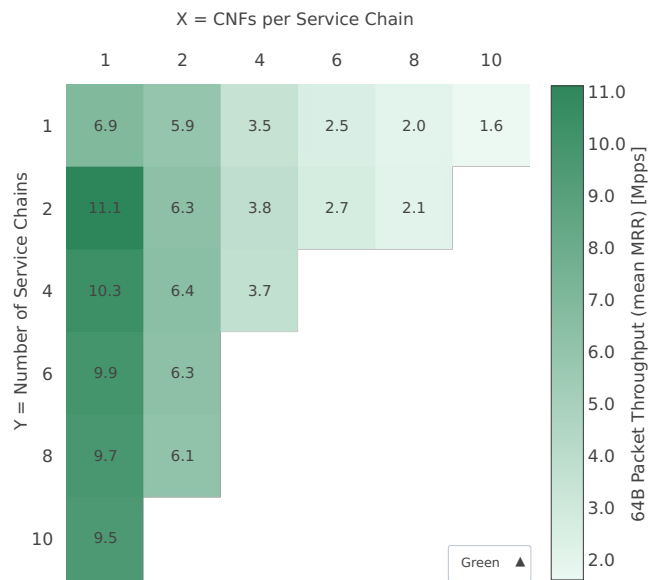

imix-2t1c-eth-l2bd

**Throughput:** eth-l2bd-{2XY}memif-{Y}chain-{XY}drc-vppip4-mrr

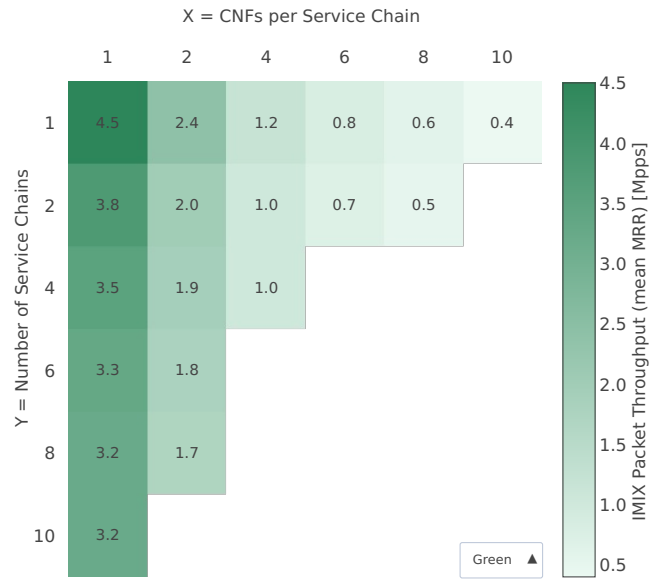



imix-4t2c-eth-l2bd

**Throughput:** eth-l2bd-{2XY}memif-{Y}chain-{XY}drc-vppip4-mrr

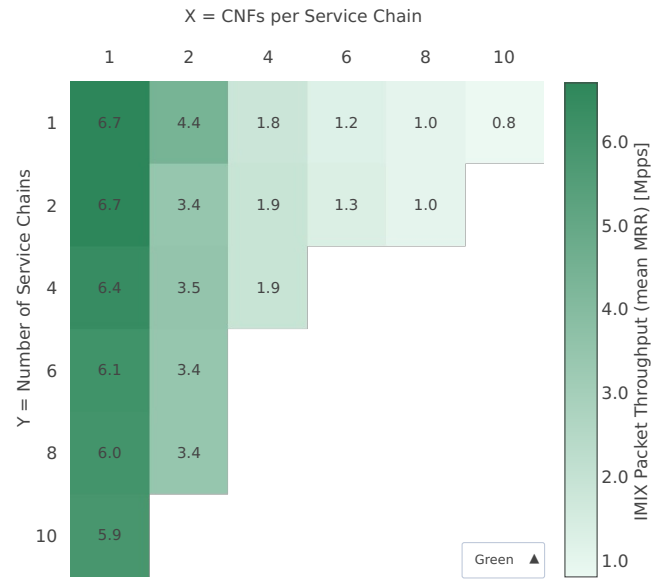

2n-skx-x710-ndr

64b-2t1c-eth-l2bd

**Throughput:** eth-l2bd-{2XY}memif-{Y}chain-{XY}drc-vppip4-ndr

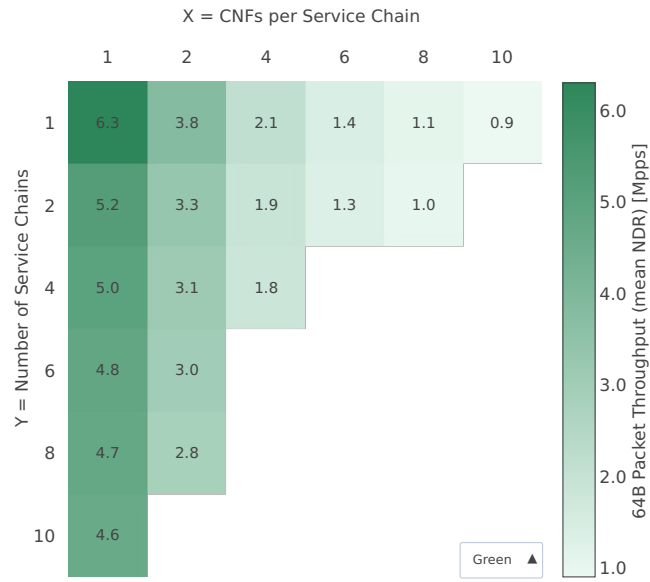

64b-4t2c-eth-l2bd

Throughput: eth-l2bd-{2XY}memif-{Y}chain-{XY}drc-vppip4-ndr

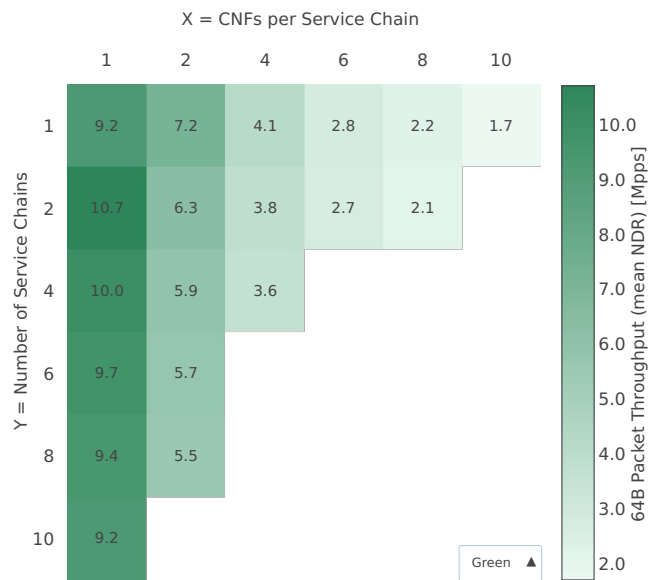

imix-2t1c-eth-l2bd

**Throughput:** eth-l2bd-{2XY}memif-{Y}chain-{XY}drc-vppip4-ndr

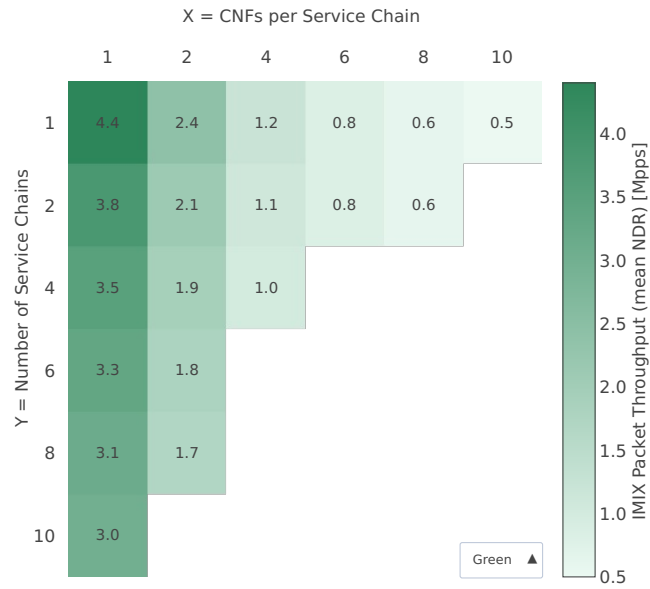

imix-4t2c-eth-l2bd

Throughput: eth-l2bd-{2XY}memif-{Y}chain-{XY}drc-vppip4-ndr

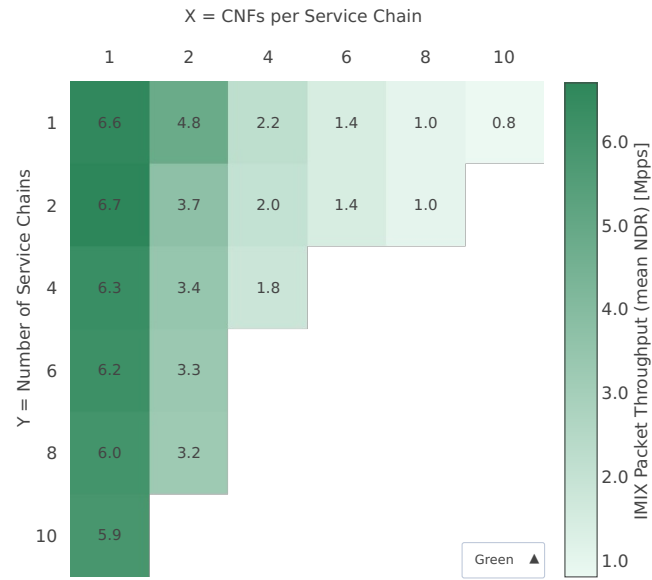

2n-skx-x710-pdr

64b-2t1c-eth-l2bd

**Throughput:** eth-l2bd-{2XY}memif-{Y}chain-{XY}drc-vppip4-pdr

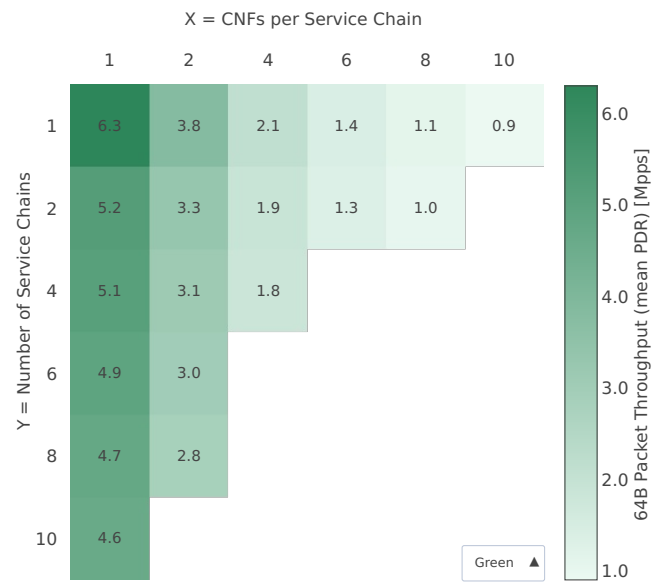

64b-4t2c-eth-l2bd

Throughput: eth-l2bd-{2XY}memif-{Y}chain-{XY}drc-vppip4-pdr

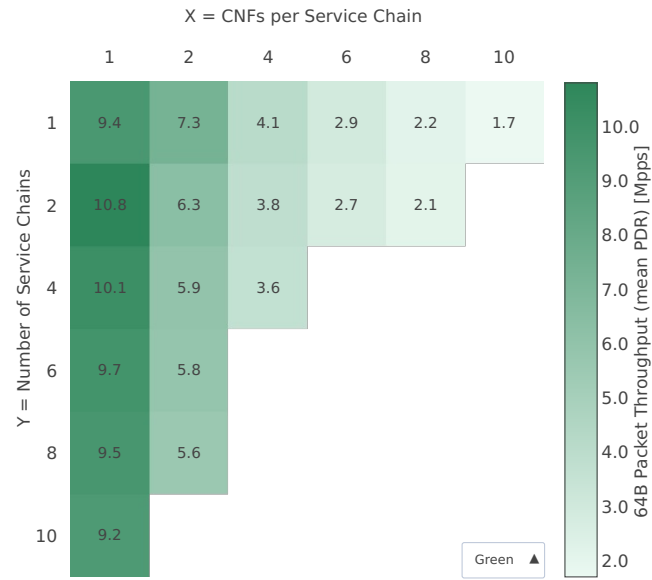

imix-2t1c-eth-l2bd

Throughput: eth-l2bd-{2XY}memif-{Y}chain-{XY}drc-vppip4-pdr

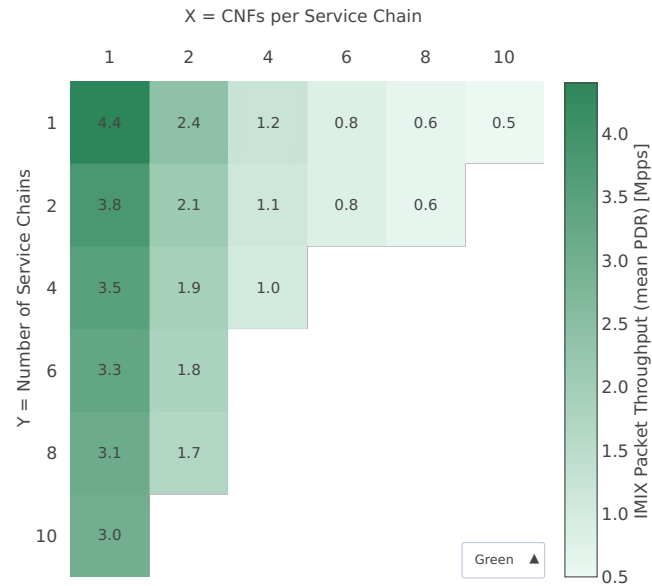



imix-4t2c-eth-l2bd

**Throughput:** eth-l2bd-{2XY}memif-{Y}chain-{XY}drc-vppip4-pdr

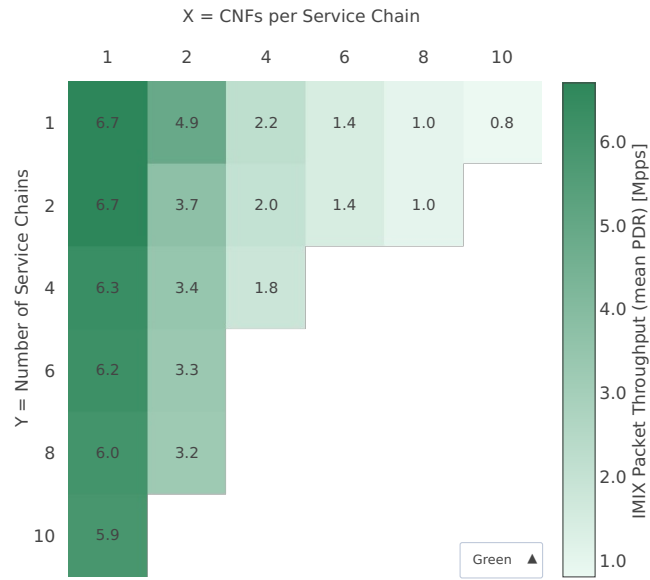

### 2.7.3 CNF Service Pipelines

Throughput graphs for CNF service pipelines are generated by multiple executions of tests covering a range of CNF service densities defined as [Number of Service Pipelines] x [Number of CNFs per Service Pipeline]. The results are presented in the service density graph.

Additional information about graph data:

1. **Graph Title:** describes tested packet path including CNF workload running in each Docker Container.
2. **X-axis Labels:** CNFs per service pipeline.
3. **Y-axis Labels:** number of service pipelines.
4. **Z-axis Color Scale:** lists 64B Packet Throughput (mean MRR/NDR/PDR value) in Mpps.
5. **Hover Information:** specific test substring listing memif-pipeline-docker\_container combinations, number of runs executed, mean MRR/NDR/PDR throughput in Mpps, standard deviation.

---

**Note:** Test results have been generated by [FD.io test executor vpp performance job 2n-skx](#)<sup>80</sup> with RF result files csit-vpp-perf-1901-\*.zip [archived here](#).

---

---

<sup>80</sup> <https://jenkins.fd.io/view/csit/job/csit-vpp-perf-verify-1901-2n-skx>

2n-skx-x710-mrr

64b-2t1c-eth-l2bd

**Throughput:** eth-l2bd-{2Y}memif-{Y}pipe-{XY}drc-vppip4-mrr

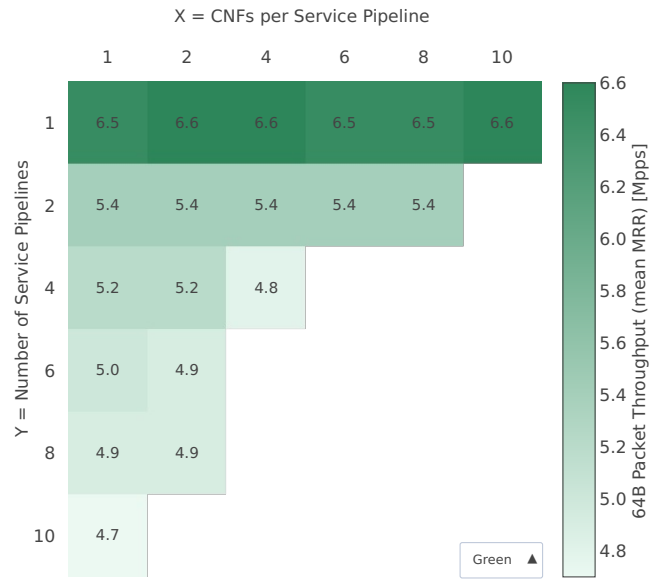

64b-4t2c-eth-l2bd

**Throughput:** eth-l2bd-{2Y}memif-{Y}pipe-{XY}drc-vppip4-mrr

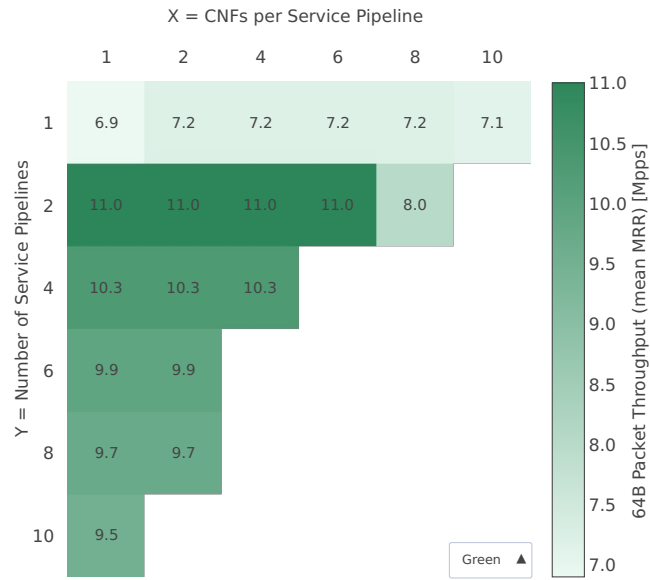

imix-2t1c-eth-l2bd

**Throughput:** eth-l2bd-{2Y}memif-{Y}pipe-{XY}drc-vppip4-mrr

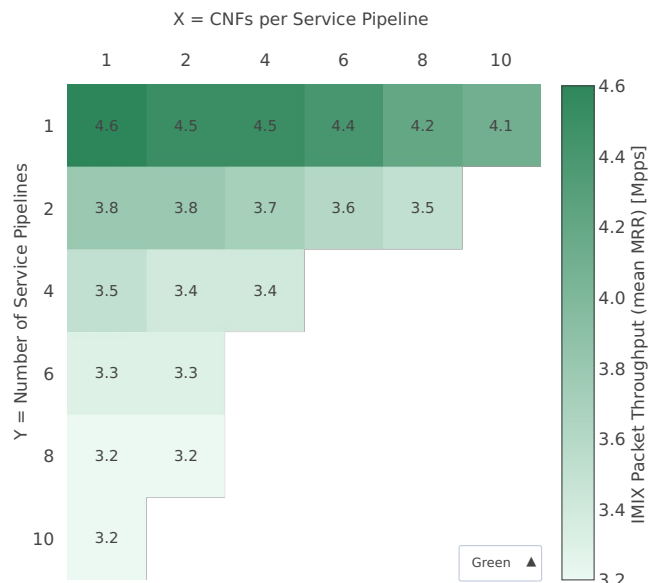

imix-4t2c-eth-l2bd

**Throughput:** eth-l2bd-{2Y}memif-{Y}pipe-{XY}drc-vppip4-mrr

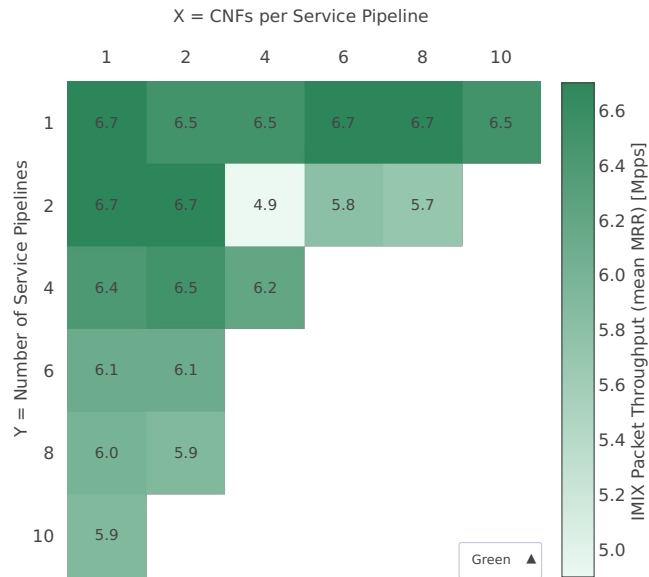

2n-skx-x710-ndr

64b-2t1c-eth-l2bd

**Throughput:** eth-l2bd-{2Y}memif-{Y}pipe-{XY}drc-vppip4-ndr

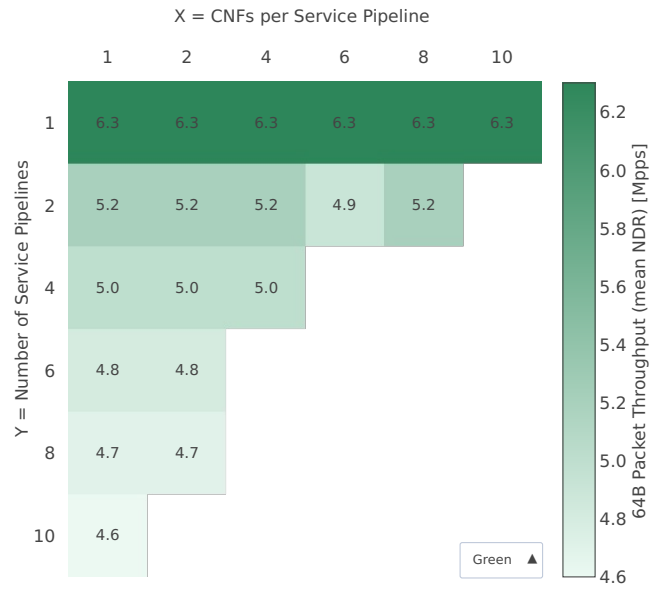

64b-4t2c-eth-l2bd

**Throughput:** eth-l2bd-{2Y}memif-{Y}pipe-{XY}drc-vppip4-ndr

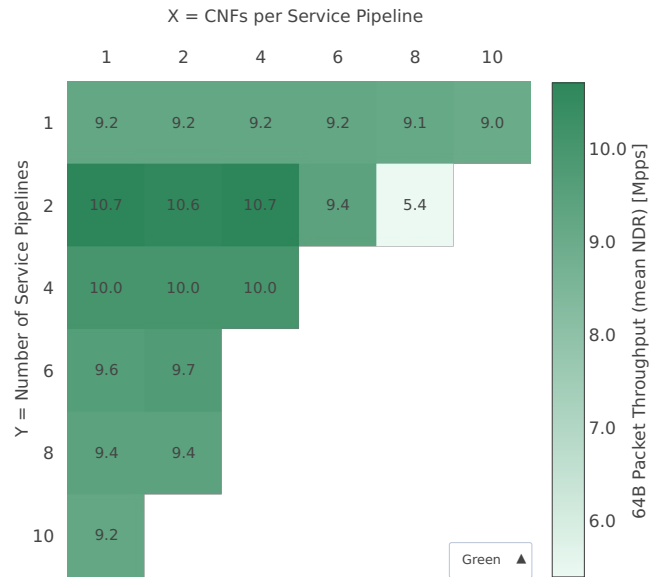



imix-2t1c-eth-l2bd

**Throughput:** eth-l2bd-{2Y}memif-{Y}pipe-{XY}drc-vppip4-ndr

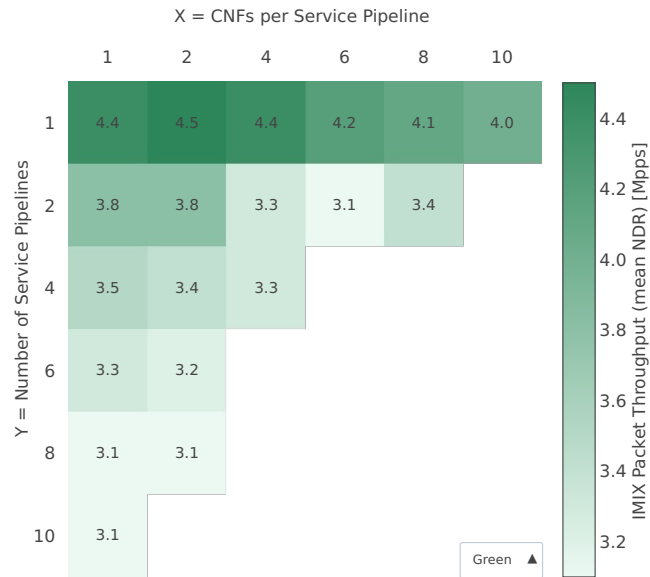

imix-4t2c-eth-l2bd

**Throughput:** eth-l2bd-{2Y}memif-{Y}pipe-{XY}drc-vppip4-ndr

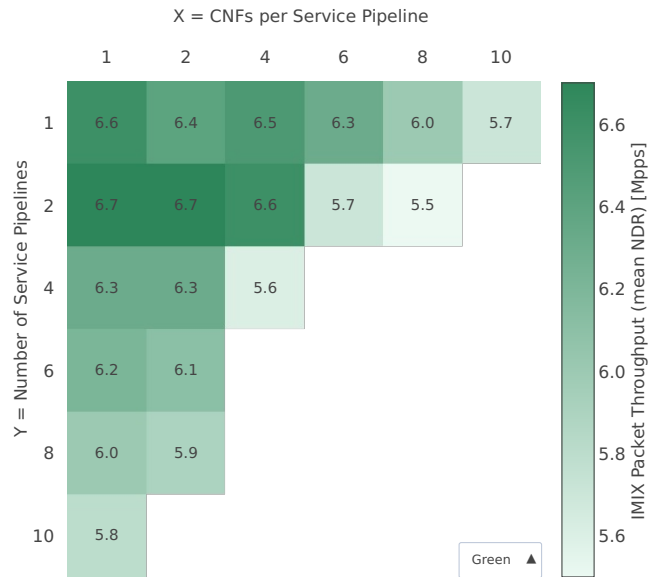

2n-skx-x710-pdr

64b-2t1c-eth-l2bd

**Throughput:** eth-l2bd-{2Y}memif-{Y}pipe-{XY}drc-vppip4-pdr

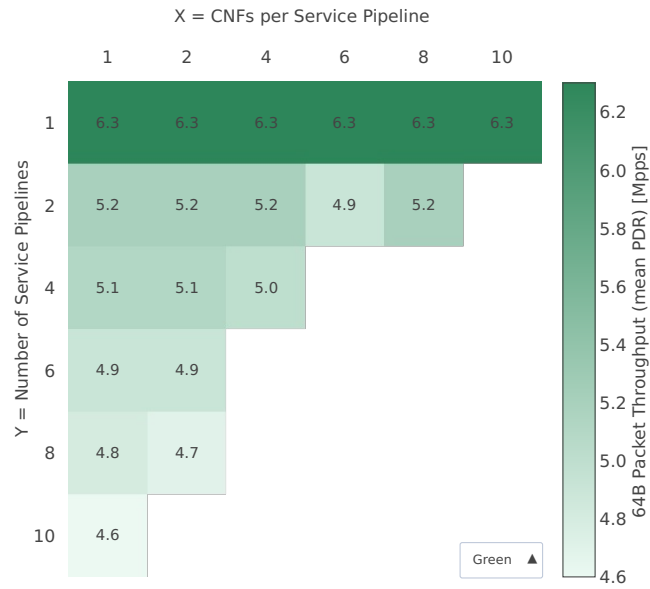

64b-4t2c-eth-l2bd

**Throughput:** eth-l2bd-{2Y}memif-{Y}pipe-{XY}drc-vppip4-pdr

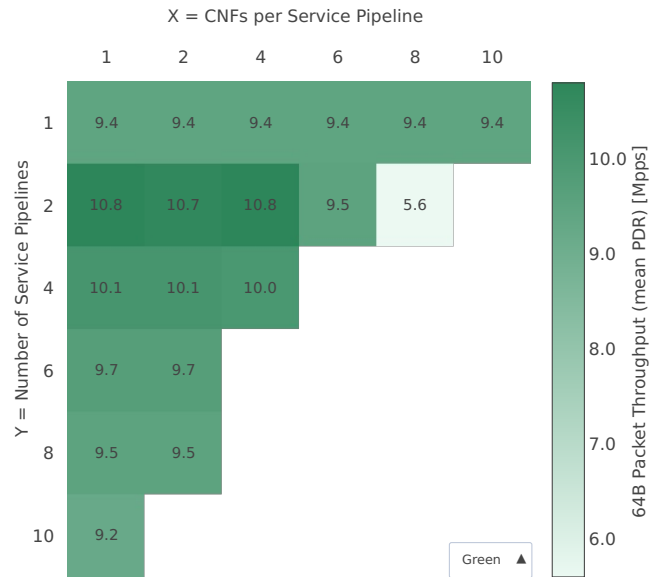

imix-2t1c-eth-l2bd

**Throughput:** eth-l2bd-{2Y}memif-{Y}pipe-{XY}drc-vppip4-pdr

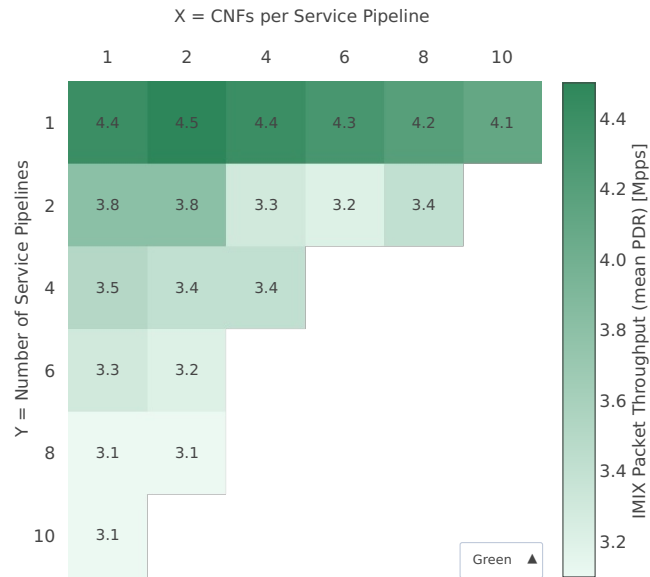

imix-4t2c-eth-l2bd

**Throughput:** eth-l2bd-{2Y}memif-{Y}pipe-{XY}drc-vppip4-pdr

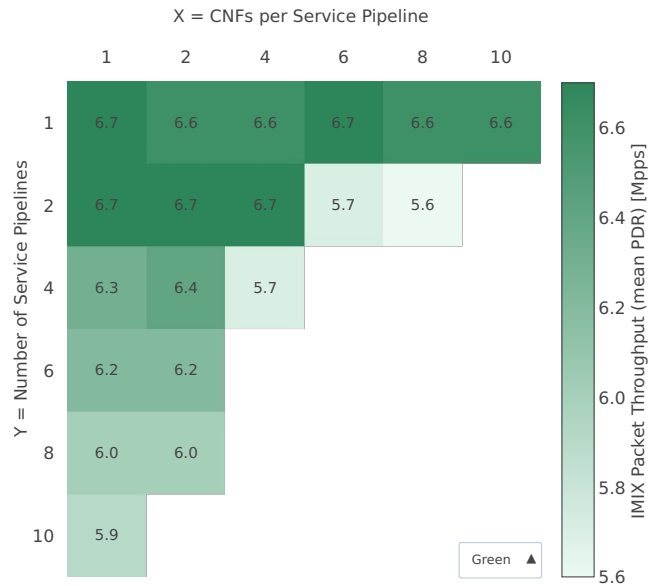

## 2.8 Comparisons

### 2.8.1 Current vs. Previous Release

Relative comparison of VPP packet throughput (NDR, PDR and MRR) between VPP-19.01 release and VPP-18.10 release (measured for CSIT-1901 and CSIT-1810 respectively) is calculated from results of tests running on 3-Node Intel Xeon Haswell testbeds (3n-hsw) in 1-core, 2-core and 4-core (MRR only) configurations.

Listed mean and standard deviation values are computed based on a series of the same tests executed against respective VPP releases to verify test results repeatability, with percentage change calculated for mean values. Note that the standard deviation is quite high for a small number of packet throughput tests, what indicates poor test results repeatability and makes the relative change of mean throughput value not fully representative for these tests. The root causes behind poor results repeatability vary between the test cases.

---

**Note:** Test results have been generated by

- [FD.io test executor vpp performance job 3n-hsw](#)<sup>81</sup>,
- [FD.io test executor vpp performance job 3n-skx](#)<sup>82</sup>,
- [FD.io test executor vpp performance job 2n-skx](#)<sup>83</sup>

with RF result files csit-vpp-perf-1901-\*.zip [archived here](#).

---

#### 3n-hsw

##### NDR Comparison

Comparison tables in ASCII and CSV formats:

- [ASCII 1t1c NDR comparison](#)
- [ASCII 2t2c NDR comparison](#)
- [CSV 1t1c NDR comparison](#)
- [CSV 2t2c NDR comparison](#)

##### PDR Comparison

Comparison tables in ASCII and CSV formats:

- [ASCII 1t1c PDR comparison](#)
- [ASCII 2t2c PDR comparison](#)
- [CSV 1t1c PDR comparison](#)
- [CSV 2t2c PDR comparison](#)

---

<sup>81</sup> <https://jenkins.fd.io/view/csit/job/csit-vpp-perf-verify-1901-3n-hsw>

<sup>82</sup> <https://jenkins.fd.io/view/csit/job/csit-vpp-perf-verify-1901-3n-skx>

<sup>83</sup> <https://jenkins.fd.io/view/csit/job/csit-vpp-perf-verify-1901-2n-skx>

### MRR Comparison

Comparison tables in ASCII and CSV formats:

- [ASCII 1t1c MRR comparison](#)
- [ASCII 2t2c MRR comparison](#)
- [ASCII 4t4c MRR comparison](#)
- [CSV 1t1c MRR comparison](#)
- [CSV 2t2c MRR comparison](#)
- [CSV 4t4c MRR comparison](#)

### 3n-skx

#### NDR Comparison

Comparison tables in ASCII and CSV formats:

- [ASCII 2t1c NDR comparison](#)
- [ASCII 4t2c NDR comparison](#)
- [CSV 2t1c NDR comparison](#)
- [CSV 4t2c NDR comparison](#)

#### PDR Comparison

Comparison tables in ASCII and CSV formats:

- [ASCII 2t1c PDR comparison](#)
- [ASCII 4t2c PDR comparison](#)
- [CSV 2t1c PDR comparison](#)
- [CSV 4t2c PDR comparison](#)

### MRR Comparison

Comparison tables in ASCII and CSV formats:

- [ASCII 2t1c MRR comparison](#)
- [ASCII 4t2c MRR comparison](#)
- [ASCII 8t4c MRR comparison](#)
- [CSV 2t1c MRR comparison](#)
- [CSV 4t2c MRR comparison](#)
- [CSV 8t4c MRR comparison](#)

### 2n-skx

#### NDR Comparison

Comparison tables in ASCII and CSV formats:



- [ASCII 2t1c NDR comparison](#)
- [ASCII 4t2c NDR comparison](#)
- [CSV 2t1c NDR comparison](#)
- [CSV 4t2c NDR comparison](#)

### PDR Comparison

Comparison tables in ASCII and CSV formats:

- [ASCII 2t1c PDR comparison](#)
- [ASCII 4t2c PDR comparison](#)
- [CSV 2t1c PDR comparison](#)
- [CSV 4t2c PDR comparison](#)

### MRR Comparison

Comparison tables in ASCII and CSV formats:

- [ASCII 2t1c MRR comparison](#)
- [ASCII 4t2c MRR comparison](#)
- [ASCII 8t4c MRR comparison](#)
- [CSV 2t1c MRR comparison](#)
- [CSV 4t2c MRR comparison](#)
- [CSV 8t4c MRR comparison](#)

## 2.8.2 3n-Skx vs. 3n-Hsw Testbeds

Relative comparison of VPP-19.01 release packet throughput (NDR, PDR and MRR) is calculated for the same tests executed on 3-Node Skylake (3n-skx) and 3-Node Haswell (3n-hsw) physical testbed types, in 1-core, 2-core and 4-core configurations.

---

**Note:** Test results have been generated by [FD.io test executor vpp performance job 3n-hsw](#)<sup>84</sup> and [FD.io test executor vpp performance job 3n-skx](#)<sup>85</sup> with RF result files csit-vpp-perf-1901-\*.zip [archived here](#).

---

### NDR Comparison

Comparison tables in ASCII and CSV formats:

- [ASCII 1c NDR comparison](#)
- [ASCII 2c NDR comparison](#)
- [CSV 1c NDR comparison](#)
- [CSV 2c NDR comparison](#)

---

<sup>84</sup> <https://jenkins.fd.io/view/csit/job/csit-vpp-perf-verify-1901-3n-hsw>

<sup>85</sup> <https://jenkins.fd.io/view/csit/job/csit-vpp-perf-verify-1901-3n-skx>

### PDR Comparison

Comparison tables in ASCII and CSV formats:

- [ASCII 1c PDR comparison](#)
- [ASCII 2c PDR comparison](#)
- [CSV 1c PDR comparison](#)
- [CSV 2c PDR comparison](#)

### MRR Comparison

Comparison tables in ASCII and CSV formats:

- [ASCII 1c MRR comparison](#)
- [ASCII 2c MRR comparison](#)
- [ASCII 4c MRR comparison](#)
- [CSV 1c MRR comparison](#)
- [CSV 2c MRR comparison](#)
- [CSV 4c MRR comparison](#)

### 2.8.3 3n-Skx vs. 2n-Skx Testbeds

Relative comparison of VPP-19.01 release packet throughput (NDR, PDR and MRR) is calculated for the same tests executed on 3-Node Skylake (3n- skx) and 2-Node Skylake (2n-skx) physical testbed types, in 1-core, 2-core and 4-core configurations.

---

**Note:** Test results have been generated by [FD.io test executor vpp performance job 3n-skx<sup>86</sup>](#) and [FD.io test executor vpp performance job 2n-skx<sup>87</sup>](#) with RF result files csit-vpp-perf-1901-\*.zip [archived here](#).

---

### NDR Comparison

Comparison tables in ASCII and CSV formats:

- [ASCII 1c NDR comparison](#)
- [ASCII 2c NDR comparison](#)
- [CSV 1c NDR comparison](#)
- [CSV 2c NDR comparison](#)

### PDR Comparison

Comparison tables in ASCII and CSV formats:

- [ASCII 1c PDR comparison](#)
- [ASCII 1c PDR comparison](#)
- [CSV 2c PDR comparison](#)
- [CSV 2c PDR comparison](#)

---

<sup>86</sup> <https://jenkins.fd.io/view/csit/job/csit-vpp-perf-verify-1901-3n-skx>

<sup>87</sup> <https://jenkins.fd.io/view/csit/job/csit-vpp-perf-verify-1901-2n-skx>

## MRR Comparison

Comparison tables in ASCII and CSV formats:

- [ASCII 1c MRR comparison](#)
- [ASCII 2c MRR comparison](#)
- [ASCII 4c MRR comparison](#)
- [CSV 1c MRR comparison](#)
- [CSV 2c MRR comparison](#)
- [CSV 4c MRR comparison](#)

## 2.8.4 NICs Comparison

Relative comparison of VPP packet throughput (NDR, PDR and MRR) between NICs (measured for |csit-release) is calculated from results of tests running on 3-Node Intel Xeon Haswell testbeds (3n-hsw) in 1-core, 2-core and 4-core (MRR only) configurations.

Listed mean and standard deviation values are computed based on a series of the same tests executed against respective VPP releases to verify test results repeatability, with percentage change calculated for mean values. Note that the standard deviation is quite high for a small number of packet throughput tests, what indicates poor test results repeatability and makes the relative change of mean throughput value not fully representative for these tests. The root causes behind poor results repeatability vary between the test cases.

---

**Note:** Test results have been generated by

- [FD.io test executor vpp performance job 3n-hsw<sup>88</sup>](#),
- [FD.io test executor vpp performance job 3n-skx<sup>89</sup>](#),
- [FD.io test executor vpp performance job 2n-skx<sup>90</sup>](#)

with RF result files csit-vpp-perf-1901-\*.zip [archived here](#).

---

### 3n-hsw

#### NDR Comparison

Comparison tables in ASCII and CSV formats:

- [ASCII 1t1c NDR Intel-x520 and Intel-x710 comparison](#)
- [ASCII 2t2c NDR Intel-x520 and Intel-x710 comparison](#)
- [CSV 1t1c NDR Intel-x520 and Intel-x710 comparison](#)
- [CSV 2t2c NDR Intel-x520 and Intel-x710 comparison](#)

#### PDR Comparison

Comparison tables in ASCII and CSV formats:

- [ASCII 1t1c PDR Intel-x520 and Intel-x710 comparison](#)

---

<sup>88</sup> <https://jenkins.fd.io/view/csit/job/csit-vpp-perf-verify-1901-3n-hsw>

<sup>89</sup> <https://jenkins.fd.io/view/csit/job/csit-vpp-perf-verify-1901-3n-skx>

<sup>90</sup> <https://jenkins.fd.io/view/csit/job/csit-vpp-perf-verify-1901-2n-skx>

- ASCII 2t2c PDR Intel-x520 and Intel-x710 comparison
- CSV 1t1c PDR Intel-x520 and Intel-x710 comparison
- CSV 2t2c PDR Intel-x520 and Intel-x710 comparison

### **MRR Comparison**

Comparison tables in ASCII and CSV formats:

- ASCII 1t1c MRR Intel-x520 and Intel-x710 comparison
- ASCII 2t2c MRR Intel-x520 and Intel-x710 comparison
- ASCII 4t4c MRR Intel-x520 and Intel-x710 comparison
- CSV 1t1c MRR Intel-x520 and Intel-x710 comparison
- CSV 2t2c MRR Intel-x520 and Intel-x710 comparison
- CSV 4t4c MRR Intel-x520 and Intel-x710 comparison

### **3n-skx**

### **NDR Comparison**

Comparison tables in ASCII and CSV formats:

- ASCII 2t1c NDR Intel-x710 and Intel-xxv710 comparison
- ASCII 4t2c NDR Intel-x710 and Intel-xxv710 comparison
- CSV 2t1c NDR Intel-x710 and Intel-xxv710 comparison
- CSV 4t2c NDR Intel-x710 and Intel-xxv710 comparison

### **PDR Comparison**

Comparison tables in ASCII and CSV formats:

- ASCII 2t1c PDR Intel-x710 and Intel-xxv710 comparison
- ASCII 4t2c PDR Intel-x710 and Intel-xxv710 comparison
- CSV 2t1c PDR Intel-x710 and Intel-xxv710 comparison
- CSV 4t2c PDR Intel-x710 and Intel-xxv710 comparison

### **MRR Comparison**

Comparison tables in ASCII and CSV formats:

- ASCII 2t1c MRR Intel-x710 and Intel-xxv710 comparison
- ASCII 4t2c MRR Intel-x710 and Intel-xxv710 comparison
- ASCII 8t4c MRR Intel-x710 and Intel-xxv710 comparison
- CSV 2t1c MRR Intel-x710 and Intel-xxv710 comparison
- CSV 4t2c MRR Intel-x710 and Intel-xxv710 comparison
- CSV 8t4c MRR Intel-x710 and Intel-xxv710 comparison

## 2n-skx

### NDR Comparison

Comparison tables in ASCII and CSV formats:

- [ASCII 2t1c NDR Intel-x710 and Intel-xxv710 comparison](#)
- [ASCII 4t2c NDR Intel-x710 and Intel-xxv710 comparison](#)
- [CSV 2t1c NDR Intel-x710 and Intel-xxv710 comparison](#)
- [CSV 4t2c NDR Intel-x710 and Intel-xxv710 comparison](#)

### PDR Comparison

Comparison tables in ASCII and CSV formats:

- [ASCII 2t1c PDR Intel-x710 and Intel-xxv710 comparison](#)
- [ASCII 4t2c PDR Intel-x710 and Intel-xxv710 comparison](#)
- [CSV 2t1c PDR Intel-x710 and Intel-xxv710 comparison](#)
- [CSV 4t2c PDR Intel-x710 and Intel-xxv710 comparison](#)

### MRR Comparison

Comparison tables in ASCII and CSV formats:

- [ASCII 2t1c MRR Intel-x710 and Intel-xxv710 comparison](#)
- [ASCII 4t2c MRR Intel-x710 and Intel-xxv710 comparison](#)
- [ASCII 8t4c MRR Intel-x710 and Intel-xxv710 comparison](#)
- [CSV 2t1c MRR Intel-x710 and Intel-xxv710 comparison](#)
- [CSV 4t2c MRR Intel-x710 and Intel-xxv710 comparison](#)
- [CSV 8t4c MRR Intel-x710 and Intel-xxv710 comparison](#)

## 2.9 Throughput Trending

In addition to reporting throughput comparison between VPP releases, CSIT provides continuous performance trending for VPP master branch:

1. [Performance Dashboard](#)<sup>91</sup>: per VPP test case throughput trend, trend compliance and summary of detected anomalies.
2. [Trending Methodology](#)<sup>92</sup>: throughput test metrics, trend calculations and anomaly classification (progression, regression).
3. [VPP Trendline Graphs](#)<sup>93</sup>: per VPP build MRR throughput measurements against the trendline with anomaly highlights and associated CSIT test jobs.

---

<sup>91</sup> <https://docs.fd.io/csit/master/trending/introduction/index.html>

<sup>92</sup> <https://docs.fd.io/csit/master/trending/methodology/index.html>

<sup>93</sup> <https://docs.fd.io/csit/master/trending/trending/index.html>

## 2.10 Test Environment

### 2.10.1 Physical Testbeds

FD.io CSIT performance tests are executed in physical testbeds hosted by LF for FD.io project. Two physical testbed topology types are used:

- **3-Node Topology:** Consisting of two servers acting as SUTs (Systems Under Test) and one server as TG (Traffic Generator), all connected in ring topology.
- **2-Node Topology:** Consisting of one server acting as SUTs and one server as TG both connected in ring topology.

Tested SUT servers are based on a range of processors including Intel Xeon Haswell-SP, Intel Xeon Skylake-SP, Arm, Intel Atom. More detailed description is provided in *Physical Testbeds* (page 4). Tested logical topologies are described in *Logical Topologies* (page 31).

### 2.10.2 Server Specifications

Complete technical specifications of compute servers used in CSIT physical testbeds are maintained on FD.io wiki pages: [CSIT/Testbeds: Xeon Hsw, VIRL](#)<sup>94</sup> and [CSIT Testbeds: Xeon Skx, Arm, Atom](#)<sup>95</sup>.

### 2.10.3 Pre-Test Server Calibration

Number of SUT server sub-system runtime parameters have been identified as impacting data plane performance tests. Calibrating those parameters is part of FD.io CSIT pre-test activities, and includes measuring and reporting following:

1. System level core jitter – measure duration of core interrupts by Linux in clock cycles and how often interrupts happen. Using [CPU core jitter tool](#)<sup>96</sup>.
2. Memory bandwidth – measure bandwidth with [Intel MLC tool](#)<sup>97</sup>.
3. Memory latency – measure memory latency with Intel MLC tool.
4. Cache latency at all levels (L1, L2, and Last Level Cache) – measure cache latency with Intel MLC tool.

Measured values of listed parameters are especially important for repeatable zero packet loss throughput measurements across multiple system instances. Generally they come useful as a background data for comparing data plane performance results across disparate servers.

Following sections include measured calibration data for Intel Xeon Haswell and Intel Xeon Skylake testbeds.

### 2.10.4 Calibration Data - Haswell

Following sections include sample calibration data measured on t1-sut1 server running in one of the Intel Xeon Haswell testbeds as specified in [CSIT/Testbeds: Xeon Hsw, VIRL](#)<sup>98</sup>.

Calibration data obtained from all other servers in Haswell testbeds shows the same or similar values.

<sup>94</sup> [https://wiki.fd.io/view/CSIT/Testbeds:\\_Xeon\\_Hsw,\\_VIRL.#FD.io\\_CSIT\\_testbeds\\_-\\_Xeon\\_Haswell.2C\\_VIRL](https://wiki.fd.io/view/CSIT/Testbeds:_Xeon_Hsw,_VIRL.#FD.io_CSIT_testbeds_-_Xeon_Haswell.2C_VIRL)

<sup>95</sup> [https://wiki.fd.io/view/CSIT/Testbeds:\\_Xeon\\_Skx,\\_Arm,\\_Atom.#Server\\_Specification](https://wiki.fd.io/view/CSIT/Testbeds:_Xeon_Skx,_Arm,_Atom.#Server_Specification)

<sup>96</sup> [https://git.fd.io/pma\\_tools/tree/jitter](https://git.fd.io/pma_tools/tree/jitter)

<sup>97</sup> <https://software.intel.com/en-us/articles/intelr-memory-latency-checker>

<sup>98</sup> [https://wiki.fd.io/view/CSIT/Testbeds:\\_Xeon\\_Hsw,\\_VIRL.#FD.io\\_CSIT\\_testbeds\\_-\\_Xeon\\_Haswell.2C\\_VIRL](https://wiki.fd.io/view/CSIT/Testbeds:_Xeon_Hsw,_VIRL.#FD.io_CSIT_testbeds_-_Xeon_Haswell.2C_VIRL)

## Linux cmdline

```
$ cat /proc/cmdline
BOOT_IMAGE=/vmlinuz-4.15.0-36-generic root=UUID=5d2ecc97-245b-4e94-b0ae-c3548567de19 ro isolcpus=1-
↪17,19-35 nohz_full=1-17,19-35 rcu_nocbs=1-17,19-35 numa_balancing=disable intel_pstate=disable_
↪intel_iommu=on iommu=pt nmi_watchdog=0 audit=0 nosoftlockup processor.max_cstate=1 intel_idle.max_
↪cstate=1 hpet=disable tsc=reliable mce=off console=tty0 console=ttyS0,115200n8
```

## Linux uname

```
$ uname -a
Linux t1-tg1 4.15.0-36-generic #39-Ubuntu SMP Mon Sep 24 16:19:09 UTC 2018 x86_64 x86_64 x86_64 GNU/
↪Linux
```

## System-level Core Jitter

```
$ sudo taskset -c 3 /home/testuser/pma_tools/jitter/jitter -i 30
Linux Jitter testing program version 1.8
Iterations=30
The program will execute a dummy function 80000 times
Display is updated every 20000 displayUpdate intervals
Timings are in CPU Core cycles
Inst_Min:   Minimum Excution time during the display update interval(default is ~1 second)
Inst_Max:   Maximum Excution time during the display update interval(default is ~1 second)
Inst_jitter: Jitter in the Excution time during rhe display update interval. This is the value of _
↪interest
last_Exec:  The Excution time of last iteration just before the display update
Abs_Min:   Absolute Minimum Excution time since the program started or statistics were reset
Abs_Max:   Absolute Maximum Excution time since the program started or statistics were reset
tmp:       Cumulative value calcaulted by the dummy function
Interval:  Time interval between the display updates in Core Cycles
Sample No: Sample number
```

Inst_Min	Inst_Max	Inst_jitter	last_Exec	Abs_min	Abs_max	tmp	Interval	
↪Sample No								
160024	172636	12612	160028	160024	172636	1573060608	3205463144	↪
↪1								
160024	188236	28212	160028	160024	188236	958595072	3205500844	↪
↪2								
160024	185676	25652	160028	160024	188236	344129536	3205485976	↪
↪3								
160024	172608	12584	160024	160024	188236	4024631296	3205472740	↪
↪4								
160024	179260	19236	160028	160024	188236	3410165760	3205502164	↪
↪5								
160024	172432	12408	160024	160024	188236	2795700224	3205452036	↪
↪6								
160024	178820	18796	160024	160024	188236	2181234688	3205455408	↪
↪7								
160024	172512	12488	160028	160024	188236	1566769152	3205461528	↪
↪8								
160024	172636	12612	160028	160024	188236	952303616	3205478820	↪
↪9								
160024	173676	13652	160028	160024	188236	337838080	3205470412	↪
↪10								
160024	178776	18752	160028	160024	188236	4018339840	3205481472	↪
↪11								
160024	172788	12764	160028	160024	188236	3403874304	3205492336	↪
↪12								

(continues on next page)

(continued from previous page)

	160024	174616	14592	160028	160024	188236	2789408768	3205474904	┆
↔13	160024	174440	14416	160028	160024	188236	2174943232	3205479448	┆
↔14	160024	178748	18724	160024	160024	188236	1560477696	3205482668	┆
↔15	160024	172588	12564	169404	160024	188236	946012160	3205510496	┆
↔16	160024	172636	12612	160024	160024	188236	331546624	3205472204	┆
↔17	160024	172480	12456	160024	160024	188236	4012048384	3205455864	┆
↔18	160024	172740	12716	160028	160024	188236	3397582848	3205464932	┆
↔19	160024	179200	19176	160028	160024	188236	2783117312	3205476012	┆
↔20	160024	172480	12456	160028	160024	188236	2168651776	3205465632	┆
↔21	160024	172728	12704	160024	160024	188236	1554186240	3205497204	┆
↔22	160024	172620	12596	160028	160024	188236	939720704	3205466972	┆
↔23	160024	172640	12616	160028	160024	188236	325255168	3205471216	┆
↔24	160024	172484	12460	160028	160024	188236	4005756928	3205467388	┆
↔25	160024	172636	12612	160028	160024	188236	3391291392	3205482748	┆
↔26	160024	179056	19032	160024	160024	188236	2776825856	3205467152	┆
↔27	160024	172672	12648	160024	160024	188236	2162360320	3205483268	┆
↔28	160024	176932	16908	160024	160024	188236	1547894784	3205488536	┆
↔29	160024	172452	12428	160028	160024	188236	933429248	3205440636	┆
↔30									

### Memory Bandwidth

```
$ sudo /home/testuser/mlc --bandwidth_matrix
Intel(R) Memory Latency Checker - v3.5
Command line parameters: --bandwidth_matrix

Using buffer size of 100.000MB/thread for reads and an additional 100.000MB/thread for writes
Measuring Memory Bandwidths between nodes within system
Bandwidths are in MB/sec (1 MB/sec = 1,000,000 Bytes/sec)
Using all the threads from each core if Hyper-threading is enabled
Using Read-only traffic type
      Numa node
Numa node    0      1
0           57935.5  30265.2
1           30284.6  58409.9
```

```
$ sudo /home/testuser/mlc --peak_injection_bandwidth
Intel(R) Memory Latency Checker - v3.5
Command line parameters: --peak_injection_bandwidth

Using buffer size of 100.000MB/thread for reads and an additional 100.000MB/thread for writes
```

(continues on next page)



(continued from previous page)

```

Measuring Peak Injection Memory Bandwidths for the system
Bandwidths are in MB/sec (1 MB/sec = 1,000,000 Bytes/sec)
Using all the threads from each core if Hyper-threading is enabled
Using traffic with the following read-write ratios
ALL Reads      : 115762.2
3:1 Reads-Writes : 106242.2
2:1 Reads-Writes : 103031.8
1:1 Reads-Writes : 87943.7
Stream-triad like: 100048.4

```

```

$ sudo /home/testuser/mlc --max_bandwidth
Intel(R) Memory Latency Checker - v3.5
Command line parameters: --max_bandwidth

Using buffer size of 100.000MB/thread for reads and an additional 100.000MB/thread for writes

Measuring Maximum Memory Bandwidths for the system
Will take several minutes to complete as multiple injection rates will be tried to get the best_
↔_bandwidth
Bandwidths are in MB/sec (1 MB/sec = 1,000,000 Bytes/sec)
Using all the threads from each core if Hyper-threading is enabled
Using traffic with the following read-write ratios
ALL Reads      : 115782.41
3:1 Reads-Writes : 105965.78
2:1 Reads-Writes : 103162.38
1:1 Reads-Writes : 88255.82
Stream-triad like: 105608.10

```

## Memory Latency

```

$ sudo /home/testuser/mlc --latency_matrix
Intel(R) Memory Latency Checker - v3.5
Command line parameters: --latency_matrix

Using buffer size of 200.000MB
Measuring idle latencies (in ns)...

```

	Numa node	
Numa node	0	1
0	101.0	132.0
1	141.2	98.8

```

$ sudo /home/testuser/mlc --idle_latency
Intel(R) Memory Latency Checker - v3.5
Command line parameters: --idle_latency

Using buffer size of 200.000MB
Each iteration took 227.2 core clocks ( 99.0 ns)

```

```

$ sudo /home/testuser/mlc --loaded_latency
Intel(R) Memory Latency Checker - v3.5
Command line parameters: --loaded_latency

Using buffer size of 100.000MB/thread for reads and an additional 100.000MB/thread for writes

Measuring Loaded Latencies for the system
Using all the threads from each core if Hyper-threading is enabled
Using Read-only traffic type
Inject Latency Bandwidth

```

(continues on next page)

(continued from previous page)

Delay	(ns)	MB/sec
00000	294.08	115841.6
00002	294.27	115851.5
00008	293.67	115821.8
00015	278.92	115587.5
00050	246.80	113991.2
00100	206.86	104508.1
00200	123.72	72873.6
00300	113.35	52641.1
00400	108.89	41078.9
00500	108.11	33699.1
00700	106.19	24878.0
01000	104.75	17948.1
01300	103.72	14089.0
01700	102.95	11013.6
02500	102.25	7756.3
03500	101.81	5749.3
05000	101.46	4230.4
09000	101.05	2641.4
20000	100.77	1542.5

### L1/L2/LLC Latency

```
$ sudo /home/testuser/mlc --c2c_latency
Intel(R) Memory Latency Checker - v3.5
Command line parameters: --c2c_latency

Measuring cache-to-cache transfer latency (in ns)...
Local Socket L2->L2 HIT latency      42.1
Local Socket L2->L2 HITM latency     47.0
Remote Socket L2->L2 HITM latency (data address homed in writer socket)
      Reader Numa Node
Writer Numa Node   0      1
                  0      - 108.0
                  1    106.9   -
Remote Socket L2->L2 HITM latency (data address homed in reader socket)
      Reader Numa Node
Writer Numa Node   0      1
                  0      - 107.7
                  1    106.6   -
```

### Spectre and Meltdown Checks

Following section displays the output of a running shell script to tell if system is vulnerable against the several “speculative execution” CVEs that were made public in 2018. Script is available on [Spectre & Meltdown Checker Github](#)<sup>99</sup>.

- CVE-2017-5753 [bounds check bypass] aka ‘Spectre Variant 1’
- CVE-2017-5715 [branch target injection] aka ‘Spectre Variant 2’
- CVE-2017-5754 [rogue data cache load] aka ‘Meltdown’ aka ‘Variant 3’
- CVE-2018-3640 [rogue system register read] aka ‘Variant 3a’
- CVE-2018-3639 [speculative store bypass] aka ‘Variant 4’
- CVE-2018-3615 [L1 terminal fault] aka ‘Foreshadow (SGX)’

<sup>99</sup> <https://github.com/speed47/spectre-meltdown-checker>

- CVE-2018-3620 [L1 terminal fault] aka 'Foreshadow-NG (OS)'
- CVE-2018-3646 [L1 terminal fault] aka 'Foreshadow-NG (VMM)'

```

$ sudo ./spectre-meltdown-checker.sh --no-color

Spectre and Meltdown mitigation detection tool v0.40

Checking for vulnerabilities on current system
Kernel is Linux 4.15.0-36-generic #39-Ubuntu SMP Mon Sep 24 16:19:09 UTC 2018 x86_64
CPU is Intel(R) Xeon(R) CPU E5-2699 v3 @ 2.30GHz

Hardware check
* Hardware support (CPU microcode) for mitigation techniques
  * Indirect Branch Restricted Speculation (IBRS)
    * SPEC_CTRL MSR is available: YES
    * CPU indicates IBRS capability: YES (SPEC_CTRL feature bit)
  * Indirect Branch Prediction Barrier (IBPB)
    * PRED_CMD MSR is available: YES
    * CPU indicates IBPB capability: YES (SPEC_CTRL feature bit)
  * Single Thread Indirect Branch Predictors (STIBP)
    * SPEC_CTRL MSR is available: YES
    * CPU indicates STIBP capability: YES (Intel STIBP feature bit)
  * Speculative Store Bypass Disable (SSBD)
    * CPU indicates SSBD capability: YES (Intel SSBD)
  * L1 data cache invalidation
    * FLUSH_CMD MSR is available: YES
    * CPU indicates L1D flush capability: YES (L1D flush feature bit)
  * Enhanced IBRS (IBRS_ALL)
    * CPU indicates ARCH_CAPABILITIES MSR availability: NO
    * ARCH_CAPABILITIES MSR advertises IBRS_ALL capability: NO
  * CPU explicitly indicates not being vulnerable to Meltdown (RDCL_NO): NO
  * CPU explicitly indicates not being vulnerable to Variant 4 (SSB_NO): NO
  * CPU/Hypervisor indicates L1D flushing is not necessary on this system: NO
  * Hypervisor indicates host CPU might be vulnerable to RSB underflow (RSBA): NO
  * CPU supports Software Guard Extensions (SGX): NO
  * CPU microcode is known to cause stability problems: NO (model 0x3f family 0x6 stepping 0x2_
↳ ucode 0x3d cpuid 0x306f2)
    * CPU microcode is the latest known available version: YES (latest version is 0x3d dated 2018/04/
↳ 20 according to builtin MCEExtractor DB v84 - 2018/09/27)
* CPU vulnerability to the speculative execution attack variants
  * Vulnerable to CVE-2017-5753 (Spectre Variant 1, bounds check bypass): YES
  * Vulnerable to CVE-2017-5715 (Spectre Variant 2, branch target injection): YES
  * Vulnerable to CVE-2017-5754 (Variant 3, Meltdown, rogue data cache load): YES
  * Vulnerable to CVE-2018-3640 (Variant 3a, rogue system register read): YES
  * Vulnerable to CVE-2018-3639 (Variant 4, speculative store bypass): YES
  * Vulnerable to CVE-2018-3615 (Foreshadow (SGX), L1 terminal fault): NO
  * Vulnerable to CVE-2018-3620 (Foreshadow-NG (OS), L1 terminal fault): YES
  * Vulnerable to CVE-2018-3646 (Foreshadow-NG (VMM), L1 terminal fault): YES

CVE-2017-5753 aka 'Spectre Variant 1, bounds check bypass'
* Mitigated according to the /sys interface: YES (Mitigation: __user pointer sanitization)
* Kernel has array_index_mask_nospec: YES (1 occurrence(s) found of x86 64 bits array_index_mask_
↳ nospec())
* Kernel has the Red Hat/Ubuntu patch: NO
* Kernel has mask_nospec64 (arm64): NO
> STATUS: NOT VULNERABLE (Mitigation: __user pointer sanitization)

CVE-2017-5715 aka 'Spectre Variant 2, branch target injection'
* Mitigated according to the /sys interface: YES (Mitigation: Full generic retpoline, IBPB, IBRS_FW)
* Mitigation 1
  * Kernel is compiled with IBRS support: YES
    * IBRS enabled and active: YES (for kernel and firmware code)

```

(continues on next page)

(continued from previous page)

```

* Kernel is compiled with IBPB support: YES
  * IBPB enabled and active: YES
* Mitigation 2
  * Kernel has branch predictor hardening (arm): NO
  * Kernel compiled with retpoline option: YES
    * Kernel compiled with a retpoline-aware compiler: YES (kernel reports full retpoline_
↳ compilation)
> STATUS: NOT VULNERABLE (Full retpoline + IBPB are mitigating the vulnerability)

CVE-2017-5754 aka 'Variant 3, Meltdown, rogue data cache load'
* Mitigated according to the /sys interface: YES (Mitigation: PTI)
* Kernel supports Page Table Isolation (PTI): YES
  * PTI enabled and active: YES
  * Reduced performance impact of PTI: YES (CPU supports INVPCID, performance impact of PTI will be_
↳ greatly reduced)
* Running as a Xen PV DomU: NO
> STATUS: NOT VULNERABLE (Mitigation: PTI)

CVE-2018-3640 aka 'Variant 3a, rogue system register read'
* CPU microcode mitigates the vulnerability: YES
> STATUS: NOT VULNERABLE (your CPU microcode mitigates the vulnerability)

CVE-2018-3639 aka 'Variant 4, speculative store bypass'
* Mitigated according to the /sys interface: YES (Mitigation: Speculative Store Bypass disabled via_
↳ prctl and seccomp)
* Kernel supports speculation store bypass: YES (found in /proc/self/status)
> STATUS: NOT VULNERABLE (Mitigation: Speculative Store Bypass disabled via prctl and seccomp)

CVE-2018-3615 aka 'Foreshadow (SGX), L1 terminal fault'
* CPU microcode mitigates the vulnerability: N/A
> STATUS: NOT VULNERABLE (your CPU vendor reported your CPU model as not vulnerable)

CVE-2018-3620 aka 'Foreshadow-NG (OS), L1 terminal fault'
* Mitigated according to the /sys interface: YES (Mitigation: PTE Inversion)
* Kernel supports PTE inversion: YES (found in kernel image)
* PTE inversion enabled and active: YES
> STATUS: NOT VULNERABLE (Mitigation: PTE Inversion)

CVE-2018-3646 aka 'Foreshadow-NG (VMM), L1 terminal fault'
* Information from the /sys interface: VMX: conditional cache flushes, SMT disabled
* This system is a host running an hypervisor: NO
* Mitigation 1 (KVM)
  * EPT is disabled: NO
* Mitigation 2
  * L1D flush is supported by kernel: YES (found flush_l1d in /proc/cpuinfo)
  * L1D flush enabled: YES (conditional flushes)
  * Hardware-backed L1D flush supported: YES (performance impact of the mitigation will be greatly_
↳ reduced)
  * Hyper-Threading (SMT) is enabled: NO
> STATUS: NOT VULNERABLE (this system is not running an hypervisor)

> SUMMARY: CVE-2017-5753:OK CVE-2017-5715:OK CVE-2017-5754:OK CVE-2018-3640:OK CVE-2018-3639:OK CVE-
↳ 2018-3615:OK CVE-2018-3620:OK CVE-2018-3646:OK

Need more detailed information about mitigation options? Use --explain
A false sense of security is worse than no security at all, see --disclaimer

```

## 2.10.5 Calibration Data - Skylake

Following sections include sample calibration data measured on s11-t31-sut1 server running in one of the Intel Xeon Skylake testbeds as specified in [CSIT Testbeds: Xeon Skx, Arm, Atom<sup>100</sup>](#).

Calibration data obtained from all other servers in Skylake testbeds shows the same or similar values.

### Linux cmdline

```
$ cat /proc/cmdline
BOOT_IMAGE=/vmlinuz-4.15.0-23-generic root=UUID=759ad671-ad46-441b-a75b-9f54e81837bb ro isolcpus=1-
↪27,29-55,57-83,85-111 nohz_full=1-27,29-55,57-83,85-111 rcu_nocbs=1-27,29-55,57-83,85-111 numa_
↪balancing=disable intel_pstate=disable intel_iommu=on iommu=pt nmi_watchdog=0 audit=0_
↪nosoftlockup processor.max_cstate=1 intel_idle.max_cstate=1 hpet=disable tsc=reliable mce=off_
↪console=tty0 console=ttyS0,115200n8
```

### Linux uname

```
$ uname -a
Linux s5-t22-sut1 4.15.0-23-generic #25-Ubuntu SMP Wed May 23 18:02:16 UTC 2018 x86_64 x86_64 x86_
↪64 GNU/Linux
```

### System-level Core Jitter

```
$ sudo taskset -c 3 /home/testuser/pma_tools/jitter/jitter -i 20
Linux Jitter testing program version 1.8
Iterations=20
The program will execute a dummy function 80000 times
Display is updated every 20000 displayUpdate intervals
Timings are in CPU Core cycles
Inst_Min:   Minimum Execution time during the display update interval(default is ~1 second)
Inst_Max:   Maximum Execution time during the display update interval(default is ~1 second)
Inst_jitter: Jitter in the Execution time during the display update interval. This is the value of_
↪interest
last_Exec:  The Execution time of last iteration just before the display update
Abs_Min:   Absolute Minimum Execution time since the program started or statistics were reset
Abs_Max:   Absolute Maximum Execution time since the program started or statistics were reset
tmp:       Cumulative value calculated by the dummy function
Interval:  Time interval between the display updates in Core Cycles
Sample No: Sample number
```

Inst_Min	Inst_Max	Inst_jitter	last_Exec	Abs_min	Abs_max	tmp	Interval
↪Sample No							
160022	171330	11308	160022	160022	171330	2538733568	3204142750
↪1							
160022	167294	7272	160026	160022	171330	328335360	3203873548
↪2							
160022	167560	7538	160026	160022	171330	2412904448	3203878736
↪3							
160022	169000	8978	160024	160022	171330	202506240	3203864588
↪4							
160022	166572	6550	160026	160022	171330	2287075328	3203866224
↪5							
160022	167460	7438	160026	160022	171330	76677120	3203854632
↪6							
160022	168134	8112	160024	160022	171330	2161246208	3203874674
↪7							

(continues on next page)

<sup>100</sup> [https://wiki.fd.io/view/CSIT/Testbeds:\\_Xeon\\_Skx,\\_Arm,\\_Atom.#Server\\_Specification](https://wiki.fd.io/view/CSIT/Testbeds:_Xeon_Skx,_Arm,_Atom.#Server_Specification)

(continued from previous page)

	160022	169094	9072	160022	160022	171330	4245815296	3203878798	↵
↵8	160022	172460	12438	160024	160022	172460	2035417088	3204112010	↵
↵9	160022	167862	7840	160030	160022	172460	4119986176	3203856800	↵
↵10	160022	168398	8376	160024	160022	172460	1909587968	3203854192	↵
↵11	160022	167548	7526	160024	160022	172460	3994157056	3203847442	↵
↵12	160022	167562	7540	160026	160022	172460	1783758848	3203862936	↵
↵13	160022	167604	7582	160024	160022	172460	3868327936	3203859346	↵
↵14	160022	168262	8240	160024	160022	172460	1657929728	3203851120	↵
↵15	160022	169700	9678	160024	160022	172460	3742498816	3203877690	↵
↵16	160022	170476	10454	160026	160022	172460	1532100608	3204088480	↵
↵17	160022	167798	7776	160024	160022	172460	3616669696	3203862072	↵
↵18	160022	166540	6518	160024	160022	172460	1406271488	3203836904	↵
↵19	160022	167516	7494	160024	160022	172460	3490840576	3203848120	↵
↵20									

### Memory Bandwidth

```
$ sudo /home/testuser/mlc --bandwidth_matrix
Intel(R) Memory Latency Checker - v3.5
Command line parameters: --bandwidth_matrix

Using buffer size of 100.000MB/thread for reads and an additional 100.000MB/thread for writes
Measuring Memory Bandwidths between nodes within system
Bandwidths are in MB/sec (1 MB/sec = 1,000,000 Bytes/sec)
Using all the threads from each core if Hyper-threading is enabled
Using Read-only traffic type
      Numa node
Numa node  0      1
0          107947.7  50951.5
1          50834.6  108183.4
```

```
$ sudo /home/testuser/mlc --peak_injection_bandwidth
Intel(R) Memory Latency Checker - v3.5
Command line parameters: --peak_injection_bandwidth

Using buffer size of 100.000MB/thread for reads and an additional 100.000MB/thread for writes

Measuring Peak Injection Memory Bandwidths for the system
Bandwidths are in MB/sec (1 MB/sec = 1,000,000 Bytes/sec)
Using all the threads from each core if Hyper-threading is enabled
Using traffic with the following read-write ratios
ALL Reads      : 215733.9
3:1 Reads-Writes : 182141.9
2:1 Reads-Writes : 178615.7
1:1 Reads-Writes : 149911.3
Stream-triad like: 159533.6
```

```

$ sudo /home/testuser/mlc --max_bandwidth
Intel(R) Memory Latency Checker - v3.5
Command line parameters: --max_bandwidth

Using buffer size of 100.000MB/thread for reads and an additional 100.000MB/thread for writes

Measuring Maximum Memory Bandwidths for the system
Will take several minutes to complete as multiple injection rates will be tried to get the best_
↪bandwidth
Bandwidths are in MB/sec (1 MB/sec = 1,000,000 Bytes/sec)
Using all the threads from each core if Hyper-threading is enabled
Using traffic with the following read-write ratios
ALL Reads      : 216875.73
3:1 Reads-Writes : 182615.14
2:1 Reads-Writes : 178745.67
1:1 Reads-Writes : 149485.27
Stream-triad like: 180057.87

```

## Memory Latency

```

$ sudo /home/testuser/mlc --latency_matrix
Intel(R) Memory Latency Checker - v3.5
Command line parameters: --latency_matrix

Using buffer size of 2000.000MB
Measuring idle latencies (in ns)...
          Numa node
Numa node  0      1
          0      81.4 131.1
          1     131.1 81.3

```

```

$ sudo /home/testuser/mlc --idle_latency
Intel(R) Memory Latency Checker - v3.5
Command line parameters: --idle_latency

Using buffer size of 2000.000MB
Each iteration took 202.0 core clocks ( 80.8 ns)

```

```

$ sudo /home/testuser/mlc --loaded_latency
Intel(R) Memory Latency Checker - v3.5
Command line parameters: --loaded_latency

Using buffer size of 100.000MB/thread for reads and an additional 100.000MB/thread for writes

Measuring Loaded Latencies for the system
Using all the threads from each core if Hyper-threading is enabled
Using Read-only traffic type
Inject Latency Bandwidth
Delay (ns) MB/sec
=====
00000 282.66 215712.8
00002 282.14 215757.4
00008 280.21 215868.1
00015 279.20 216313.2
00050 275.25 216643.0
00100 227.05 215075.0
00200 121.92 160242.9
00300 101.21 111587.4
00400 95.48 85019.7

```

(continues on next page)

(continued from previous page)

00500	94.46	68717.3
00700	92.27	49742.2
01000	91.03	35264.8
01300	90.11	27396.3
01700	89.34	21178.7
02500	90.15	14672.8
03500	89.00	10715.7
05000	82.00	7788.2
09000	81.46	4684.0
20000	81.40	2541.9

## L1/L2/LLC Latency

```
$ sudo /home/testuser/mlc --c2c_latency
Intel(R) Memory Latency Checker - v3.5
Command line parameters: --c2c_latency

Measuring cache-to-cache transfer latency (in ns)...
Local Socket L2->L2 HIT latency    53.7
Local Socket L2->L2 HITM latency   53.7
Remote Socket L2->L2 HITM latency (data address homed in writer socket)
      Reader Numa Node
Writer Numa Node    0      1
                   0      - 113.9
                   1     113.9  -
Remote Socket L2->L2 HITM latency (data address homed in reader socket)
      Reader Numa Node
Writer Numa Node    0      1
                   0      - 177.9
                   1     177.6  -
```

## Spectre and Meltdown Checks

Following section displays the output of a running shell script to tell if system is vulnerable against the several “speculative execution” CVEs that were made public in 2018. Script is available on [Spectre & Meltdown Checker Github](#)<sup>101</sup>.

- CVE-2017-5753 [bounds check bypass] aka ‘Spectre Variant 1’
- CVE-2017-5715 [branch target injection] aka ‘Spectre Variant 2’
- CVE-2017-5754 [rogue data cache load] aka ‘Meltdown’ aka ‘Variant 3’
- CVE-2018-3640 [rogue system register read] aka ‘Variant 3a’
- CVE-2018-3639 [speculative store bypass] aka ‘Variant 4’
- CVE-2018-3615 [L1 terminal fault] aka ‘Foreshadow (SGX)’
- CVE-2018-3620 [L1 terminal fault] aka ‘Foreshadow-NG (OS)’
- CVE-2018-3646 [L1 terminal fault] aka ‘Foreshadow-NG (VMM)’

```
$ sudo ./spectre-meltdown-checker.sh --no-color

Spectre and Meltdown mitigation detection tool v0.40

Checking for vulnerabilities on current system
Kernel is Linux 4.15.0-23-generic #25-Ubuntu SMP Wed May 23 18:02:16 UTC 2018 x86_64
```

(continues on next page)

<sup>101</sup> <https://github.com/speed47/spectre-meltdown-checker>



(continued from previous page)

```

CPU is Intel(R) Xeon(R) Platinum 8180 CPU @ 2.50GHz

Hardware check
* Hardware support (CPU microcode) for mitigation techniques
  * Indirect Branch Restricted Speculation (IBRS)
    * SPEC_CTRL MSR is available: YES
    * CPU indicates IBRS capability: YES (SPEC_CTRL feature bit)
  * Indirect Branch Prediction Barrier (IBPB)
    * PRED_CMD MSR is available: YES
    * CPU indicates IBPB capability: YES (SPEC_CTRL feature bit)
  * Single Thread Indirect Branch Predictors (STIBP)
    * SPEC_CTRL MSR is available: YES
    * CPU indicates STIBP capability: YES (Intel STIBP feature bit)
  * Speculative Store Bypass Disable (SSBD)
    * CPU indicates SSBD capability: NO
  * L1 data cache invalidation
    * FLUSH_CMD MSR is available: NO
    * CPU indicates L1D flush capability: NO
  * Enhanced IBRS (IBRS_ALL)
    * CPU indicates ARCH_CAPABILITIES MSR availability: NO
    * ARCH_CAPABILITIES MSR advertises IBRS_ALL capability: NO
  * CPU explicitly indicates not being vulnerable to Meltdown (RDCL_NO): NO
  * CPU explicitly indicates not being vulnerable to Variant 4 (SSB_NO): NO
  * CPU/Hypervisor indicates L1D flushing is not necessary on this system: NO
  * Hypervisor indicates host CPU might be vulnerable to RSB underflow (RSBA): NO
  * CPU supports Software Guard Extensions (SGX): NO
  * CPU microcode is known to cause stability problems: NO (model 0x55 family 0x6 stepping 0x4_
↳ ucode 0x2000043 cpuid 0x50654)
    * CPU microcode is the latest known available version: NO (latest version is 0x200004d dated 2018/
↳ 05/15 according to builtin MCEExtractor DB v84 - 2018/09/27)
* CPU vulnerability to the speculative execution attack variants
  * Vulnerable to CVE-2017-5753 (Spectre Variant 1, bounds check bypass): YES
  * Vulnerable to CVE-2017-5715 (Spectre Variant 2, branch target injection): YES
  * Vulnerable to CVE-2017-5754 (Variant 3, Meltdown, rogue data cache load): YES
  * Vulnerable to CVE-2018-3640 (Variant 3a, rogue system register read): YES
  * Vulnerable to CVE-2018-3639 (Variant 4, speculative store bypass): YES
  * Vulnerable to CVE-2018-3615 (Foreshadow (SGX), L1 terminal fault): NO
  * Vulnerable to CVE-2018-3620 (Foreshadow-NG (OS), L1 terminal fault): YES
  * Vulnerable to CVE-2018-3646 (Foreshadow-NG (VMM), L1 terminal fault): YES

CVE-2017-5753 aka 'Spectre Variant 1, bounds check bypass'
* Mitigated according to the /sys interface: YES (Mitigation: __user pointer sanitization)
* Kernel has array_index_mask_nospec: YES (1 occurrence(s) found of x86 64 bits array_index_mask_
↳ nospec())
* Kernel has the Red Hat/Ubuntu patch: NO
* Kernel has mask_nospec64 (arm64): NO
> STATUS: NOT VULNERABLE (Mitigation: __user pointer sanitization)

CVE-2017-5715 aka 'Spectre Variant 2, branch target injection'
* Mitigated according to the /sys interface: YES (Mitigation: Full generic retpoline, IBPB, IBRS_FW)
* Mitigation 1
  * Kernel is compiled with IBRS support: YES
    * IBRS enabled and active: YES (for kernel and firmware code)
  * Kernel is compiled with IBPB support: YES
    * IBPB enabled and active: YES
* Mitigation 2
  * Kernel has branch predictor hardening (arm): NO
  * Kernel compiled with retpoline option: YES
    * Kernel compiled with a retpoline-aware compiler: YES (kernel reports full retpoline_
↳ compilation)
  * Kernel supports RSB filling: YES

```

(continues on next page)

(continued from previous page)

```

> STATUS: NOT VULNERABLE (Full retpoline + IBPB are mitigating the vulnerability)

CVE-2017-5754 aka 'Variant 3, Meltdown, rogue data cache load'
* Mitigated according to the /sys interface: YES (Mitigation: PTI)
* Kernel supports Page Table Isolation (PTI): YES
  * PTI enabled and active: YES
  * Reduced performance impact of PTI: YES (CPU supports INVPCID, performance impact of PTI will be_
↳greatly reduced)
* Running as a Xen PV DomU: NO
> STATUS: NOT VULNERABLE (Mitigation: PTI)

CVE-2018-3640 aka 'Variant 3a, rogue system register read'
* CPU microcode mitigates the vulnerability: NO
> STATUS: VULNERABLE (an up-to-date CPU microcode is needed to mitigate this vulnerability)

CVE-2018-3639 aka 'Variant 4, speculative store bypass'
* Mitigated according to the /sys interface: NO (Vulnerable)
* Kernel supports speculation store bypass: YES (found in /proc/self/status)
> STATUS: VULNERABLE (Your CPU doesn't support SSBD)

CVE-2018-3615 aka 'Foreshadow (SGX), L1 terminal fault'
* CPU microcode mitigates the vulnerability: N/A
> STATUS: NOT VULNERABLE (your CPU vendor reported your CPU model as not vulnerable)

CVE-2018-3620 aka 'Foreshadow-NG (OS), L1 terminal fault'
* Kernel supports PTE inversion: NO
* PTE inversion enabled and active: UNKNOWN (sysfs interface not available)
> STATUS: VULNERABLE (Your kernel doesn't support PTE inversion, update it)

CVE-2018-3646 aka 'Foreshadow-NG (VMM), L1 terminal fault'
* This system is a host running an hypervisor: NO
* Mitigation 1 (KVM)
  * EPT is disabled: NO
* Mitigation 2
  * L1D flush is supported by kernel: NO
  * L1D flush enabled: UNKNOWN (can't find or read /sys/devices/system/cpu/vulnerabilities/l1tf)
  * Hardware-backed L1D flush supported: NO (flush will be done in software, this is slower)
  * Hyper-Threading (SMT) is enabled: YES
> STATUS: NOT VULNERABLE (this system is not running an hypervisor)

> SUMMARY: CVE-2017-5753:OK CVE-2017-5715:OK CVE-2017-5754:OK CVE-2018-3640:KO CVE-2018-3639:KO CVE-
↳2018-3615:OK CVE-2018-3620:KO CVE-2018-3646:OK

Need more detailed information about mitigation options? Use --explain
A false sense of security is worse than no security at all, see --disclaimer

```

## 2.10.6 Calibration Data - Denverton

Following sections include sample calibration data measured on Denverton server at Intel SH labs.

And VPP-18.10 2-Node Atom Denverton testing took place at Intel Corporation carefully adhering to FD.io CSIT best practices.

### Linux cmdline

```

$ cat /proc/cmdline
BOOT_IMAGE=/boot/vmlinuz-4.15.0-36-generic root=UUID=d3cfff0-1e77-423a-a53a-a117199b6025 ro intel_
↳iommu=on iommu=pt isolcpus=1-11 nohz_full=1-11 rcu_nocbs=1-11 default_hugepagesz=1G hugepagesz=1G_
↳hugepages=8 intel_pstate=disable nmi_watchdog=0 numa_balancing=disable tsc=reliable nosoftlockup_
↳quiet splash vt.handoff=7

```

(continues on next page)

(continued from previous page)

**Linux uname**

```
$ uname -a
Linux 4.15.0-36-generic #39~16.04.1-Ubuntu SMP Tue Sep 25 08:59:23 UTC 2018 x86_64 x86_64 x86_64
↳ GNU/Linux
```

**System-level Core Jitter**

```
$ sudo taskset -c 2 /home/testuser/pma_tools/jitter/jitter -c 2 -i 20
Linux Jitter testing program version 1.9
Iterations=20
The program will execute a dummy function 80000 times
Display is updated every 20000 displayUpdate intervals
Thread affinity will be set to core_id:2
Timings are in CPU Core cycles
Inst_Min:   Minimum Execution time during the display update interval(default is ~1 second)
Inst_Max:   Maximum Execution time during the display update interval(default is ~1 second)
Inst_jitter: Jitter in the Execution time during the display update interval. This is the value of
↳ interest
last_Exec:  The Execution time of last iteration just before the display update
Abs_Min:   Absolute Minimum Execution time since the program started or statistics were reset
Abs_Max:   Absolute Maximum Execution time since the program started or statistics were reset
tmp:       Cumulative value calculated by the dummy function
Interval:  Time interval between the display updates in Core Cycles
Sample No: Sample number
```

Inst_Min	Inst_Max	Inst_jitter	last_Exec	Abs_min	Abs_max	tmp	Interval	
↳ Sample No								
177530	196100	18570	177530	177530	196100	4156751872	3556820054	↳
↳ 1								
177530	200784	23254	177530	177530	200784	321060864	3556897644	↳
↳ 2								
177530	196346	18816	177530	177530	200784	780337152	3556918674	↳
↳ 3								
177530	195962	18432	177530	177530	200784	1239613440	3556847928	↳
↳ 4								
177530	195960	18430	177530	177530	200784	1698889728	3556860214	↳
↳ 5								
177530	198824	21294	177530	177530	200784	2158166016	3556854934	↳
↳ 6								
177530	198522	20992	177530	177530	200784	2617442304	3556862410	↳
↳ 7								
177530	196362	18832	177530	177530	200784	3076718592	3556851636	↳
↳ 8								
177530	199114	21584	177530	177530	200784	3535994880	3556870846	↳
↳ 9								
177530	197194	19664	177530	177530	200784	3995271168	3556933584	↳
↳ 10								
177530	198272	20742	177530	177530	200784	159580160	3556869044	↳
↳ 11								
177530	197586	20056	177530	177530	200784	618856448	3556903482	↳
↳ 12								
177530	196072	18542	177530	177530	200784	1078132736	3556825540	↳
↳ 13								
177530	196354	18824	177530	177530	200784	1537409024	3556881664	↳
↳ 14								

(continues on next page)

(continued from previous page)

	177530	195906	18376	177530	177530	200784	1996685312	3556839924	└
↔15									
	177530	199066	21536	177530	177530	200784	2455961600	3556860220	└
↔16									
	177530	196968	19438	177530	177530	200784	2915237888	3556871890	└
↔17									
	177530	195896	18366	177530	177530	200784	3374514176	3556855338	└
↔18									
	177530	196020	18490	177530	177530	200784	3833790464	3556839820	└
↔19									
	177530	196030	18500	177530	177530	200784	4293066752	3556889196	└
↔20									

## Memory Bandwidth

```
$ sudo /home/testuser/mlc --bandwidth_matrix
Intel(R) Memory Latency Checker - v3.5
Command line parameters: --bandwidth_matrix

Using buffer size of 100.000MB/thread for reads and an additional 100.000MB/thread for writes
Measuring Memory Bandwidths between nodes within system
Bandwidths are in MB/sec (1 MB/sec = 1,000,000 Bytes/sec)
Using all the threads from each core if Hyper-threading is enabled
Using Read-only traffic type
Memory node
Socket      0
0 28157.2
```

```
$ sudo /home/testuser/mlc --peak_injection_bandwidth
Intel(R) Memory Latency Checker - v3.5
Command line parameters: --peak_injection_bandwidth

Using buffer size of 100.000MB/thread for reads and an additional 100.000MB/thread for writes

Measuring Peak Injection Memory Bandwidths for the system
Bandwidths are in MB/sec (1 MB/sec = 1,000,000 Bytes/sec)
Using all the threads from each core if Hyper-threading is enabled
Using traffic with the following read-write ratios
ALL Reads      :      28150.0
3:1 Reads-Writes :      27425.0
2:1 Reads-Writes :      27565.4
1:1 Reads-Writes :      27489.3
Stream-triad like:      26878.2
```

```
$ sudo /home/testuser/mlc --max_bandwidth
Intel(R) Memory Latency Checker - v3.5
Command line parameters: --max_bandwidth

Using buffer size of 100.000MB/thread for reads and an additional 100.000MB/thread for writes

Measuring Maximum Memory Bandwidths for the system
Will take several minutes to complete as multiple injection rates will be tried to get the best
↔bandwidth
Bandwidths are in MB/sec (1 MB/sec = 1,000,000 Bytes/sec)
Using all the threads from each core if Hyper-threading is enabled
Using traffic with the following read-write ratios
ALL Reads      :      30032.40
3:1 Reads-Writes :      27450.88
```

(continues on next page)

(continued from previous page)

```

2:1 Reads-Writes :    27567.46
1:1 Reads-Writes :    27501.90
Stream-triad like:    27124.82

```

## Memory Latency

```

$ sudo /home/testuser/mlc --latency_matrix
Intel(R) Memory Latency Checker - v3.5
Command line parameters: --latency_matrix

```

```

Using buffer size of 2000.000MB
Intel(R) Memory Latency Checker - v3.5
Measuring idle latencies (in ns)...
      Memory node
Socket      0
           0    93.1

```

```

$ sudo /home/testuser/mlc --idle_latency
Intel(R) Memory Latency Checker - v3.5
Command line parameters: --idle_latency

Using buffer size of 200.000MB
Each iteration took 186.7 core clocks ( 93.4  ns)

```

```

$ sudo /home/testuser/mlc --loaded_latency
Intel(R) Memory Latency Checker - v3.5
Command line parameters: --loaded_latency

Using buffer size of 100.000MB/thread for reads and an additional 100.000MB/thread for writes

Measuring Loaded Latencies for the system
Using all the threads from each core if Hyper-threading is enabled
Using Read-only traffic type
Inject  Latency Bandwidth
Delay  (ns)  MB/sec
=====
00000  135.35  27186.0
00002  135.47  27176.9
00008  134.97  27063.3
00015  134.41  26825.6
00050  139.83  28419.1
00100  124.28  22616.4
00200  109.40  14139.8
00300  104.56  10275.1
00400  102.02   8120.0
00500  100.38   6751.4
00700   98.30   5124.9
01000   96.56   3852.7
01300   95.65   3149.0
01700   95.06   2585.4
02500   94.43   1988.8
03500   94.16   1621.1
05000   93.95   1343.1
09000   93.65   1052.6
20000   93.43    851.7

```

## L1/L2/LLC Latency

```
$ sudo /home/testuser/mlc --c2c_latency
Intel(R) Memory Latency Checker - v3.5
Command line parameters: --c2c_latency

Measuring cache-to-cache transfer latency (in ns)...
Local Socket L2->L2 HIT latency      8.8
Local Socket L2->L2 HITM latency     8.8
```

## Spectre and Meltdown Checks

Following section displays the output of a running shell script to tell if system is vulnerable against the several “speculative execution” CVEs that were made public in 2018. Script is available on [Spectre & Meltdown Checker Github](#)<sup>102</sup>.

- CVE-2017-5753 [bounds check bypass] aka ‘Spectre Variant 1’
- CVE-2017-5715 [branch target injection] aka ‘Spectre Variant 2’
- CVE-2017-5754 [rogue data cache load] aka ‘Meltdown’ aka ‘Variant 3’
- CVE-2018-3640 [rogue system register read] aka ‘Variant 3a’
- CVE-2018-3639 [speculative store bypass] aka ‘Variant 4’
- CVE-2018-3615 [L1 terminal fault] aka ‘Foreshadow (SGX)’
- CVE-2018-3620 [L1 terminal fault] aka ‘Foreshadow-NG (OS)’
- CVE-2018-3646 [L1 terminal fault] aka ‘Foreshadow-NG (VMM)’

```
$ sudo ./spectre-meltdown-checker.sh --no-color

Spectre and Meltdown mitigation detection tool v0.40

Checking for vulnerabilities on current system
Kernel is Linux 4.15.0-36-generic #39~16.04.1-Ubuntu SMP Tue Sep 25 08:59:23 UTC 2018 x86_64
CPU is Intel(R) Atom(TM) CPU C3858 @ 2.00GHz

Hardware check
* Hardware support (CPU microcode) for mitigation techniques
  * Indirect Branch Restricted Speculation (IBRS)
    * SPEC_CTRL MSR is available: YES
    * CPU indicates IBRS capability: YES (SPEC_CTRL feature bit)
  * Indirect Branch Prediction Barrier (IBPB)
    * PRED_CMD MSR is available: YES
    * CPU indicates IBPB capability: YES (SPEC_CTRL feature bit)
  * Single Thread Indirect Branch Predictors (STIBP)
    * SPEC_CTRL MSR is available: YES
    * CPU indicates STIBP capability: YES (Intel STIBP feature bit)
  * Speculative Store Bypass Disable (SSBD)
    * CPU indicates SSBD capability: YES (Intel SSBD)
  * L1 data cache invalidation
    * FLUSH_CMD MSR is available: NO
    * CPU indicates L1D flush capability: NO
  * Enhanced IBRS (IBRS_ALL)
    * CPU indicates ARCH_CAPABILITIES MSR availability: YES
    * ARCH_CAPABILITIES MSR advertises IBRS_ALL capability: NO
  * CPU explicitly indicates not being vulnerable to Meltdown (RDCL_NO): YES
  * CPU explicitly indicates not being vulnerable to Variant 4 (SSB_NO): NO
```

(continues on next page)

<sup>102</sup> <https://github.com/speed47/spectre-meltdown-checker>

(continued from previous page)

```

* CPU/Hypervisor indicates L1D flushing is not necessary on this system: YES
* Hypervisor indicates host CPU might be vulnerable to RSB underflow (RSBA): NO
* CPU supports Software Guard Extensions (SGX): NO
* CPU microcode is known to cause stability problems: NO (model 0x5f family 0x6 stepping 0x1_
↳ ucode 0x24 cpuid 0x506f1)
* CPU microcode is the latest known available version: YES (latest version is 0x24 dated 2018/05/
↳ 11 according to builtin MCEExtractor DB v84 - 2018/09/27)
* CPU vulnerability to the speculative execution attack variants
  * Vulnerable to CVE-2017-5753 (Spectre Variant 1, bounds check bypass): YES
  * Vulnerable to CVE-2017-5715 (Spectre Variant 2, branch target injection): YES
  * Vulnerable to CVE-2017-5754 (Variant 3, Meltdown, rogue data cache load): NO
  * Vulnerable to CVE-2018-3640 (Variant 3a, rogue system register read): YES
  * Vulnerable to CVE-2018-3639 (Variant 4, speculative store bypass): YES
  * Vulnerable to CVE-2018-3615 (Foreshadow (SGX), L1 terminal fault): NO
  * Vulnerable to CVE-2018-3620 (Foreshadow-NG (OS), L1 terminal fault): YES
  * Vulnerable to CVE-2018-3646 (Foreshadow-NG (VMM), L1 terminal fault): YES

CVE-2017-5753 aka 'Spectre Variant 1, bounds check bypass'
* Mitigated according to the /sys interface: YES (Mitigation: __user pointer sanitization)
* Kernel has array_index_mask_nospec: YES (1 occurrence(s) found of x86 64 bits array_index_mask_
↳ nospec())
* Kernel has the Red Hat/Ubuntu patch: NO
* Kernel has mask_nospec64 (arm64): NO
> STATUS: NOT VULNERABLE (Mitigation: __user pointer sanitization)

CVE-2017-5715 aka 'Spectre Variant 2, branch target injection'
* Mitigated according to the /sys interface: YES (Mitigation: Full generic retpoline, IBPB, IBRS_FW)
* Mitigation 1
  * Kernel is compiled with IBRS support: YES
    * IBRS enabled and active: YES (for kernel and firmware code)
  * Kernel is compiled with IBPB support: YES
    * IBPB enabled and active: YES
* Mitigation 2
  * Kernel has branch predictor hardening (arm): NO
  * Kernel compiled with retpoline option: YES
    * Kernel compiled with a retpoline-aware compiler: YES (kernel reports full retpoline_
↳ compilation)
> STATUS: NOT VULNERABLE (Full retpoline + IBPB are mitigating the vulnerability)

CVE-2017-5754 aka 'Variant 3, Meltdown, rogue data cache load'
* Mitigated according to the /sys interface: YES (Not affected)
* Kernel supports Page Table Isolation (PTI): YES
  * PTI enabled and active: NO
  * Reduced performance impact of PTI: NO (PCID/INVCID not supported, performance impact of PTI_
↳ will be significant)
* Running as a Xen PV DomU: NO
> STATUS: NOT VULNERABLE (your CPU vendor reported your CPU model as not vulnerable)

CVE-2018-3640 aka 'Variant 3a, rogue system register read'
* CPU microcode mitigates the vulnerability: YES
> STATUS: NOT VULNERABLE (your CPU microcode mitigates the vulnerability)

CVE-2018-3639 aka 'Variant 4, speculative store bypass'
* Mitigated according to the /sys interface: YES (Mitigation: Speculative Store Bypass disabled via_
↳ prctl and seccomp)
* Kernel supports speculation store bypass: YES (found in /proc/self/status)
> STATUS: NOT VULNERABLE (Mitigation: Speculative Store Bypass disabled via prctl and seccomp)

CVE-2018-3615 aka 'Foreshadow (SGX), L1 terminal fault'
* CPU microcode mitigates the vulnerability: N/A
> STATUS: NOT VULNERABLE (your CPU vendor reported your CPU model as not vulnerable)

```

(continues on next page)

(continued from previous page)

```

CVE-2018-3620 aka 'Foreshadow-NG (OS), L1 terminal fault'
* Mitigated according to the /sys interface: YES (Not affected)
* Kernel supports PTE inversion: YES (found in kernel image)
* PTE inversion enabled and active: NO
> STATUS: NOT VULNERABLE (Not affected)

CVE-2018-3646 aka 'Foreshadow-NG (VMM), L1 terminal fault'
* Information from the /sys interface:
* This system is a host running an hypervisor: NO
* Mitigation 1 (KVM)
  * EPT is disabled: NO
* Mitigation 2
  * L1D flush is supported by kernel: YES (found flush_l1d in kernel image)
  * L1D flush enabled: UNKNOWN (unrecognized mode)
  * Hardware-backed L1D flush supported: NO (flush will be done in software, this is slower)
  * Hyper-Threading (SMT) is enabled: NO
> STATUS: NOT VULNERABLE (this system is not running an hypervisor)

> SUMMARY: CVE-2017-5753:OK CVE-2017-5715:OK CVE-2017-5754:OK CVE-2018-3640:OK CVE-2018-3639:OK CVE-
→2018-3615:OK CVE-2018-3620:OK CVE-2018-3646:OK

Need more detailed information about mitigation options? Use --explain
A false sense of security is worse than no security at all, see --disclaimer

```

## 2.10.7 SUT Settings - Linux

System provisioning is done by combination of PXE boot unattended install and [Ansible](#)<sup>103</sup> described in [CSIT Testbed Setup](#)<sup>104</sup>.

Below a subset of the running configuration:

### 1. Xeon Haswell - Ubuntu 18.04.1 LTS

```

$ lsb_release -a
No LSB modules are available.
Distributor ID: Ubuntu
Description:    Ubuntu 18.04.1 LTS
Release:        18.04
Codename:       bionic

```

### 2. Xeon Skylake - Ubuntu 18.04 LTS

```

$ lsb_release -a
No LSB modules are available.
Distributor ID: Ubuntu
Description:    Ubuntu 18.04 LTS
Release:        18.04
Codename:       bionic

```

## Linux Boot Parameters

- `isolcpus=<cpu number>--<cpu number>` used for all cpu cores apart from first core of each socket used for running VPP worker threads and Qemu/LXC processes <https://www.kernel.org/doc/Documentation/admin-guide/kernel-parameters.txt>

<sup>103</sup> <https://www.ansible.com>

<sup>104</sup> <https://git.fd.io/csit/tree/resources/tools/testbed-setup/README.md?h=rls1901>



- **intel\_pstate=disable** - [X86] Do not enable intel\_pstate as the default scaling driver for the supported processors. Intel P-State driver decide what P-state (CPU core power state) to use based on requesting policy from the cpufreq core. [X86 - Either 32-bit or 64-bit x86] <https://www.kernel.org/doc/Documentation/cpu-freq/intel-pstate.txt>
- **nohz\_full=<cpu number>-<cpu number>** - [KNL,BOOT] In kernels built with CONFIG\_NO\_HZ\_FULL=y, set the specified list of CPUs whose tick will be stopped whenever possible. The boot CPU will be forced outside the range to maintain the timekeeping. The CPUs in this range must also be included in the rcu\_nocbs= set. Specifies the adaptive-ticks CPU cores, causing kernel to avoid sending scheduling-clock interrupts to listed cores as long as they have a single runnable task. [KNL - Is a kernel start-up parameter, SMP - The kernel is an SMP kernel]. [https://www.kernel.org/doc/Documentation/timers/NO\\_HZ.txt](https://www.kernel.org/doc/Documentation/timers/NO_HZ.txt)
- **rcu\_nocbs** - [KNL] In kernels built with CONFIG\_RCU\_NOCB\_CPU=y, set the specified list of CPUs to be no-callback CPUs, that never queue RCU callbacks (read-copy update). <https://www.kernel.org/doc/Documentation/admin-guide/kernel-parameters.txt>
- **numa\_balancing=disable** - [KNL,X86] Disable automatic NUMA balancing.
- **intel\_iommu=enable** - [DMAR] Enable Intel IOMMU driver (DMAR) option.
- **iommu=on, iommu=pt** - [x86, IA-64] Disable IOMMU bypass, using IOMMU for PCI devices.
- **nmi\_watchdog=0** - [KNL,BUGS=X86] Debugging features for SMP kernels. Turn hardlockup detector in nmi\_watchdog off.
- **nosoftlockup** - [KNL] Disable the soft-lockup detector.
- **tsc=reliable** - Disable clocksource stability checks for TSC. [x86] reliable: mark tsc clocksource as reliable, this disables clocksource verification at runtime, as well as the stability checks done at bootup. Used to enable high-resolution timer mode on older hardware, and in virtualized environment.
- **hpet=disable** - [X86-32,HPET] Disable HPET and use PIT instead.

## Applied Boot Cmdline

### 1. Xeon Haswell - Ubuntu 18.04.1 LTS

```
$ cat /proc/cmdline
BOOT_IMAGE=/vmlinuz-4.15.0-36-generic root=UUID=5d2ecc97-245b-4e94-b0ae-c3548567de19 ro isolcpus=1-
↪17,19-35 nohz_full=1-17,19-35 rcu_nocbs=1-17,19-35 numa_balancing=disable intel_pstate=disable_
↪intel_iommu=on iommu=pt nmi_watchdog=0 audit=0 nosoftlockup processor.max_cstate=1 intel_idle.max_
↪cstate=1 hpet=disable tsc=reliable mce=off console=tty0 console=ttyS0,115200n8
```

### 2. Xeon Skylake - Ubuntu 18.04 LTS

```
$ cat /proc/cmdline
BOOT_IMAGE=/vmlinuz-4.15.0-23-generic root=UUID=3fa246fd-1b80-4361-bb90-f339a6bbbed51 ro isolcpus=1-
↪27,29-55,57-83,85-111 nohz_full=1-27,29-55,57-83,85-111 rcu_nocbs=1-27,29-55,57-83,85-111 numa_
↪balancing=disable intel_pstate=disable intel_iommu=on iommu=pt nmi_watchdog=0 audit=0_
↪nosoftlockup processor.max_cstate=1 intel_idle.max_cstate=1 hpet=disable tsc=reliable mce=off_
↪console=tty0 console=ttyS0,115200n8
```

## Linux CFS Tunings

Linux CFS scheduler tunings are applied to all QEMU vCPU worker threads (the ones handling testpmd PMD threads) and VPP data plane worker threads. List of VPP data plane threads can be obtained by running:

```
$ for psid in $(pgrep vpp)
$ do
$   for tid in $(ps -Lo tid --pid $psid | grep -v TID)
$     do
$       echo $tid
$     done
$ done
```

Or:

```
$ cat /proc/`pidof vpp`/task/*/stat | awk '{print $1" "$2" "$39}'
```

CFS round-robin scheduling with highest priority is applied using:

```
$ for psid in $(pgrep vpp)
$ do
$   for tid in $(ps -Lo tid --pid $psid | grep -v TID)
$     do
$       chrt -r -p 1 $tid
$     done
$ done
```

More information about Linux CFS can be found in [Sched manual pages](#)<sup>105</sup>.

### Host Writeback Affinity

Writebacks are pinned to core 0. The same configuration is applied in host Linux and guest VM.

```
$ echo 1 | sudo tee /sys/bus/workqueue/devices/writeback/cpumask
```

## 2.10.8 DUT Settings - VPP

### VPP Version

VPP-19.01 release

### VPP Compile Parameters

FD.io VPP compile job<sup>106</sup>

### VPP Install Parameters

```
$ dpkg -i --force-all vpp*
```

### VPP Startup Configuration

VPP startup configuration vary per test case, with different settings for `$$CORELIST_WORKERS`, `$$NUM_RX_QUEUES`, `$$UIO_DRIVER`, `$$NUM-MBUFS` and `$$NO_MULTI_SEG` parameter. Default template is provided below:

<sup>105</sup> <http://man7.org/linux/man-pages/man7/sched.7.html>

<sup>106</sup> <https://jenkins.fd.io/view/vpp/job/vpp-merge-1901-ubuntu1604/>

```
ip
{
  heap-size 4G
}
statseg
{
  size 4G
}
unix
{
  cli-listen /run/vpp/cli.sock
  log /tmp/vpe.log
  nodaemon
}
ip6
{
  heap-size 4G
  hash-buckets 2000000
}
heapsize 4G
plugins
{
  plugin default
  {
    disable
  }
  plugin dpdk_plugin.so
  {
    enable
  }
}
cpu
{
  corelist-workers $$CORELIST_WORKERS
  main-core 1
}
dpdk
{
  num-mbufs $$NUM-MBUFS
  uiio-driver $$UIO_DRIVER
  $$NO_MULTI_SEG
  log-level debug
  dev default
  {
    num-rx-queues $$NUM_RX_QUEUES
  }
  socket-mem 1024,1024
  no-tx-checksum-offload
  dev $$DEV_1
  dev $$DEV_2
}
```

Description of VPP startup settings used in CSIT is provided in *Test Methodology* (page 11).

## 2.10.9 TG Settings - TRex

### TRex Version

TRex v2.35

## DPDK Version

DPDK v17.11

## TG Build Script Used

TRex intallation<sup>107</sup>

## TG Startup Configuration

```
$ cat /etc/trex_cfg.yaml
- port_limit      : 2
  version        : 2
  interfaces     : ["0000:0d:00.0", "0000:0d:00.1"]
  port_info      :
    - dest_mac   : [0x3c,0xfd,0xfe,0x9c,0xee,0xf5]
      src_mac    : [0x3c,0xfd,0xfe,0x9c,0xee,0xf4]
    - dest_mac   : [0x3c,0xfd,0xfe,0x9c,0xee,0xf4]
      src_mac    : [0x3c,0xfd,0xfe,0x9c,0xee,0xf5]
```

## TG Startup Command

```
$ sh -c 'cd <t-rex-install-dir>/scripts/ && sudo nohup ./t-rex-64 -i -c 7 --iom 0 > /tmp/trex.log 2>
↵&1 &' > /dev/null
```

## TG API Driver

TRex driver<sup>108</sup>

<sup>107</sup> [https://git.fd.io/csit/tree/resources/tools/trex/trex\\_installer.sh?h=rls1901](https://git.fd.io/csit/tree/resources/tools/trex/trex_installer.sh?h=rls1901)

<sup>108</sup> [https://git.fd.io/csit/tree/resources/tools/trex/trex\\_stateless\\_profile.py?h=rls1901](https://git.fd.io/csit/tree/resources/tools/trex/trex_stateless_profile.py?h=rls1901)

## 2.11 Documentation

### 2.11.1 Container Orchestration in CSIT

#### Overview

#### Linux Containers

Linux Containers is an OS-level virtualization method for running multiple isolated Linux systems (containers) on a compute host using a single Linux kernel. Containers rely on Linux kernel cgroups functionality for controlling usage of shared system resources (i.e. CPU, memory, block I/O, network) and for namespace isolation. The latter enables complete isolation of applications' view of operating environment, including process trees, networking, user IDs and mounted file systems.

LXC (Linux Containers) combine kernel's cgroups and support for isolated namespaces to provide an isolated environment for applications. Docker does use LXC as one of its execution drivers, enabling image management and providing deployment services. More information in [\[lxc\]](#) (page 907), [\[lxcnamespace\]](#) (page 907) and [\[stgraber\]](#) (page 907).

Linux containers can be of two kinds: privileged containers and unprivileged containers.

#### Unprivileged Containers

Running unprivileged containers is the safest way to run containers in a production environment. From LXC 1.0 one can start a full system container entirely as a user, allowing to map a range of UIDs on the host into a namespace inside of which a user with UID 0 can exist again. In other words an unprivileged container does mask the userid from the host, making it impossible to gain a root access on the host even if a user gets root in a container. With unprivileged containers, non-root users can create containers and will appear in the container as the root, but will appear as userid <non-zero> on the host. Unprivileged containers are also better suited to supporting multi-tenancy operating environments. More information in [\[lxcsecurity\]](#) (page 907) and [\[stgraber\]](#) (page 907).

#### Privileged Containers

Privileged containers do not mask UIDs, and container UID 0 is mapped to the host UID 0. Security and isolation is controlled by a good configuration of cgroup access, extensive AppArmor profile preventing the known attacks as well as container capabilities and SELinux. Here a list of applicable security control mechanisms:

- Capabilities - keep (whitelist) or drop (blacklist) Linux capabilities, [\[capabilities\]](#) (page 907).
- Control groups - cgroups, resource bean counting, resource quotas, access restrictions, [\[cgroup1\]](#) (page 907), [\[cgroup2\]](#) (page 907).
- AppArmor - apparmor profiles aim to prevent any of the known ways of escaping a container or cause harm to the host, [\[apparmor\]](#) (page 907).
- SELinux - Security Enhanced Linux is a Linux kernel security module that provides similar function to AppArmor, supporting access control security policies including United States Department of Defense-style mandatory access controls. Mandatory access controls allow an administrator of a system to define how applications and users can access different resources such as files, devices, networks and inter- process communication, [\[selinux\]](#) (page 907).
- Seccomp - secure computing mode, enables filtering of system calls, [\[seccomp\]](#) (page 907).

More information in [\[lxcsecurity\]](#) (page 907) and [\[lxcsecfeatures\]](#) (page 907).

#### Linux Containers in CSIT

CSIT is using Privileged Containers as the `sysfs` is mounted with RW access. `sysfs` is required to be mounted as RW due to VPP accessing `/sys/bus/pci/drivers/uisv_pci_generic/unbind`. This is not the case of unprivileged containers where `sysfs` is mounted as read-only.

### Orchestrating Container Lifecycle Events

Following Linux container lifecycle events need to be addressed by an orchestration system:

1. Acquire - acquiring/downloading existing container images via `docker pull` or `lxc-create -t download`.
2. Build - building a container image from scratch or another container image via `docker build <dockerfile/composefile>` or customizing LXC templates in [GitHub](#)<sup>109</sup>.
3. (Re-)Create - creating a running instance of a container application from anew, or re-creating one that failed. A.k.a. (re-)deploy via `docker run` or `lxc-start`
4. Execute - execute system operations within the container by attaching to running container. This is done by `lxc-attach` or `docker exec`
5. Distribute - distributing pre-built container images to the compute nodes. Currently not implemented in CSIT.

### Container Orchestration Systems Used in CSIT

Current CSIT testing framework integrates following Linux container orchestration mechanisms:

- LXC/Docker for complete VPP container lifecycle control.
- Combination of Kubernetes (container orchestration), Docker (container images) and Ligato (container networking).

### LXC

LXC is the well-known and heavily tested low-level Linux container runtime [[lxcsource](#)] (page 907), that provides a userspace interface for the Linux kernel containment features. With a powerful API and simple tools, LXC enables Linux users to easily create and manage system or application containers. LXC uses following kernel features to contain processes:

- Kernel namespaces: ipc, uts, mount, pid, network and user.
- AppArmor and SELinux security profiles.
- Seccomp policies.
- Chroot.
- Cgroups.

CSIT uses LXC runtime and LXC usertools to test VPP data plane performance in a range of virtual networking topologies.

#### Known Issues

- Current CSIT restriction: only single instance of `lxc` runtime due to the `cgroup` policies used in CSIT. There is plan to add the capability into code to create `cgroups` per container instance to address this issue. This sort of functionality is better supported in LXC 2.1 but can be done in current version as well.
- CSIT code is currently using `cgroup` to control the range of CPU cores the LXC container runs on. VPP thread pinning is defined in `vpp startup.conf`.

<sup>109</sup> <https://github.com/lxc/lxc/tree/master/templates>

## Docker

Docker builds on top of Linux kernel containment features, and offers a high-level tool for wrapping the processes, maintaining and executing them in containers [docker] (page 907). Currently it using *runc* a CLI tool for spawning and running containers according to the [OCI specification](#)<sup>110</sup>

A Docker container image is a lightweight, stand-alone, executable package of a piece of software that includes everything needed to run it: code, runtime, system tools, system libraries, settings.

CSIT uses Docker to manage the maintenance and execution of containerized applications used in CSIT performance tests.

- Data plane thread pinning to CPU cores - Docker CLI and/or Docker configuration file controls the range of CPU cores the Docker image must run on. VPP thread pinning defined vpp startup.conf.

## Kubernetes

Kubernetes [k8sdoc] (page 907), or K8s, is a production-grade container orchestration platform for automating the deployment, scaling and operating application containers. Kubernetes groups containers that make up an application into logical units, pods, for easy management and discovery. K8s pod definitions including compute resource allocation is provided in .yaml files.

CSIT uses K8s and its infrastructure components like etcd to control all phases of container based virtualized network topologies.

## Ligato

Ligato [ligato] (page 907) is an open-source project developing a set of cloud-native tools for orchestrating container networking. Ligato integrates with FD.io VPP using goVPP [govpp] (page 907) and vpp-agent [vppagent] (page 907).

### Known Issues

- Currently using a separate LF Jenkins job for building csit-centric prod\_vpp\_agent docker images vs. dockerhub/ligato ones.

## Implementation

CSIT container orchestration is implemented in CSIT Level-1 keyword Python libraries following the Builder design pattern. Builder design pattern separates the construction of a complex object from its representation, so that the same construction process can create different representations e.g. LXC, Docker, other.

CSIT Robot Framework keywords are then responsible for higher level lifecycle control of of the named container groups. One can have multiple named groups, with 1..N containers in a group performing different role/functionality e.g. NFs, Switch, Kafka bus, ETCD datastore, etc. ContainerManager class acts as a Director and uses ContainerEngine class that encapsulate container control.

Current CSIT implementation is illustrated using UML Class diagram:

1. Acquire
2. Build
3. (Re-)Create
4. Execute

---

<sup>110</sup> <https://www.opencontainers.org/>

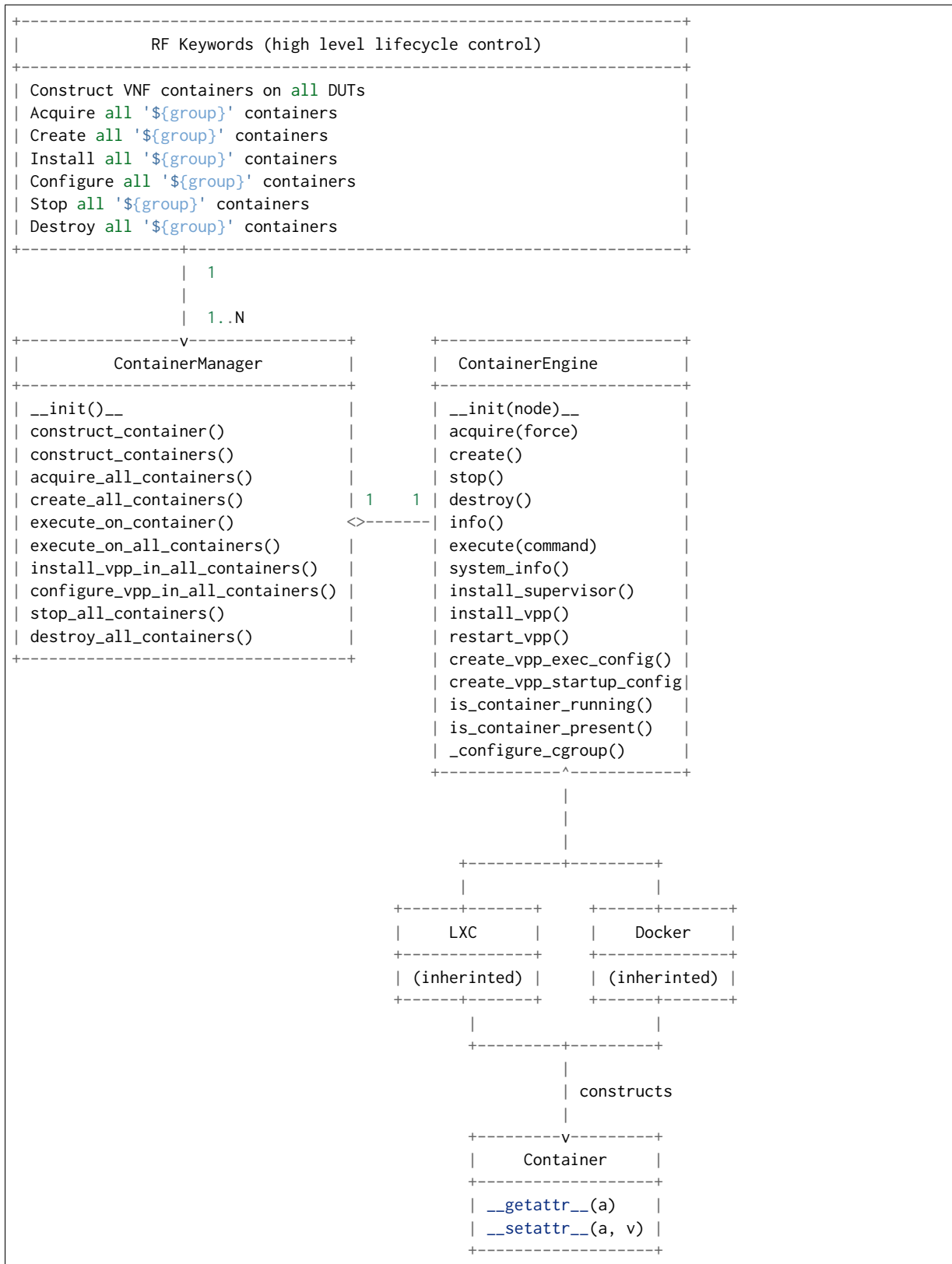

Sequential diagram that illustrates the creation of a single container.

Legend:  
 e = engine [Docker|LXC]  
 .. = kwargs (variable number of keyword argument)

(continues on next page)



(continued from previous page)

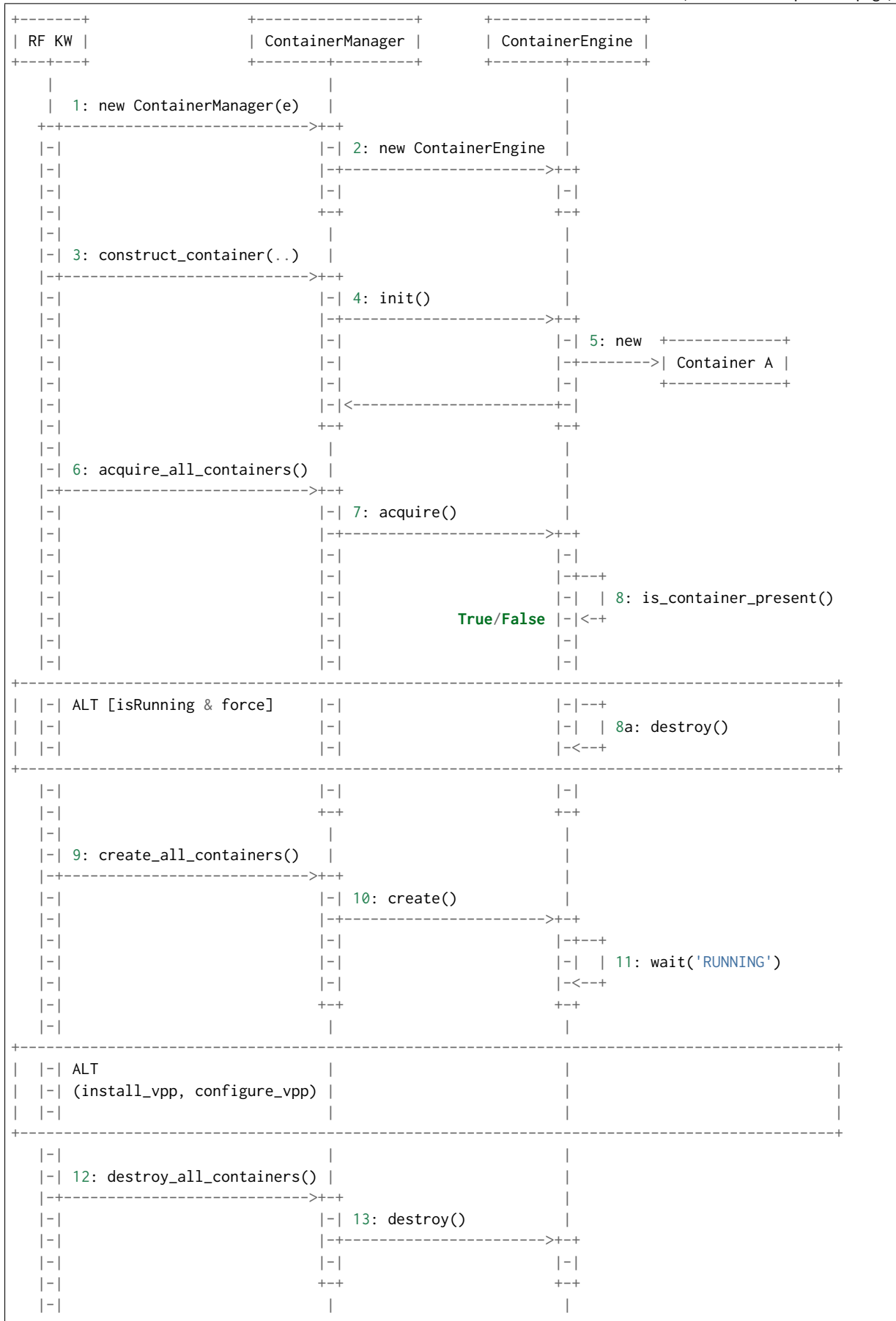

(continues on next page)

(continued from previous page)

+++		
+	+	+

## Container Data Structure

Container is represented in Python L1 library as a separate Class with instance variables and no methods except overridden `__getattr__` and `__setattr__`. Instance variables are assigned to container dynamically during the `construct_container(**kwargs)` call and are passed down from the RF keyword.

Usage example:

```
| Construct VNF containers on all DUTs
| | [Arguments] | ${technology} | ${image} | ${cpu_count}=${1} | ${count}=${1}
| | ...
| | ${group}= | Set Variable | VNF
| | ${skip_cpus}= | Evaluate | ${vpp_cpus}+${system_cpus}
| | Import Library | resources.libraries.python.ContainerUtils.ContainerManager
| | ... | engine=${container_engine} | WITH NAME | ${group}
| | ${duts}= | Get Matches | ${nodes} | DUT*
| | :FOR | ${dut} | IN | @${duts}
| | | ${env}= | Create List | DEBIAN_FRONTEND=noninteractive
| | | ${mnt}= | Create List | /tmp:/mnt/host | /dev:/dev
| | | ${cpu_node}= | Get interfaces numa node | ${nodes['${dut}']}
| | | ... | ${dut1_if1} | ${dut1_if2}
| | | Run Keyword | ${group}.Construct containers
| | | ... | name=${dut}_${group} | node=${nodes['${dut}']} | mnt=${mnt}
| | | ... | image=${container_image} | cpu_count=${container_cpus}
| | | ... | cpu_skip=${skip_cpus} | cpuset_mems=${cpu_node}
| | | ... | cpu_shared=${False} | env=${env} | count=${container_count}
| | | ... | install_dkms=${container_install_dkms}
| | Append To List | ${container_groups} | ${group}
```

Mandatory parameters to create standalone container are: node, name, image [*imagevar*] (page 908), cpu\_count, cpu\_skip, cpuset\_mems, cpu\_shared.

There is no parameters check functionality. Passing required arguments is in coder responsibility. All the above parameters are required to calculate the correct cpu placement. See documentation for the full reference.

## Kubernetes

Kubernetes is implemented as separate library `KubernetesUtils.py`, with a class with the same name. This utility provides an API for L2 Robot Keywords to control `kubect1` installed on each of DUTs. One time initialization script, `resources/libraries/bash/k8s_setup.sh` does reset/init `kubect1`, applies Calico v2.6.3 and initializes the `csit` namespace. `CSIT` namespace is required to not to interfere with existing setups and it further simplifies `apply/get/delete Pod/ConfigMap` operations on SUTs.

Kubernetes utility is based on YAML templates to avoid crafting the huge YAML configuration files, what would lower the readability of code and requires complicated algorithms. The templates can be found in `resources/templates/kubernetes` and can be leveraged in the future for other separate tasks.

Two types of YAML templates are defined:

- Static - do not change between deployments, that is infrastructure containers like Kafka, Calico, ETCD.
- Dynamic - per test suite/case topology YAML files e.g. `SFC_controller`, `VNF`, `VSWITCH`.

Making own python wrapper library of kubect1 instead of using the official Python package allows to control and deploy environment over the SSH library without the need of using isolated driver running on each of DUTs.

## Ligato

Ligato integration does require to compile the vpp-agent tool and build the bundled Docker image. Compilation of vpp-agent depends on specific VPP. In ligato/vpp-agent repository there are well prepared scripts for building the Docker image. Building docker image is possible via series of commands:

```
git clone https://github.com/ligato/vpp-agent
cd vpp_agent/docker/dev_vpp_agent
sudo docker build -t dev_vpp_agent --build-arg AGENT_COMMIT=<agent commit id>\
--build-arg VPP_COMMIT=<vpp commit id> --no-cache .
sudo ./shrink.sh
cd ../prod_vpp_agent
sudo ./build.sh
sudo ./shrink.sh
```

CSIT requires Docker image to include the desired VPP version (per patch testing, nightly testing, on demand testing).

The entire build process of building dev\_vpp\_agent image heavily depends on internet connectivity and also takes a significant amount of time (~1-1.5h based on internet bandwidth and allocated resources). The optimal solution would be to build the image on jenkins slave, transfer the Docker image to DUTs and execute separate suite of tests.

To adress the amount of time required to build dev\_vpp\_agent image, we can pull existing specific version of `dev\_vpp\_agent` and extract the `vpp-agent` from it.

We created separate sets of Jenkins jobs, that will be executing following:

1. Clone latest CSIT and Ligato repositories.
2. Pull specific version of dev\_vpp\_agent image from Dockerhub.
3. Extract VPP API (from .deb package) and copy into dev\_vpp\_agent image
4. Rebuild vpp-agent and extract outside image.
5. Build prod\_vpp\_image Docker image from dev\_vpp\_agent image.
6. Transfer prod\_vpp\_agent image to DUTs.
7. Execute subset of performance tests designed for Ligato testing.

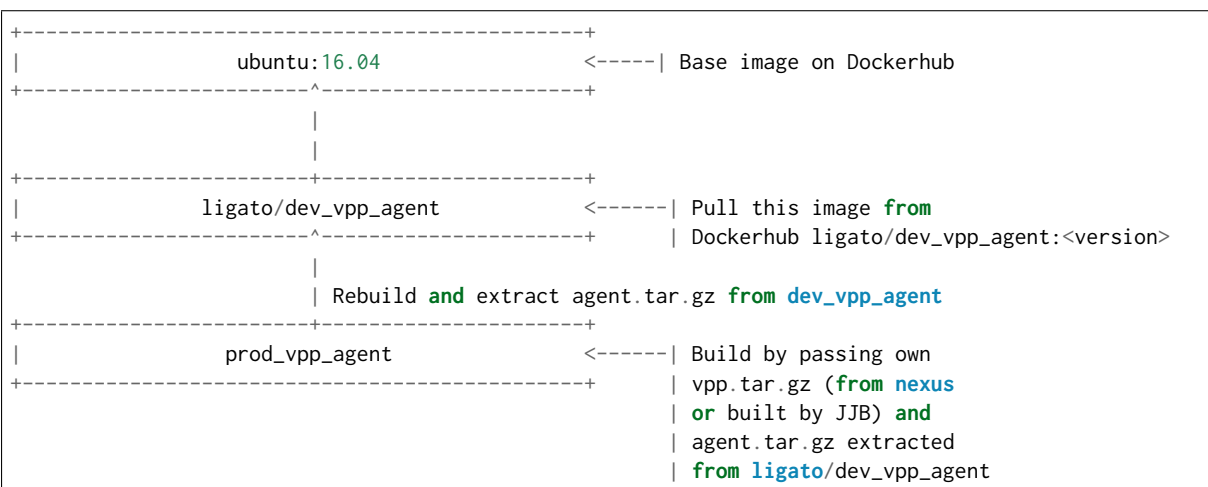

Approximate size of vnf-agent docker images:

REPOSITORY	TAG	IMAGE ID	CREATED	SIZE
dev-vpp-agent	latest	78c53bd57e2	6 weeks ago	9.79GB
prod_vpp_agent	latest	f68af5afe601	5 weeks ago	443MB

In CSIT we need to create separate performance suite under `tests/kubernetes/perf` which contains modified Suite setup in comparison to standard perf tests. This is due to reason that VPP will act as vswitch in Docker image and not as standalone installed service.

## Tested Topologies

Listed CSIT container networking test topologies are defined with DUT containerized VPP switch forwarding packets between NF containers. Each NF container runs their own instance of VPP in L2XC configuration.

Following container networking topologies are tested in CSIT-1901:

- LXC topologies:
  - eth-l2xcbase-eth-2memif-1lxc.
  - eth-l2bdbasemaclrn-eth-2memif-1lxc.
- Docker topologies:
  - eth-l2xcbase-eth-2memif-1docker.
  - eth-l2xcbase-eth-1memif-1docker
- Kubernetes/Ligato topologies:
  - eth-1drcl2bdbasemaclrn-eth-2memif-1drcl2xc-1paral
  - eth-1drcl2bdbasemaclrn-eth-2memif-2drcl2xc-1horiz
  - eth-1drcl2bdbasemaclrn-eth-2memif-4drcl2xc-1horiz
  - eth-1drcl2bdbasemaclrn-eth-4memif-2drcl2xc-1chain
  - eth-1drcl2bdbasemaclrn-eth-8memif-4drcl2xc-1chain
  - eth-1drcl2xcbase-eth-2memif-1drcl2xc-1paral
  - eth-1drcl2xcbase-eth-2memif-2drcl2xc-1horiz
  - eth-1drcl2xcbase-eth-2memif-4drcl2xc-1horiz
  - eth-1drcl2xcbase-eth-4memif-2drcl2xc-1chain
  - eth-1drcl2xcbase-eth-8memif-4drcl2xc-1chain

## References

### 2.11.2 Test Code Documentation

CSIT VPP Performance Tests Documentation<sup>128</sup> contains detailed functional description and input parameters for each test case.

<sup>128</sup> <https://docs.fd.io/csit/rls1901/doc/tests.vpp.perf.html>

### 3.1 Overview

DPDK performance test results are reported for all three physical testbed types present in FD.io labs: 3-Node Xeon Haswell (3n-hsw), 3-Node Xeon Skylake (3n-skx), 2-Node Xeon Skylake (2n-skx) and installed NIC models. For description of physical testbeds used for DPDK performance tests please refer to *Physical Testbeds* (page 4).

#### 3.1.1 Logical Topologies

CSIT DPDK performance tests are executed on physical testbeds described in *Physical Testbeds* (page 4). Based on the packet path through server SUTs, one distinct logical topology type is used for DPDK DUT data plane testing: NIC-to-NIC switching topology.

##### NIC-to-NIC Switching

The simplest logical topology for software data plane application like DPDK is NIC-to-NIC switching. Tested topologies for 2-Node and 3-Node testbeds are shown in figures below.

## 2-Node Topology: NIC-to-NIC Switching

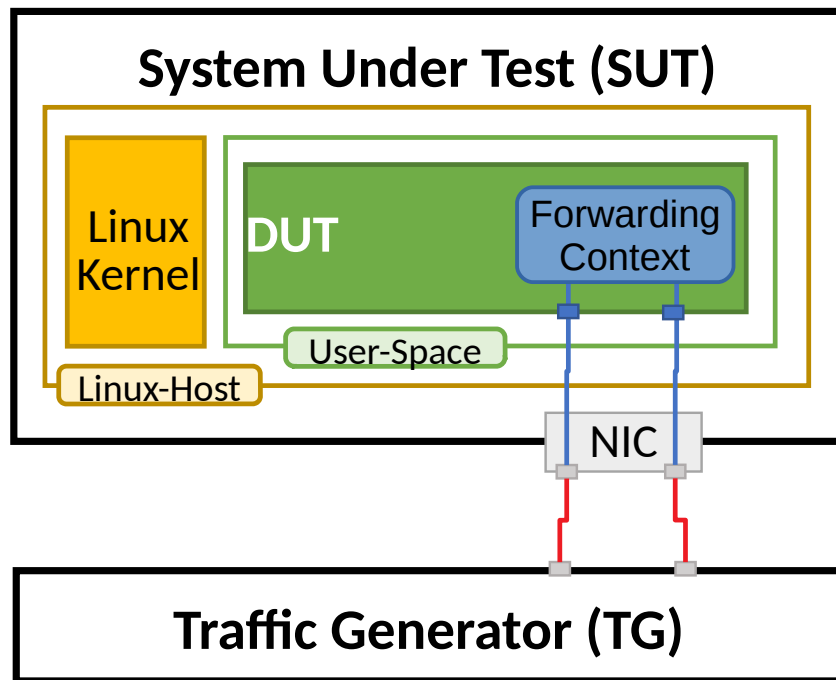

## 3-Node Topology: NIC-to-NIC Switching

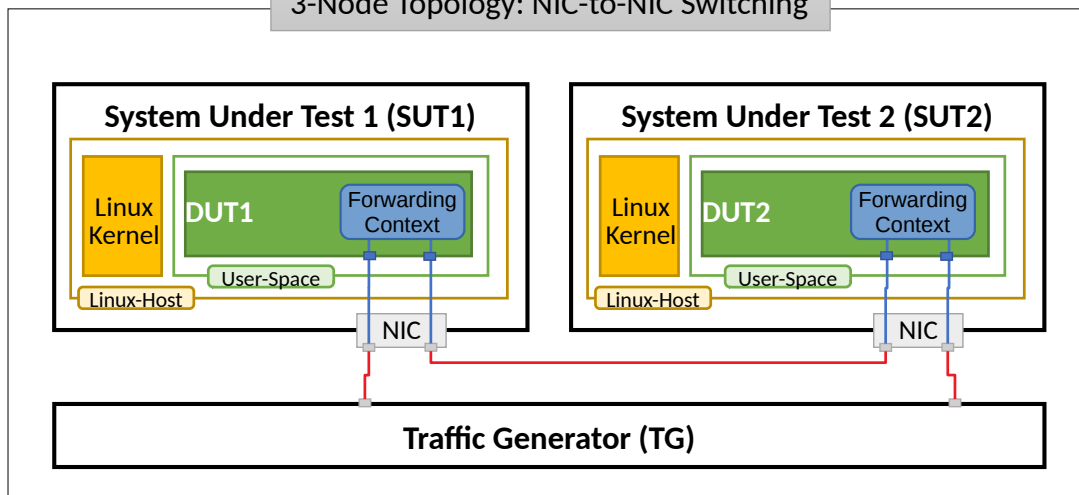

Server Systems Under Test (SUT) run DPDK Testpmd or L3fwd application in Linux user-mode as a Device Under Test (DUT). Server Traffic Generator (TG) runs T-Rex application. Physical connectivity between SUTs and TG is provided using different drivers and NIC models that need to be tested for performance (packet/bandwidth throughput and latency).

From SUT and DUT perspectives, all performance tests involve forwarding packets between two physical Ethernet ports (10GE, 25GE, 40GE, 100GE). In most cases both physical ports on SUT are located on the same NIC. The only exceptions are link bonding and 100GE tests. In the latter case only one port per NIC can be driven at linerate due to PCIe Gen3 x16 slot bandwidth limitations. 100GE NICs are not supported in PCIe Gen3 x8 slots.

Note that reported DPDK DUT performance results are specific to the SUTs tested. SUTs with other processors than the ones used in FD.io lab are likely to yield different results. A good rule of thumb, that can be applied to estimate DPDK packet throughput for NIC-to-NIC switching topology, is to expect the forwarding performance to be proportional to processor core frequency for the same processor architecture, assuming processor is the only limiting factor and all other SUT parameters are equivalent to FD.io CSIT environment.

### 3.1.2 Performance Tests Coverage

Performance tests measure following metrics for tested DPDK DUT topologies and configurations:

- Packet Throughput: measured in accordance with **RFC 2544**<sup>129</sup>, using FD.io CSIT Multiple Loss Ratio search (MLRsearch), an optimized binary search algorithm, producing throughput at different Packet Loss Ratio (PLR) values:
  - Non Drop Rate (NDR): packet throughput at PLR=0%.
  - Partial Drop Rate (PDR): packet throughput at PLR=0.5%.
- One-Way Packet Latency: measured at different offered packet loads:
  - 100% of discovered NDR throughput.
  - 100% of discovered PDR throughput.
- Maximum Receive Rate (MRR): measured packet forwarding rate under the maximum load offered by traffic generator over a set trial duration, regardless of packet loss. Maximum load for specified Ethernet frame size is set to the bi-directional link rate.

CSIT-1901 includes following DPDK Testpmd and L3fwd data plane functionality performance tested across a range of NIC drivers and NIC models:

Functionality	Description
L2IntLoop	L2 Interface Loop forwarding all Ethernet frames between two Interfaces.
IPv4 Routed Forwarding	Longest Prefix Match (LPM) L3 IPv4 forwarding of Ethernet frames between two Interfaces, with two /8 prefixes in lookup table.

## 3.2 Release Notes

### 3.2.1 Changes in CSIT-1901

#### 1. DPDK RELEASE VERSION CHANGE

- CSIT-1901 tested DPDK 18.11, as used by VPP-19.01 release.

### 3.2.2 Known Issues

No known issues.

---

<sup>129</sup> <https://tools.ietf.org/html/rfc2544.html>

### 3.3 Packet Throughput

Throughput graphs are generated by multiple executions of the same performance tests across physical testbeds hosted LF FD.io labs: 3n-hsw, 2n-skx, 2n-skx. Box-and-Whisker plots are used to display variations in measured throughput values, without making any assumptions of the underlying statistical distribution.

For each test case, Box-and-Whisker plots show the quartiles (Min, 1st quartile / 25th percentile, 2nd quartile / 50th percentile / mean, 3rd quartile / 75th percentile, Max) across collected data set. Outliers are plotted as individual points.

Additional information about graph data:

1. **Graph Title:** describes tested packet path, testbed topology, processor model, NIC model, packet size, number of cores and threads used by data plane workers and indication of DPDK DUT configuration.
2. **X-axis Labels:** indices of individual test suites as listed in Graph Legend.
3. **Y-axis Labels:** measured Packets Per Second [pps] throughput values.
4. **Graph Legend:** lists X-axis indices with associated CSIT test suites executed to generate graphed test results.
5. **Hover Information:** lists minimum, first quartile, median, third quartile, and maximum. If either type of outlier is present the whisker on the appropriate side is taken to  $1.5 \times \text{IQR}$  from the quartile (the “inner fence”) rather than the max or min, and individual outlying data points are displayed as unfilled circles (for suspected outliers) or filled circles (for outliers). (The “outer fence” is  $3 \times \text{IQR}$  from the quartile.)

---

**Note:** Test results have been generated by [FD.io test executor dpdk performance job 3n-hsw<sup>130</sup>](#), [FD.io test executor dpdk performance job 3n-skx<sup>131</sup>](#) and [FD.io test executor dpdk performance job 2n-skx<sup>132</sup>](#) with RF result files csit-dpdk-perf-1901-\*.zip [archived here](#). Required per test case data set size is **10** and for DPDK tests this is the actual size, as all scheduled test executions completed successfully.

---

#### 3.3.1 Testpmd

Following sections include summary graphs of DPDK Testpmd Phy-to-Phy performance with L2 Ethernet Interface Loop, including NDR throughput (zero packet loss) and PDR throughput (<0.5% packet loss). Performance is reported for Testpmd running in multiple configurations of Testpmd pmd thread(s), a.k.a. Testpmd data plane thread(s), and their physical CPU core(s) placement.

CSIT source code for the test cases used for plots can be found in [CSIT git repository<sup>133</sup>](#).

<sup>130</sup> <https://jenkins.fd.io/view/csit/job/csit-dpdk-perf-verify-1901-3n-hsw>

<sup>131</sup> <https://jenkins.fd.io/view/csit/job/csit-dpdk-perf-verify-1901-3n-skx>

<sup>132</sup> <https://jenkins.fd.io/view/csit/job/csit-dpdk-perf-verify-1901-2n-skx>

<sup>133</sup> <https://git.fd.io/csit/tree/tests/dpdk/perf?h=rls1901>



3n-hsw-x520

64b-1t1c-base

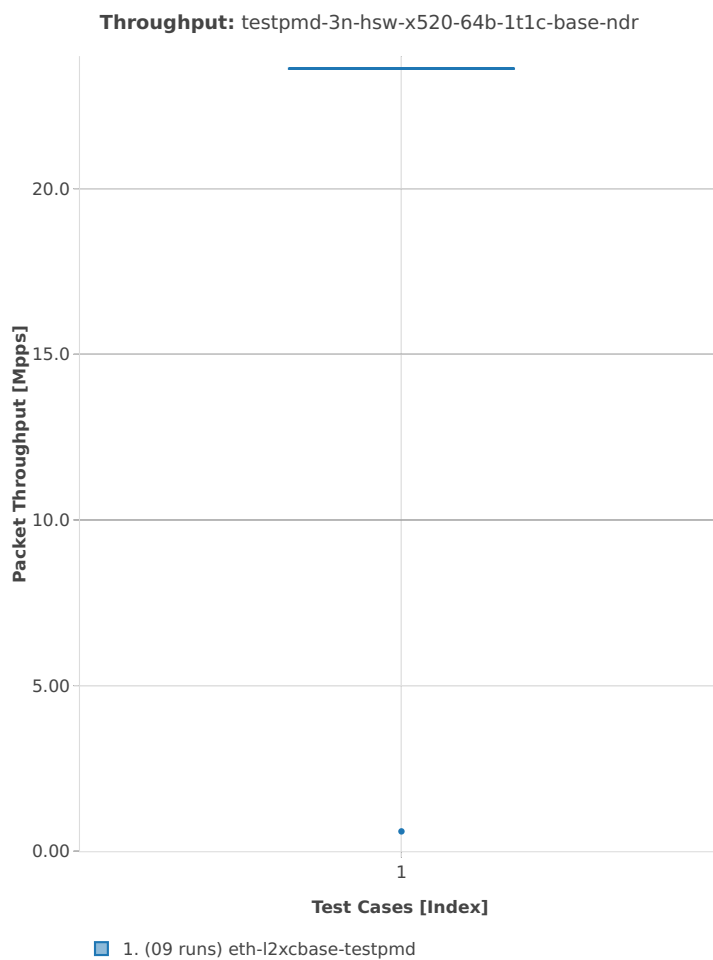

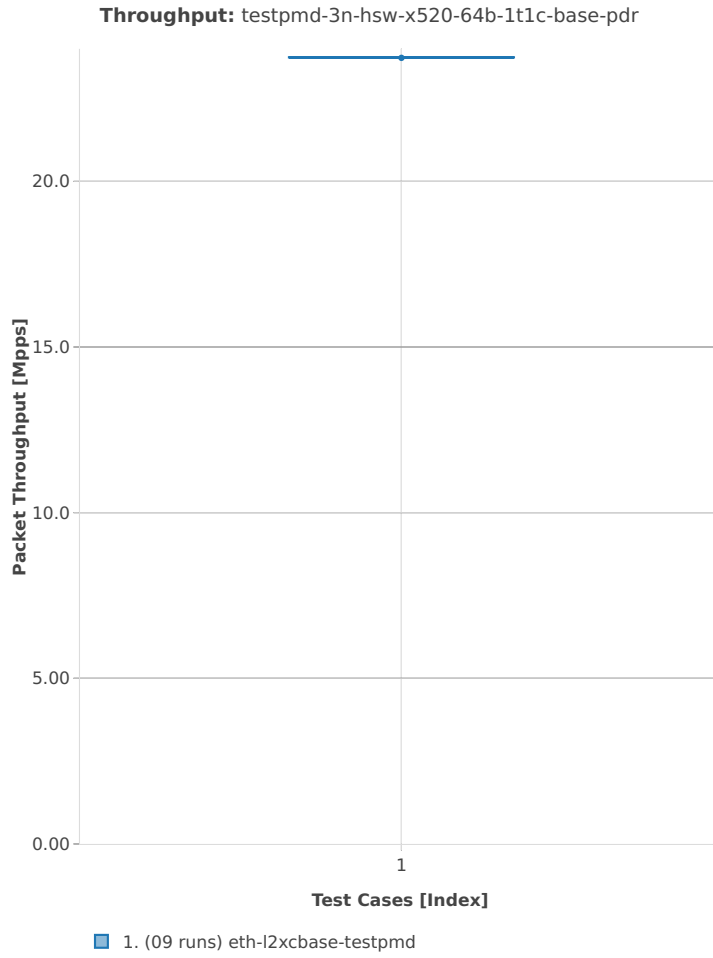

64b-2t2c-base

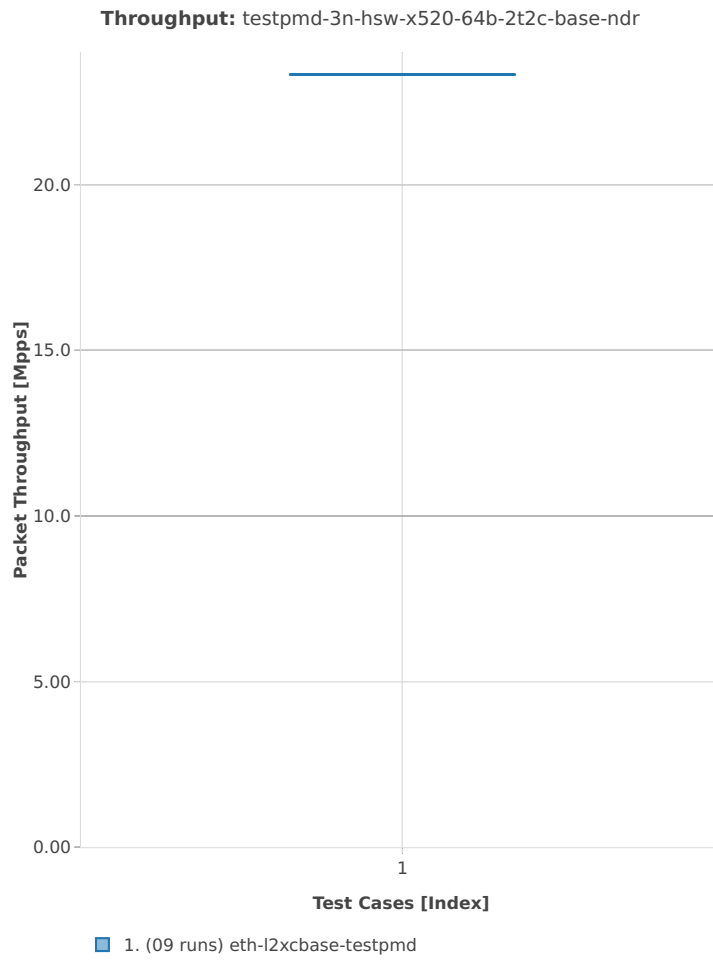

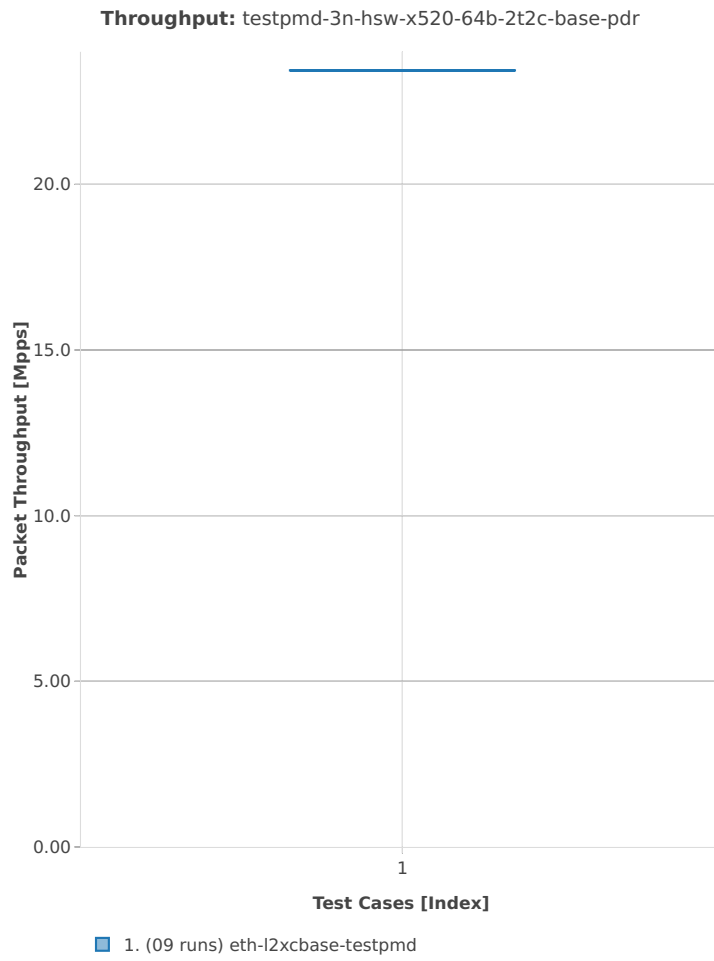

3n-hsw-x710

64b-1t1c-base

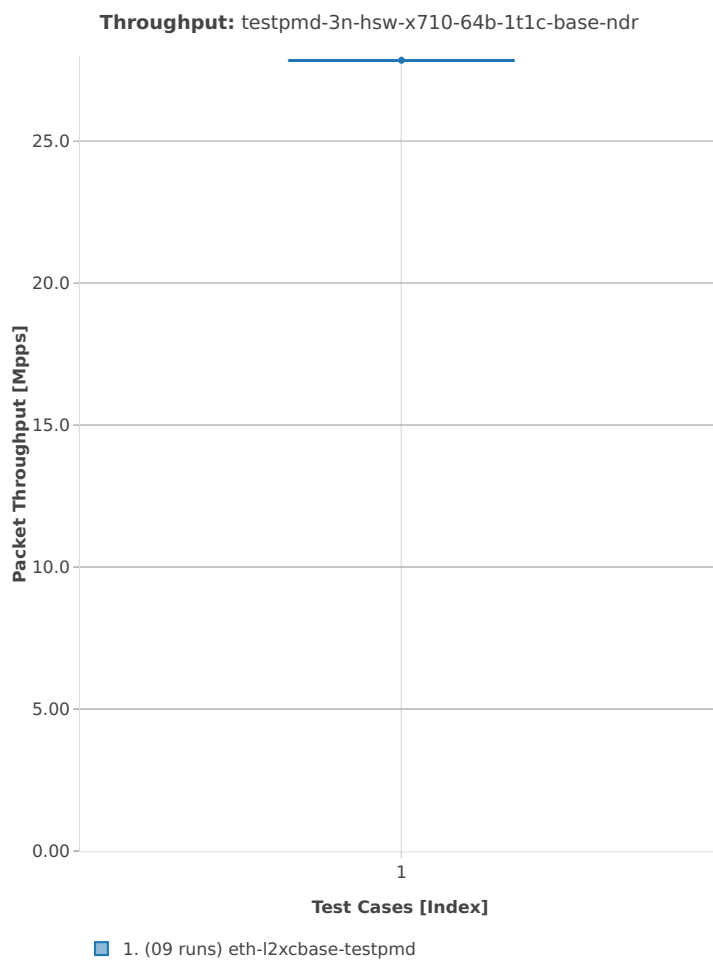

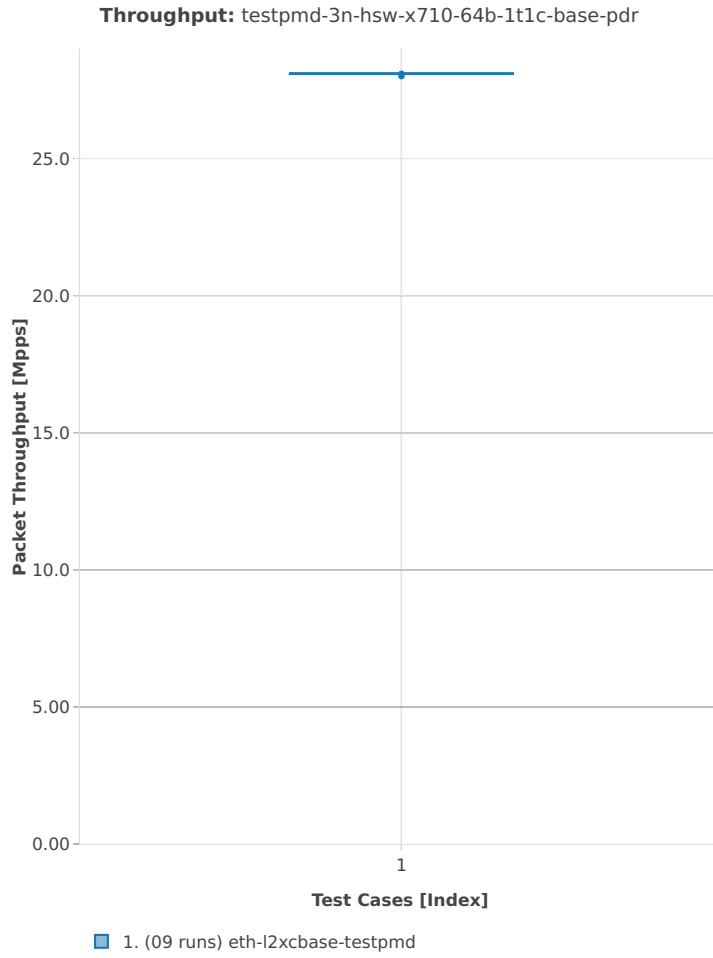

64b-2t2c-base

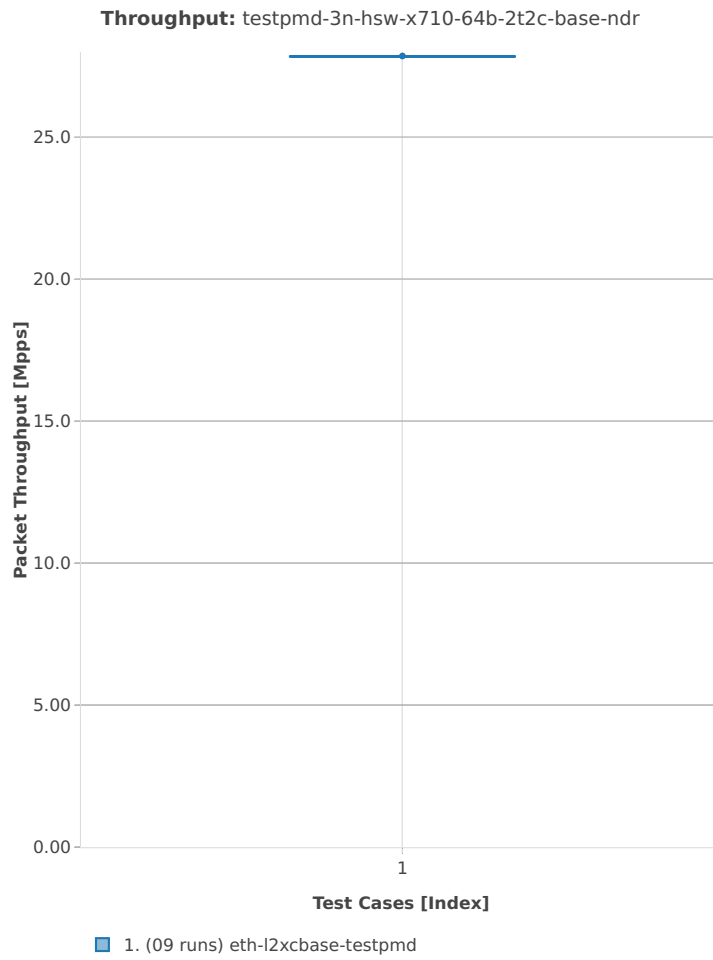

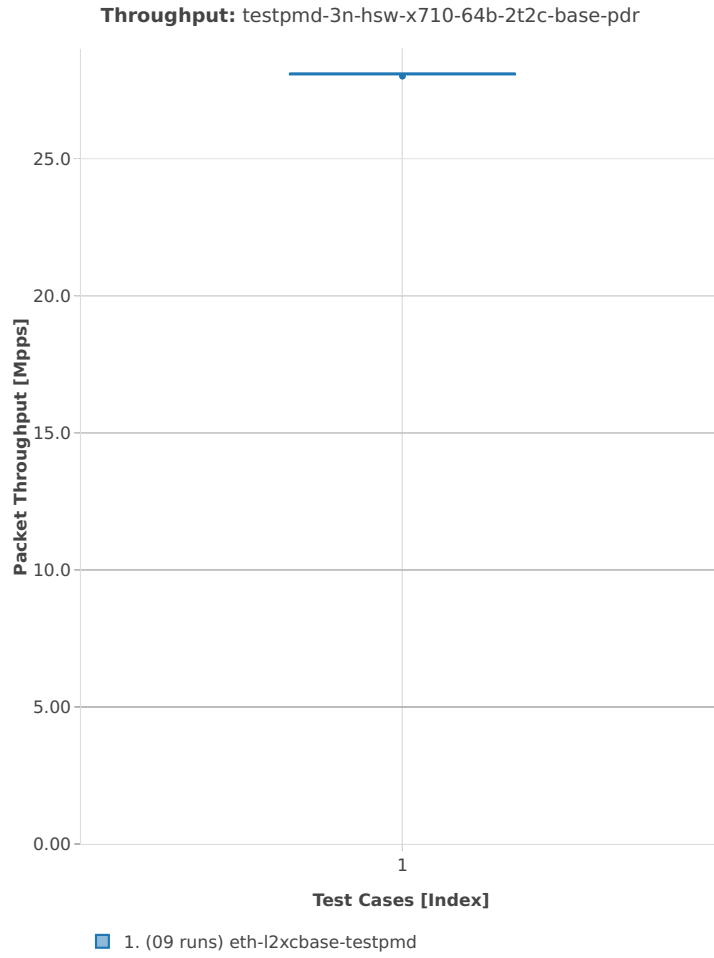



3n-hsw-xl710

64b-1t1c-base

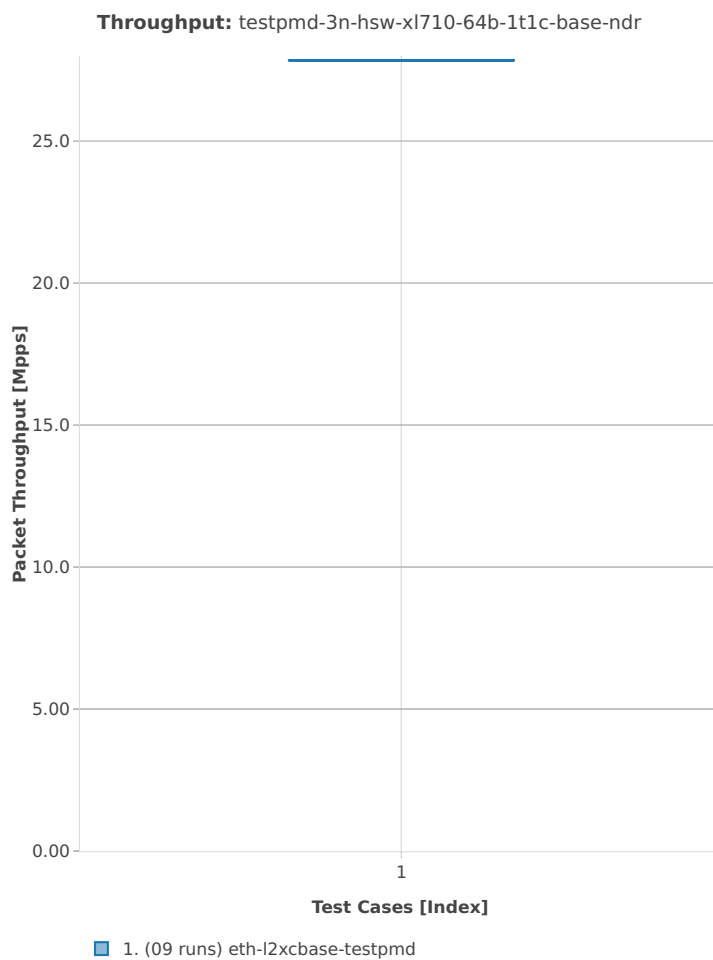

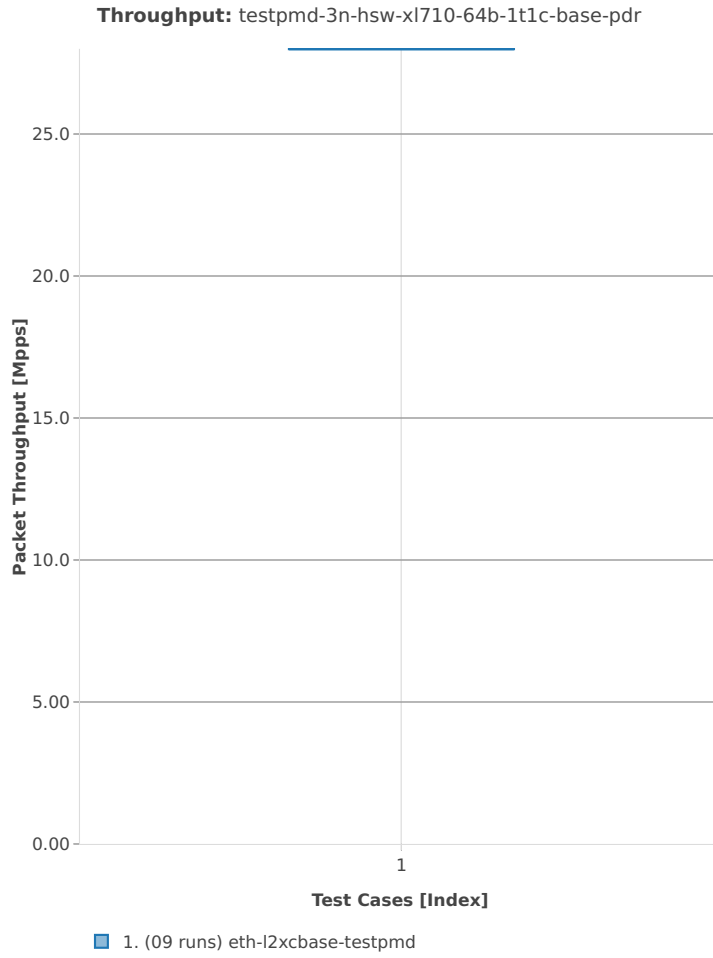

64b-2t2c-base

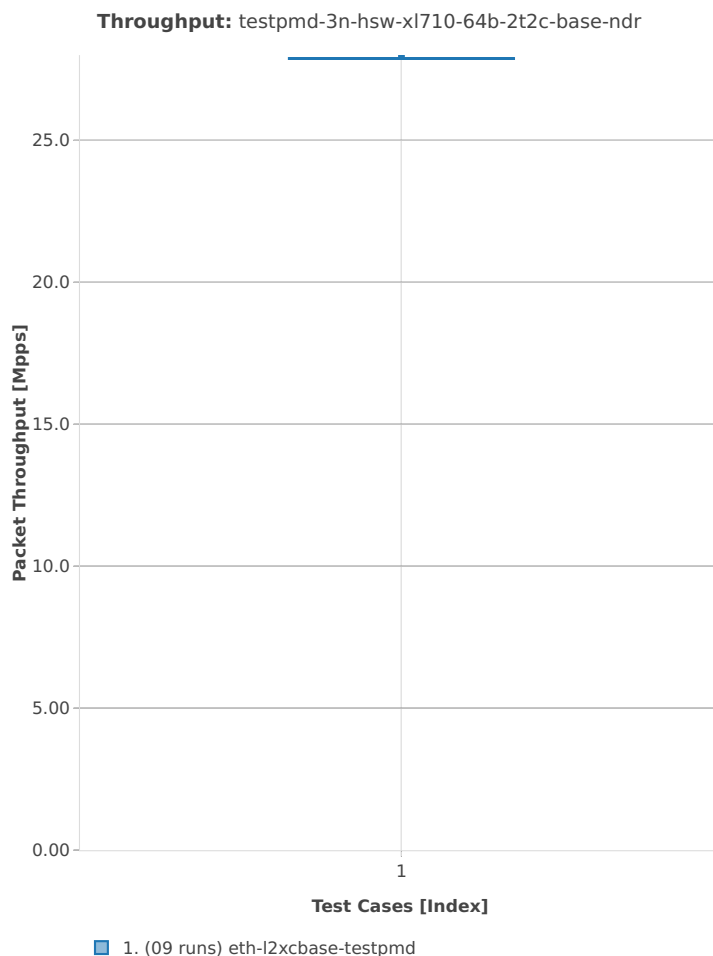

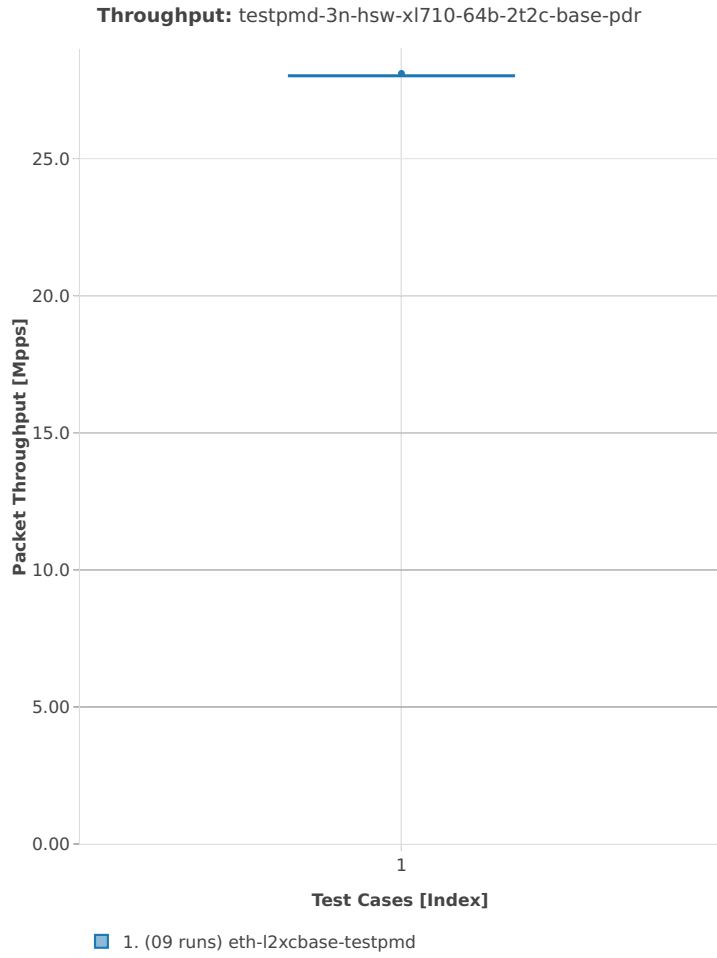

3n-skx-x710

64b-2t1c-base

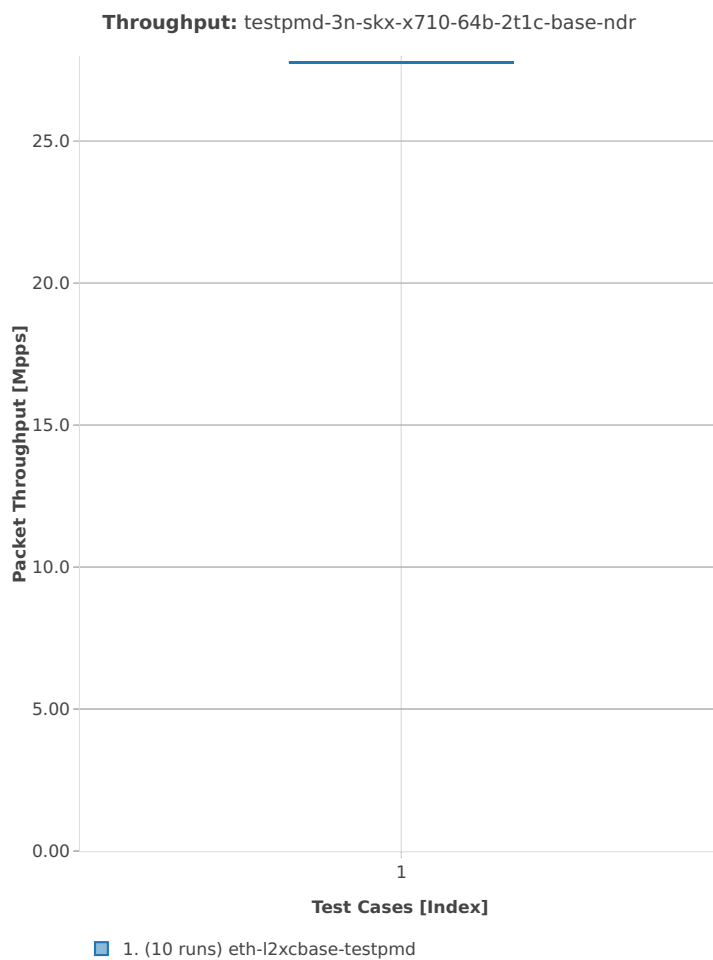

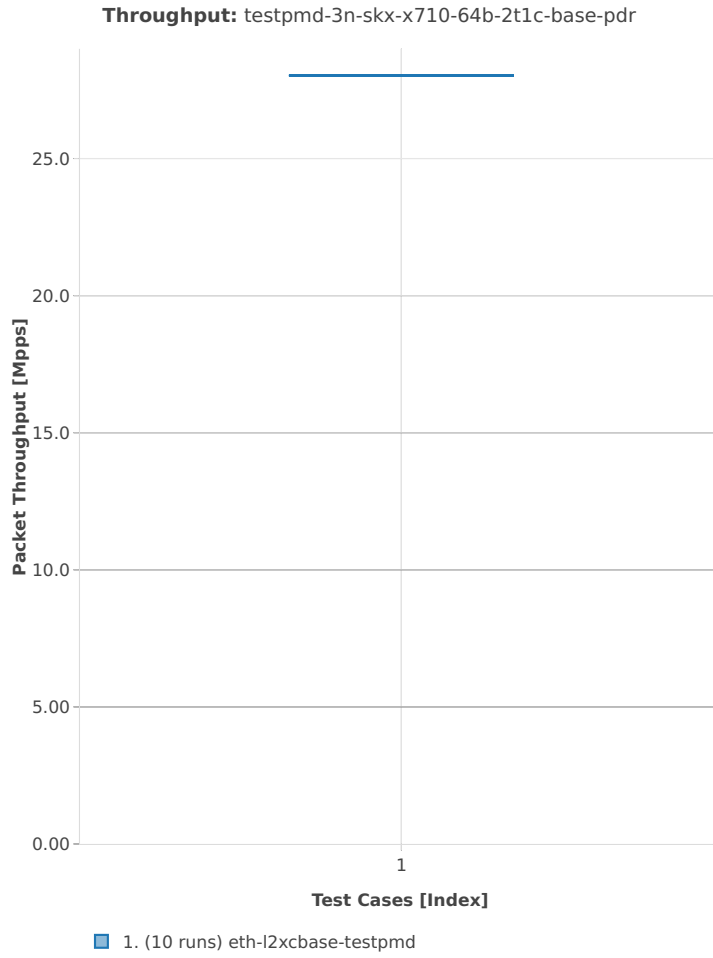

64b-4t2c-base

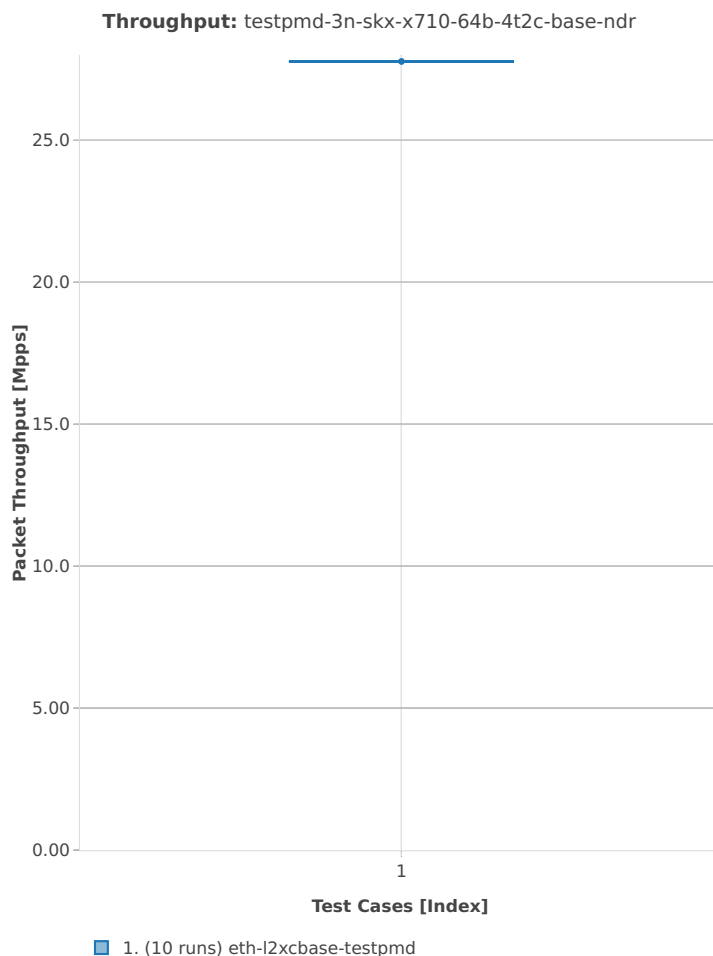

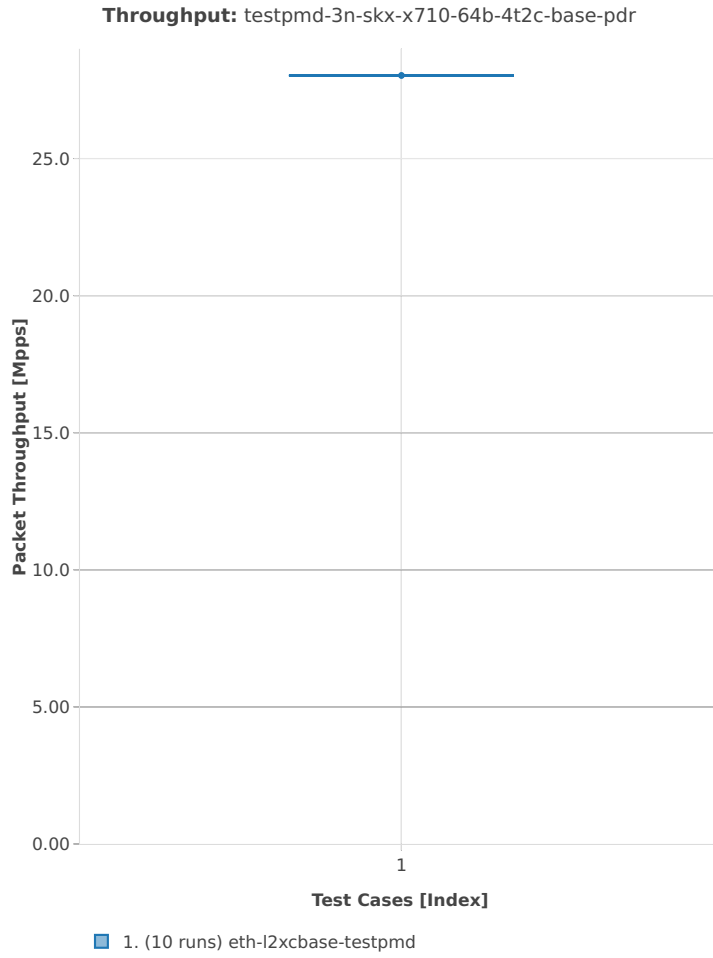



3n-skx-xxv710

64b-2t1c-base

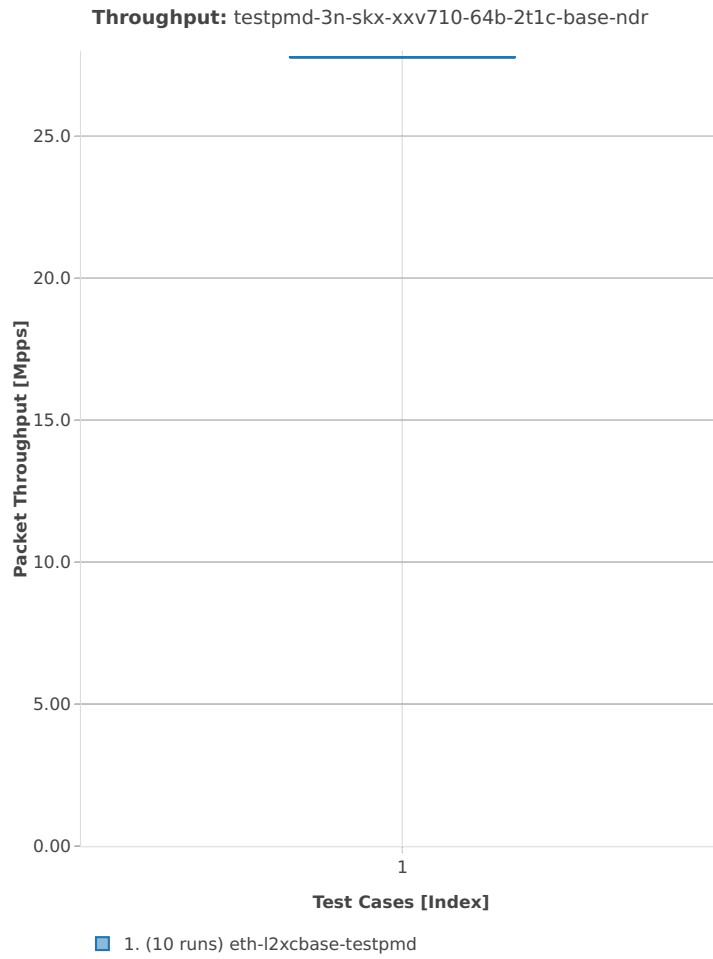

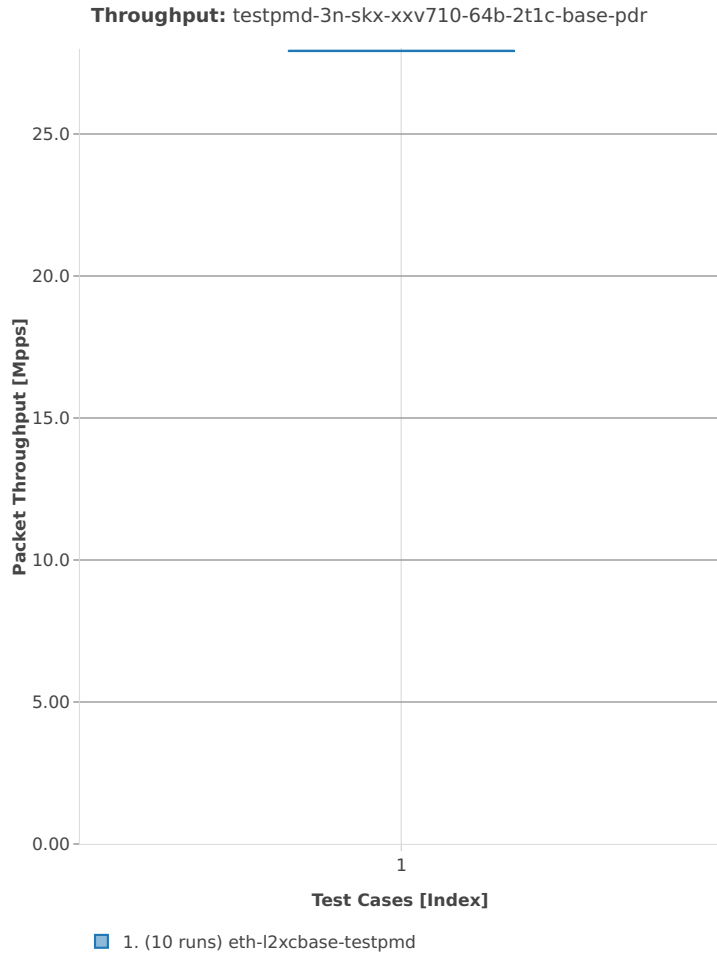

64b-4t2c-base

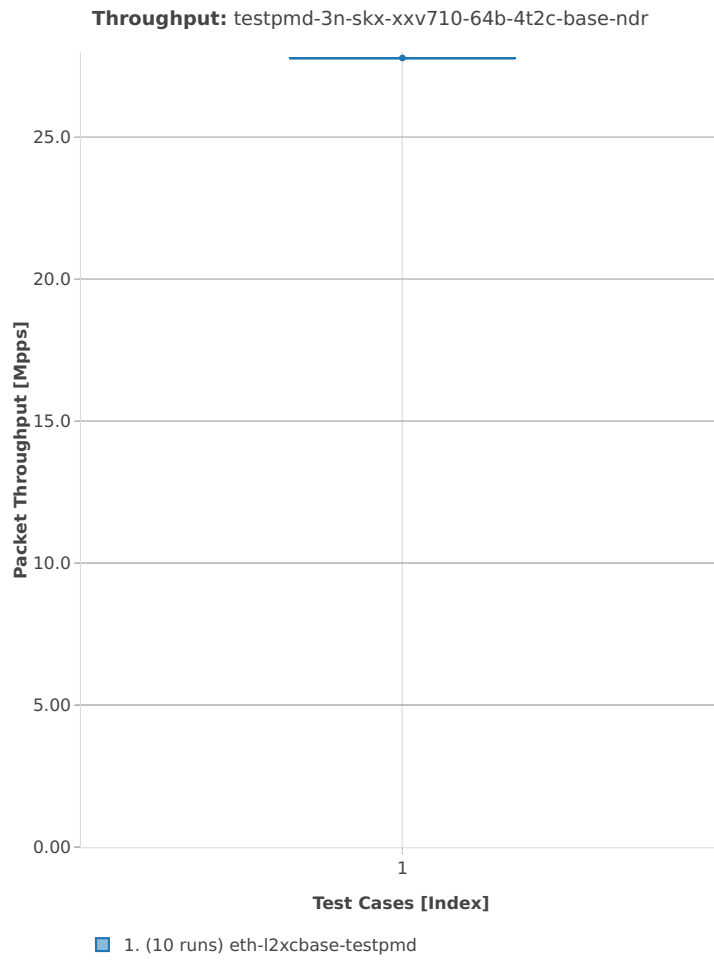

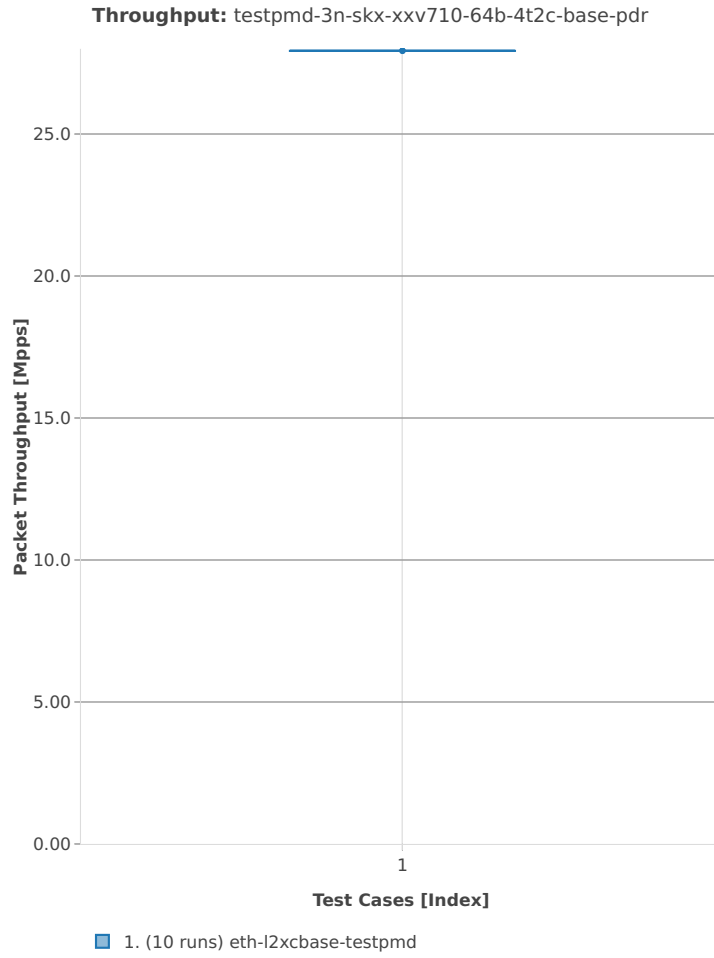

2n-skx-x710

64b-2t1c-base

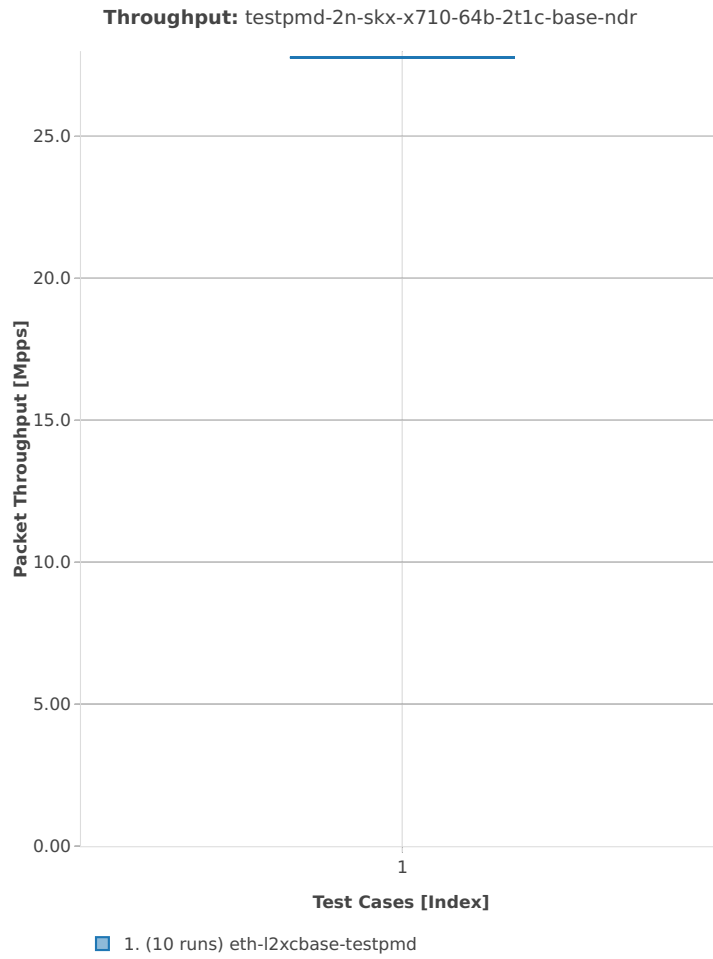

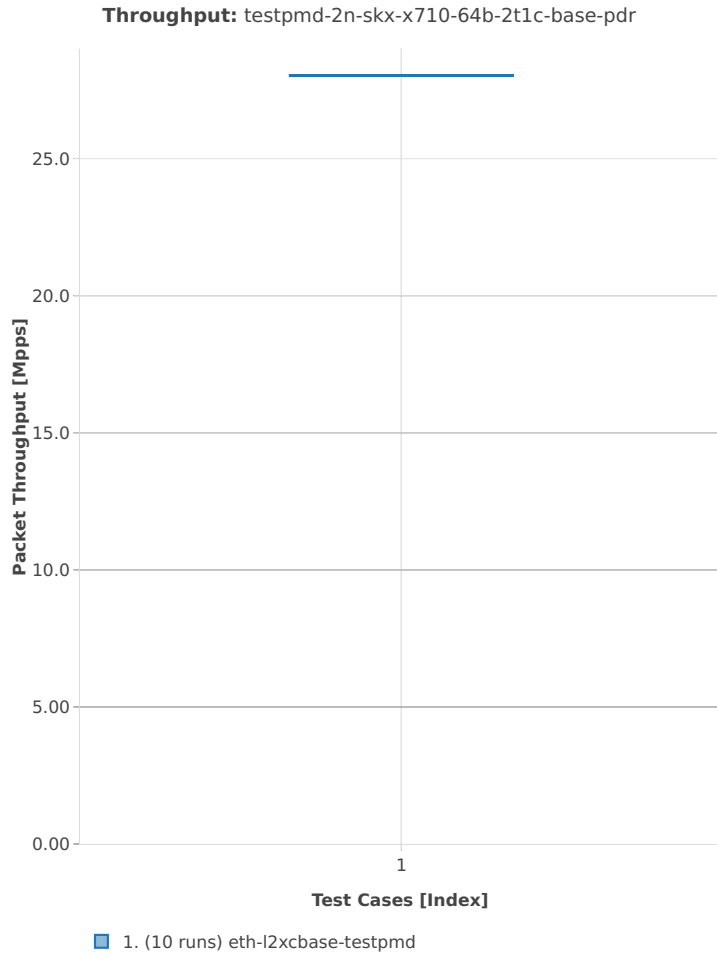

64b-4t2c-base

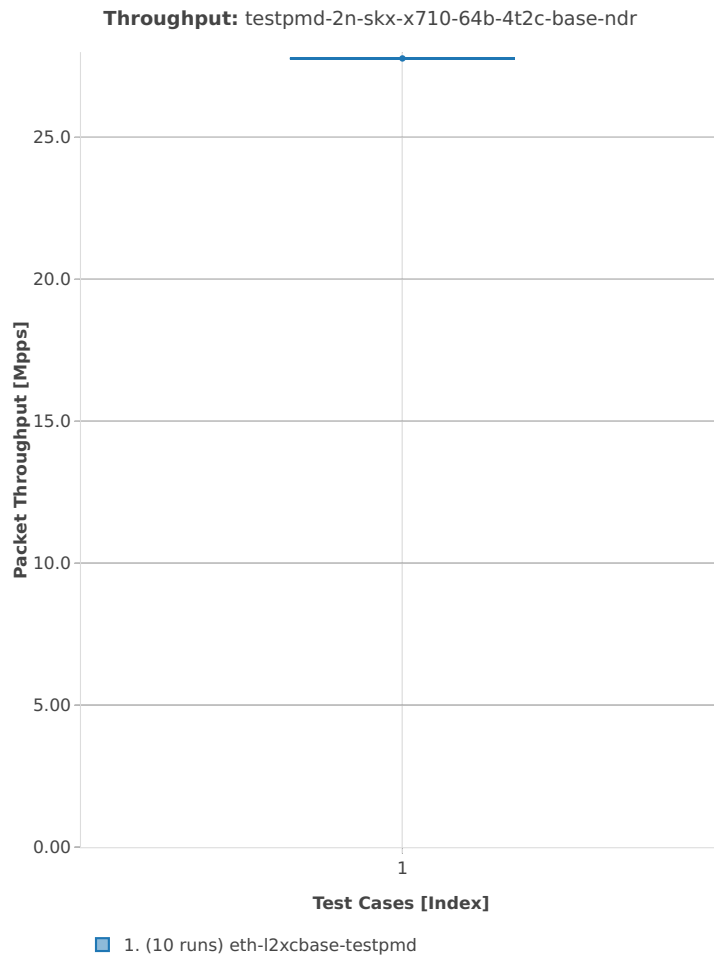

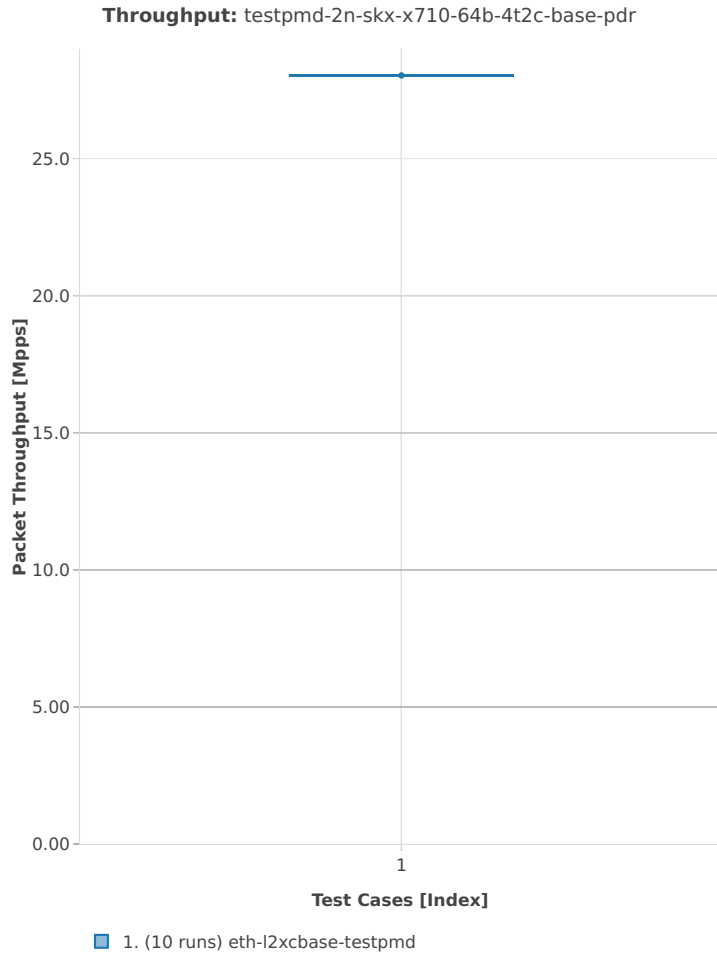



2n-skx-xxv710

64b-2t1c-base

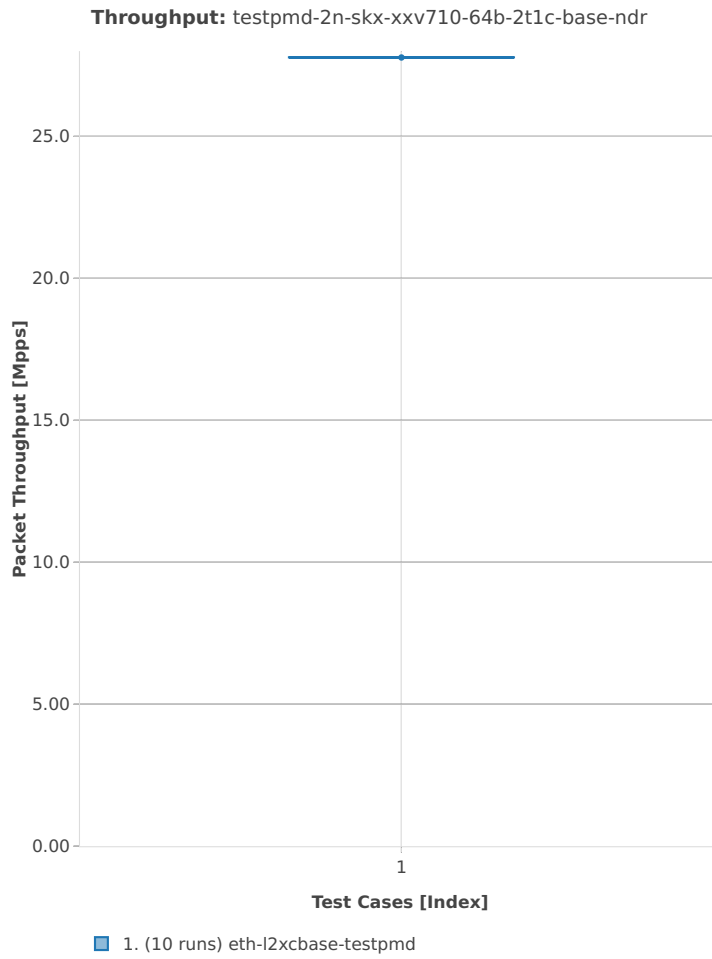

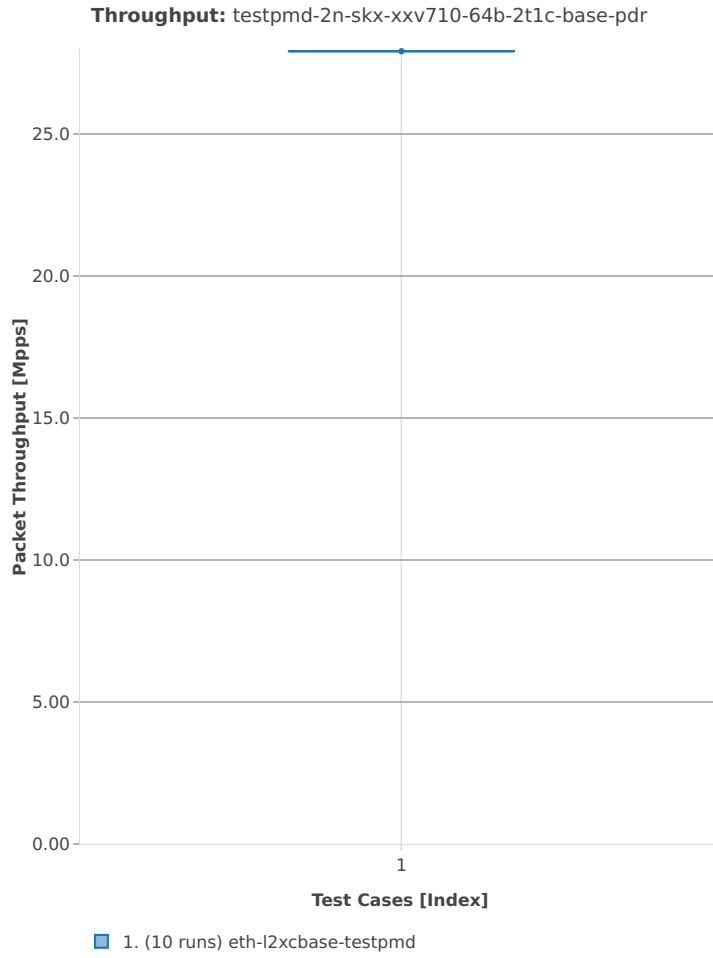

64b-4t2c-base

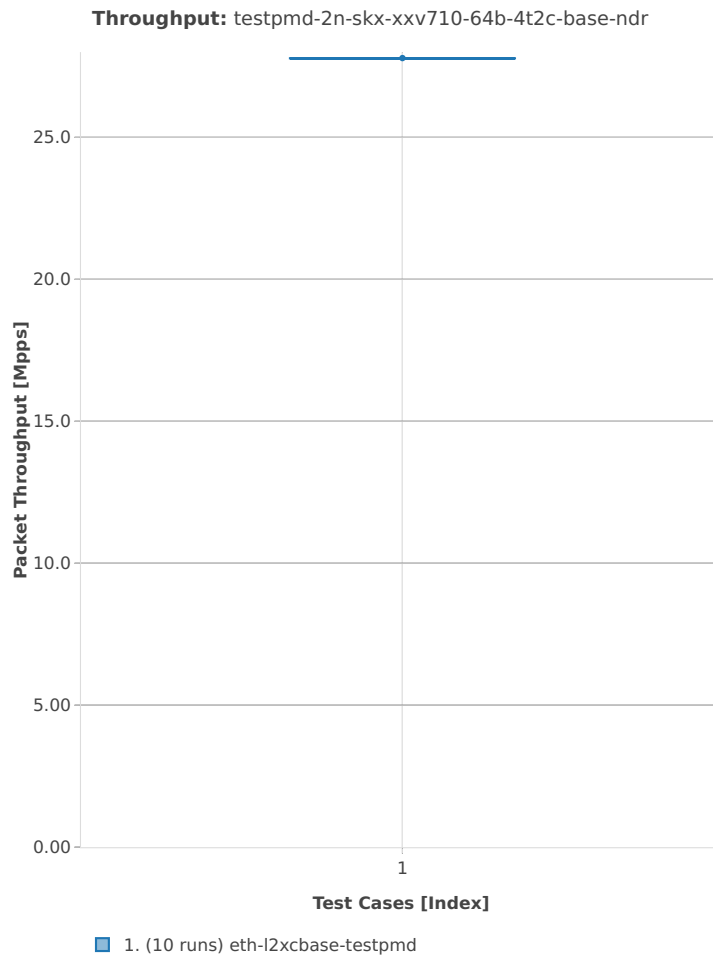

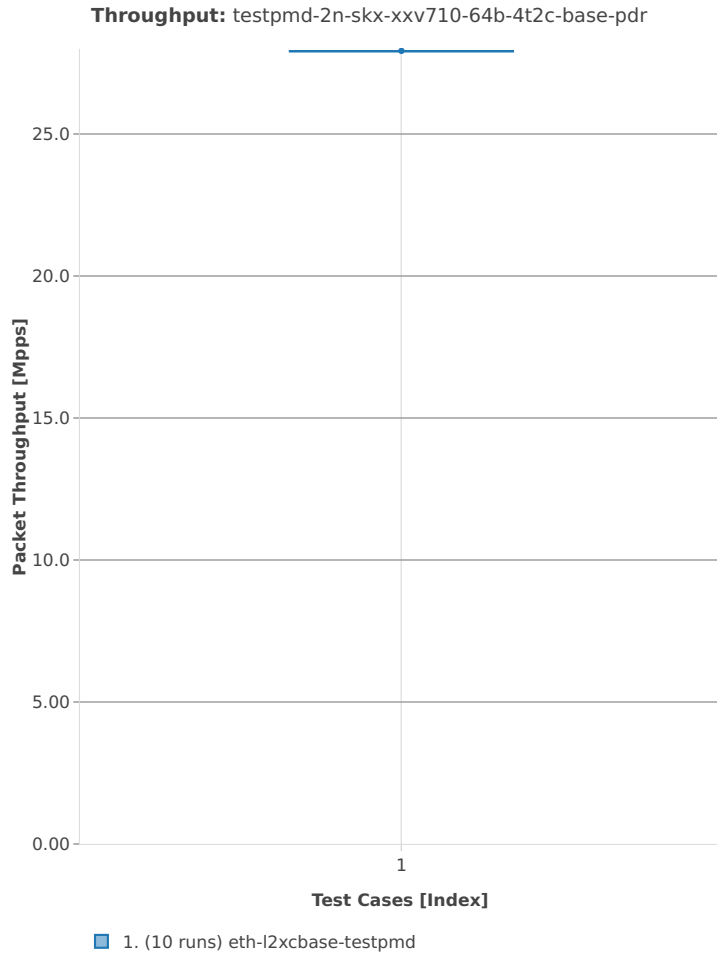

### 3.3.2 L3fwd

Following sections include summary graphs of L3FWD Phy-to-Phy performance with packet routed forwarding, including NDR throughput (zero packet loss) and PDR throughput (<0.5% packet loss). Performance is reported for L3FWD running in multiple configurations of L3FWD pmd thread(s), a.k.a. L3FWD data plane thread(s), and their physical CPU core(s) placement.

CSIT source code for the test cases used for plots can be found in [CSIT git repository](#)<sup>134</sup>.

---

<sup>134</sup> <https://git.fd.io/csit/tree/tests/dpdk/perf?h=rls1901>

3n-hsw-x520

64b-1t1c-base

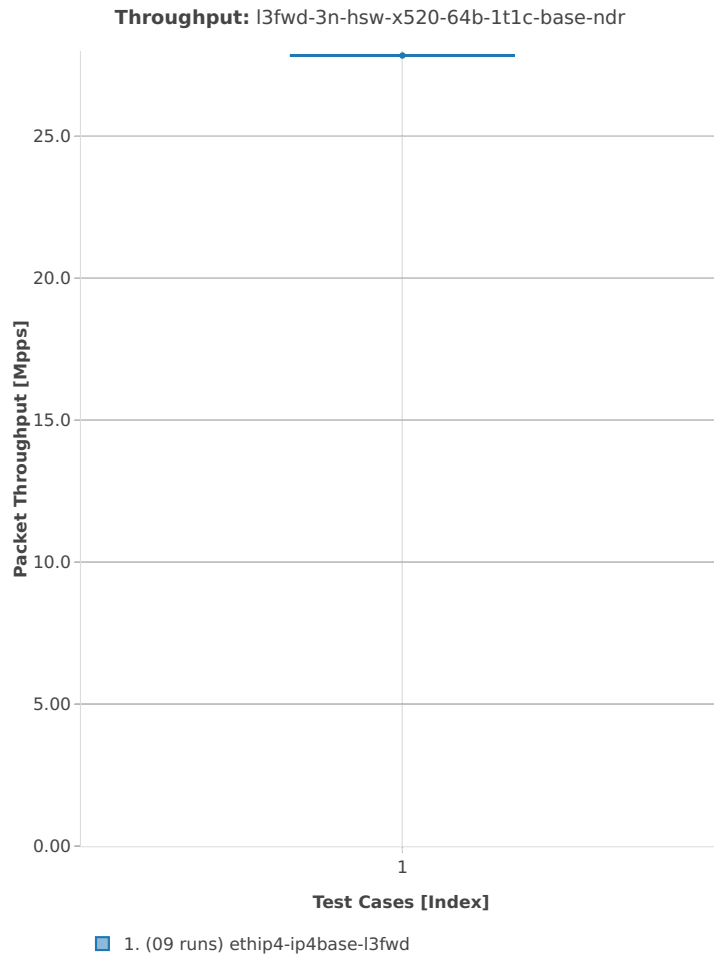

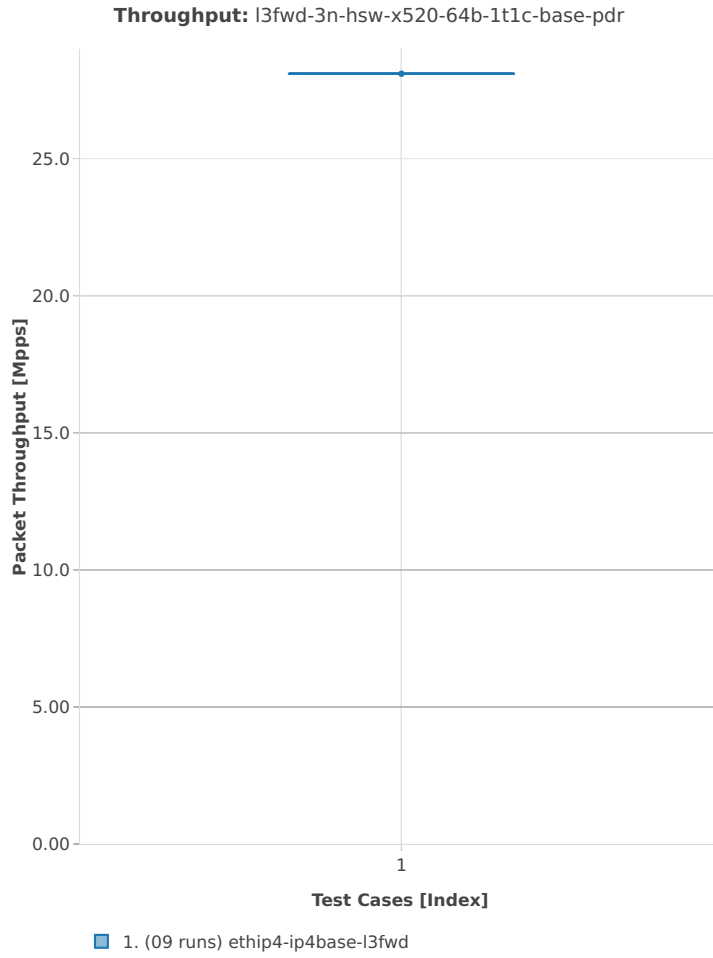

64b-2t2c-base

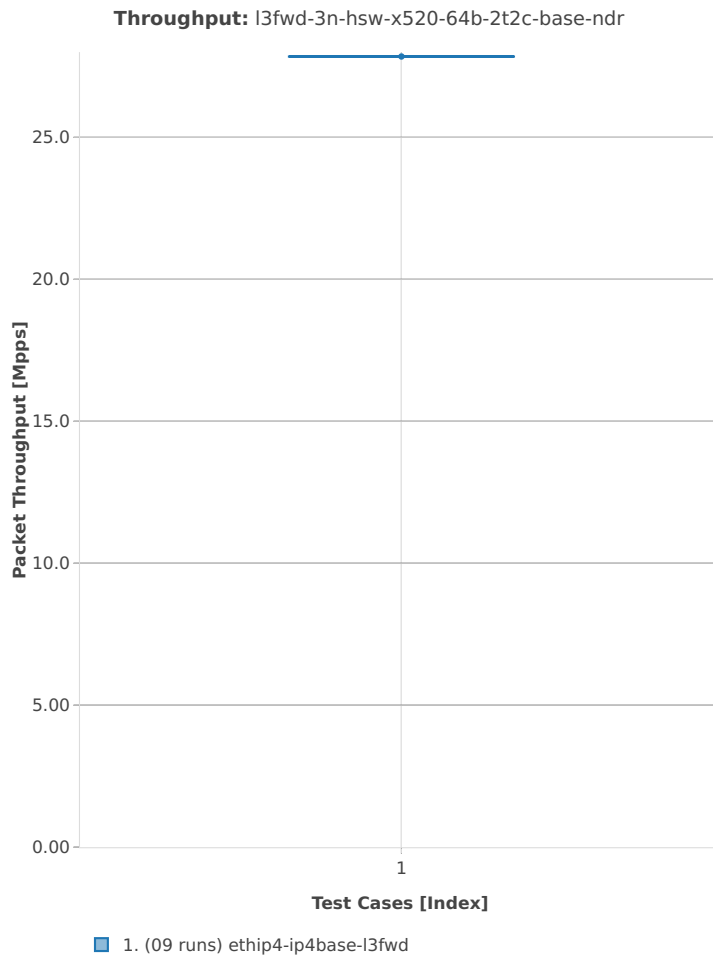



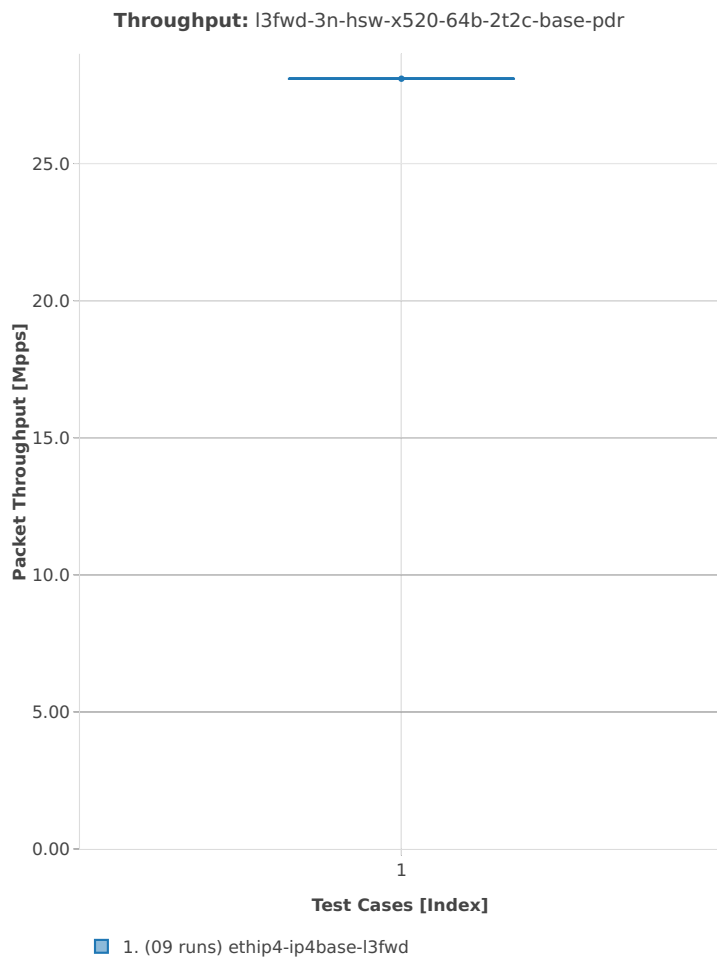

3n-hsw-x710

64b-1t1c-base

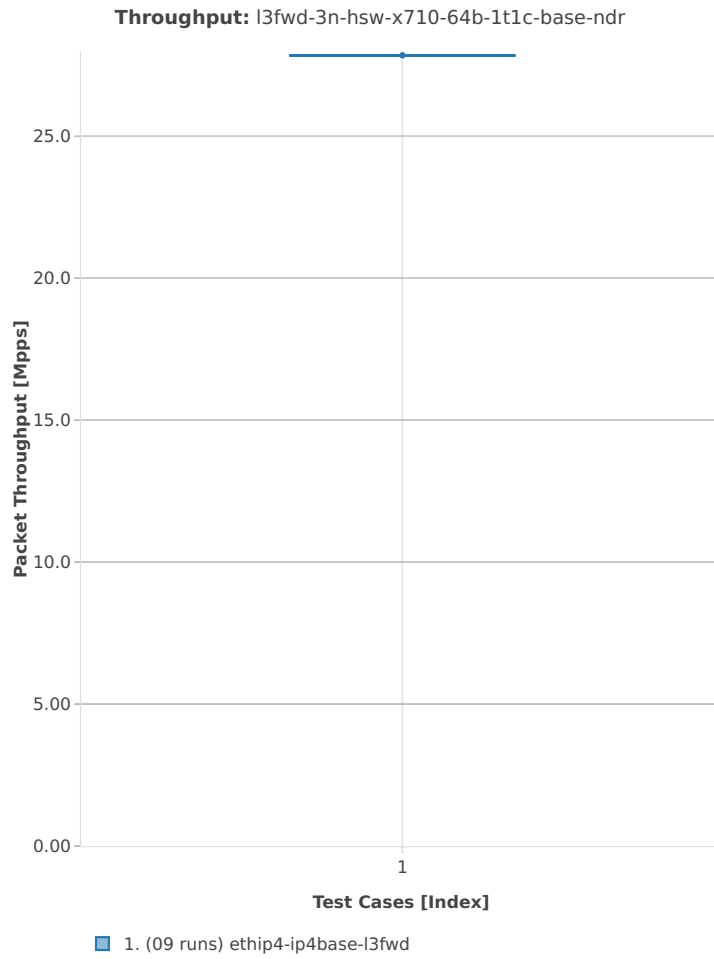

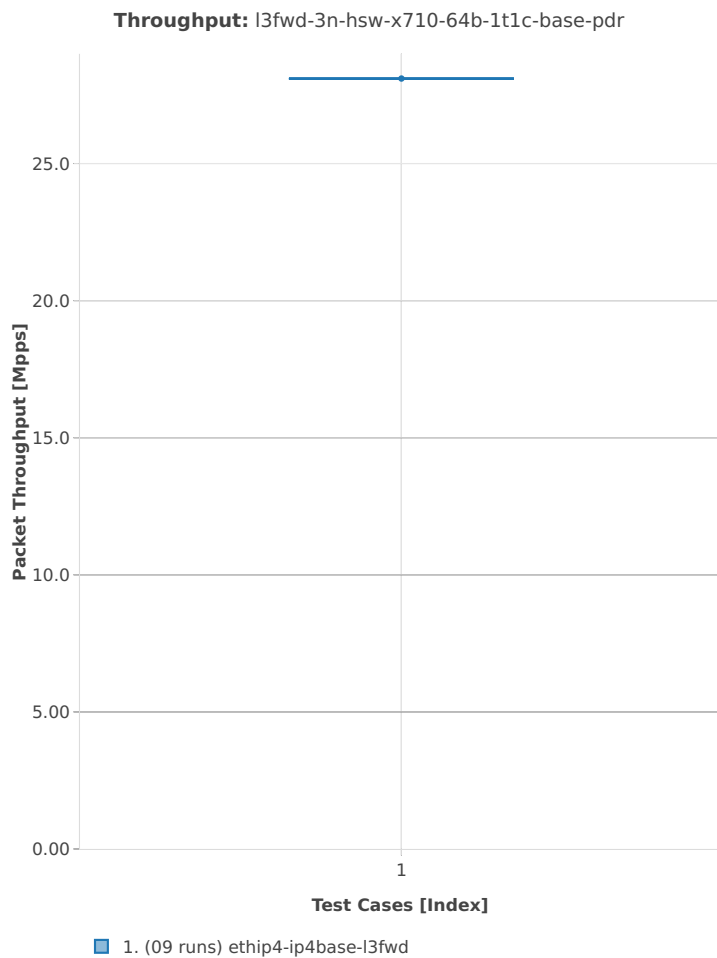

64b-2t2c-base

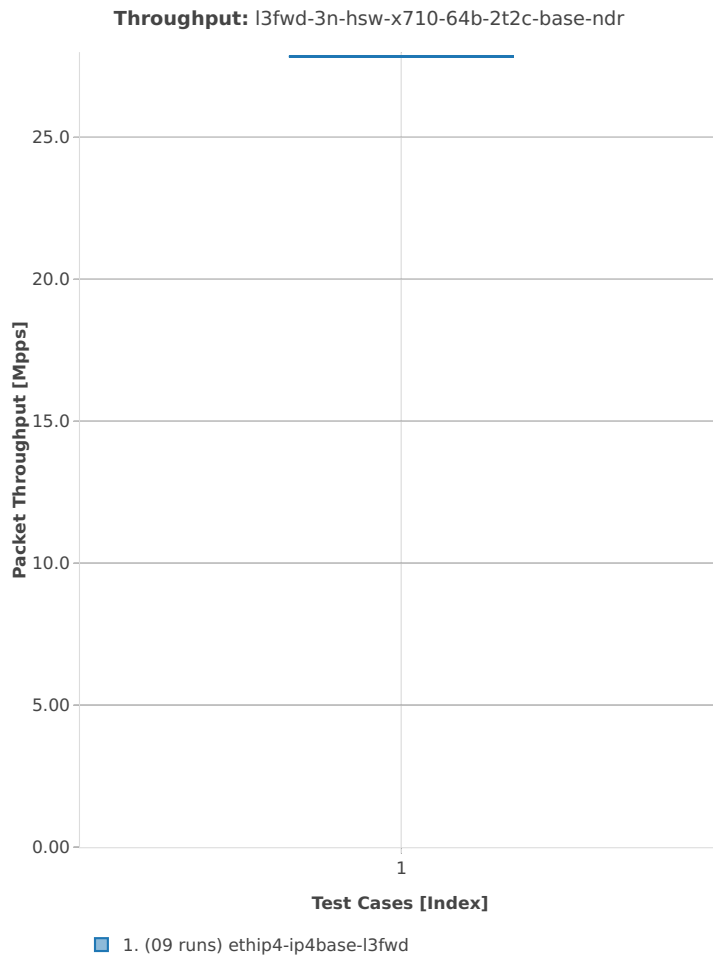

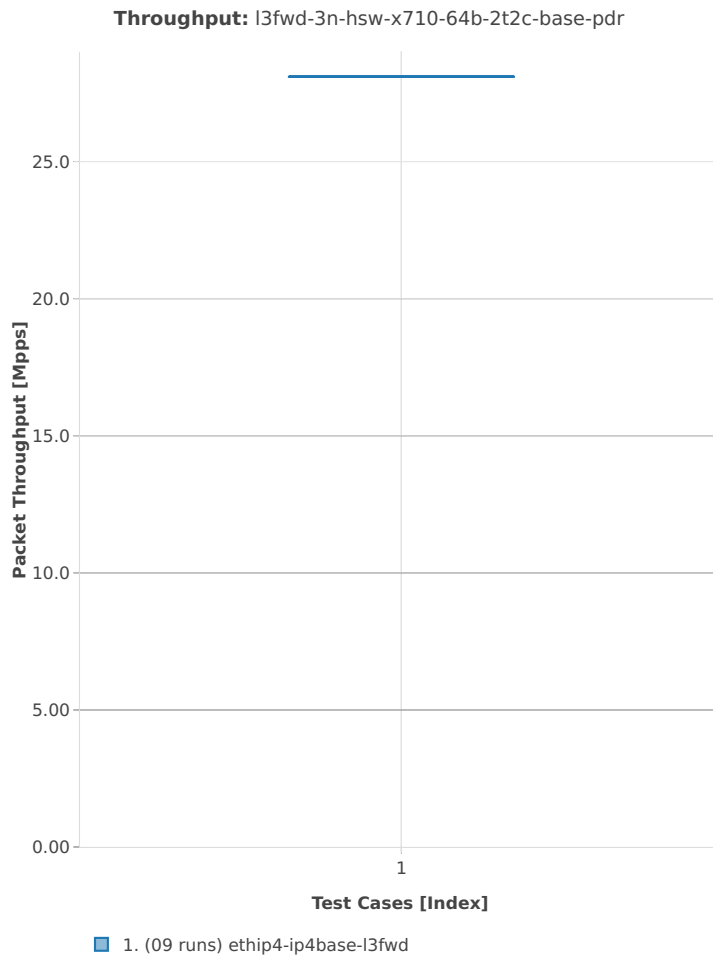

3n-hsw-xl710

64b-1t1c-base

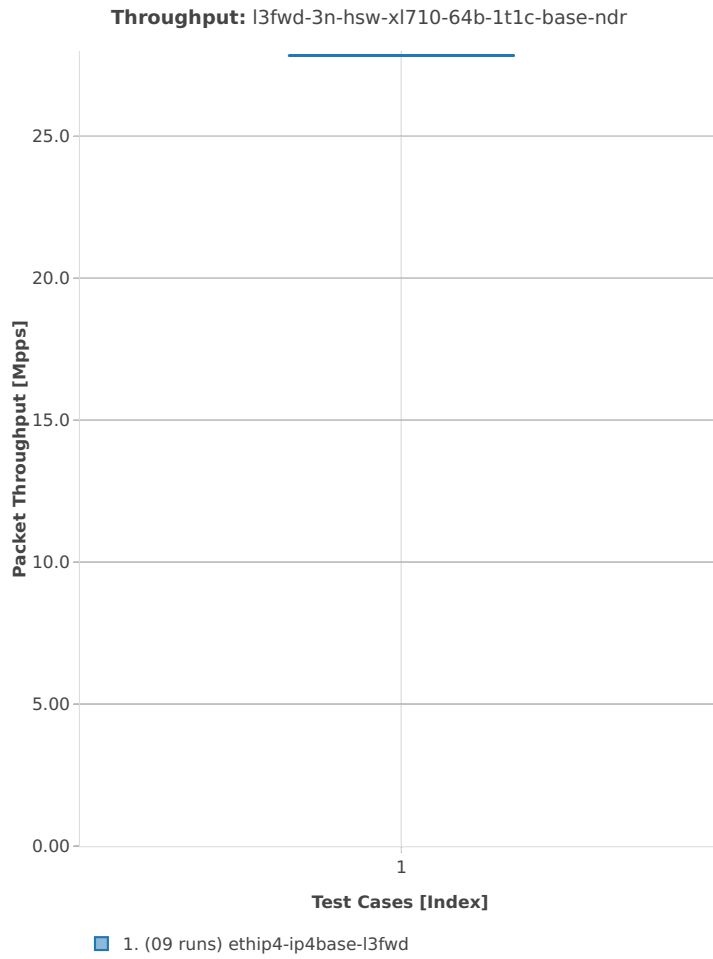

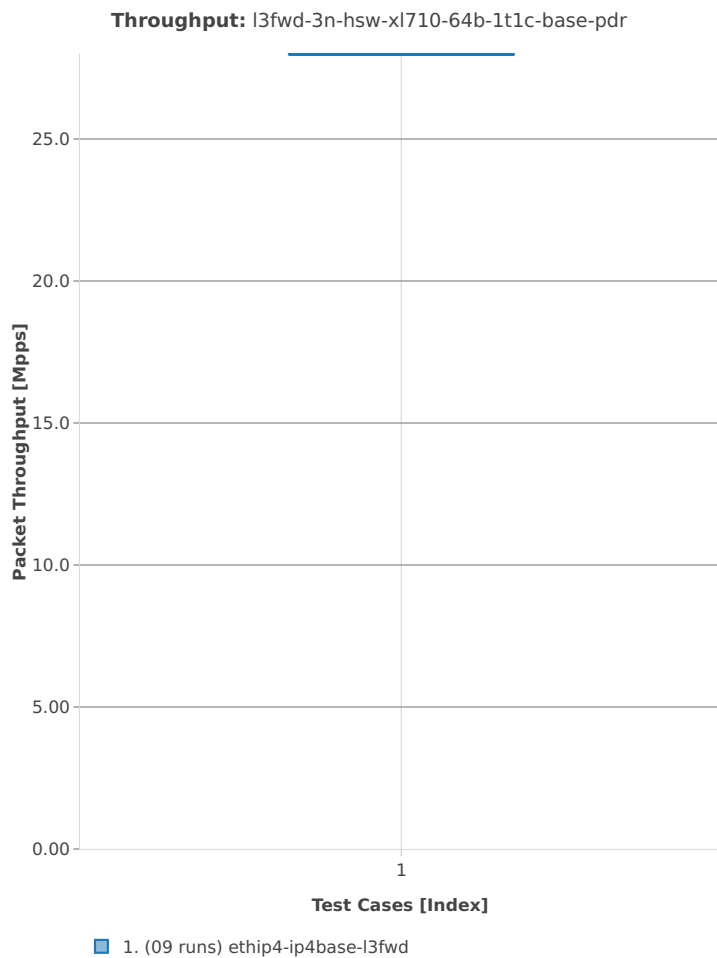

64b-2t2c-base

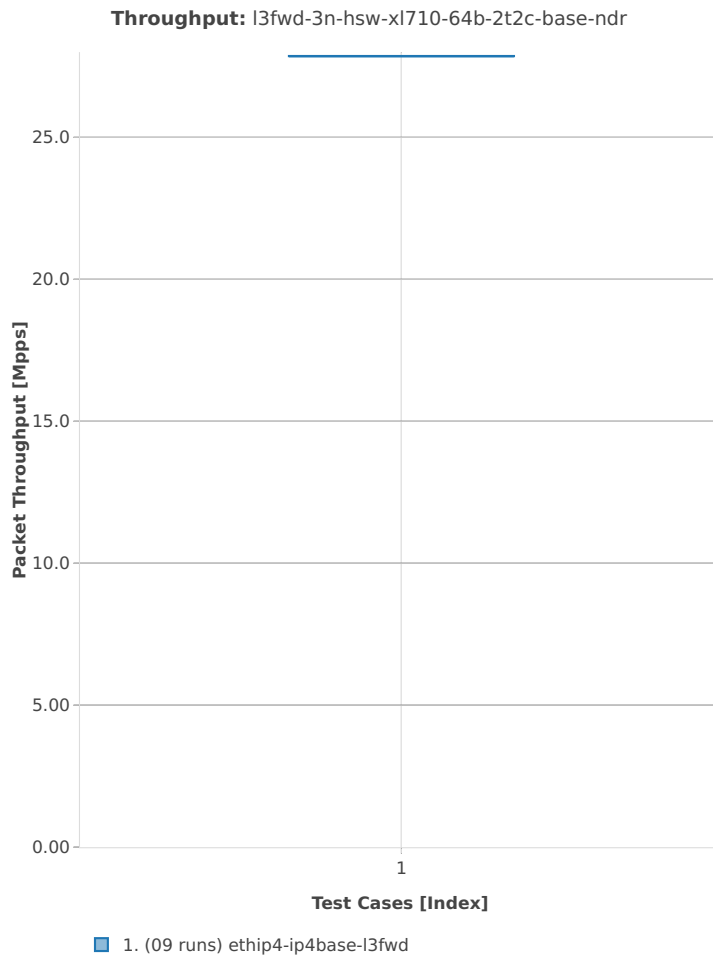



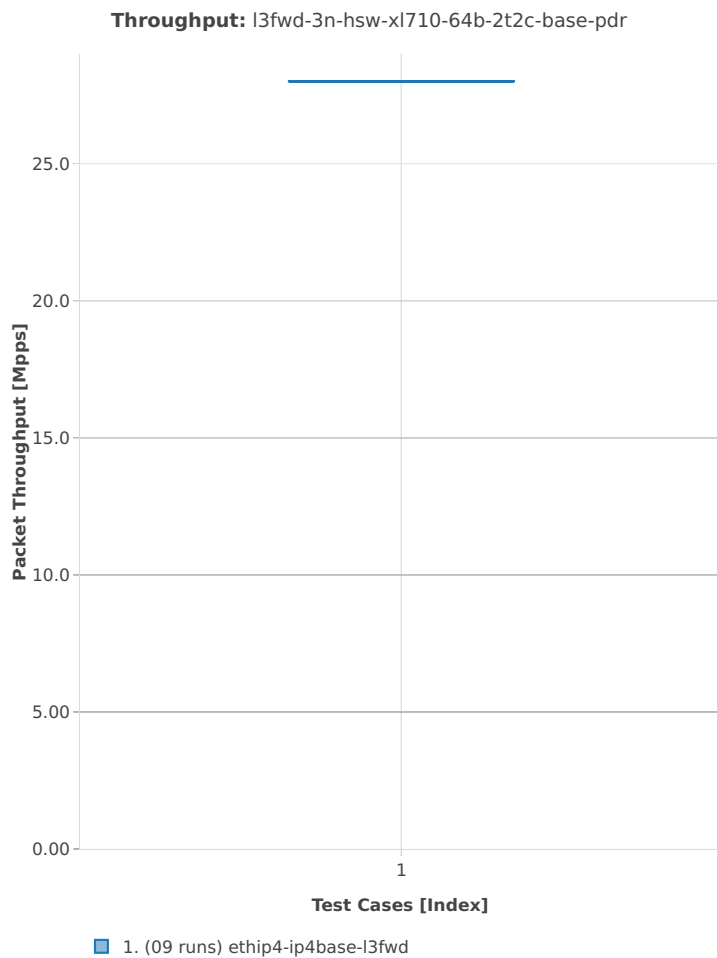

3n-skx-x710

64b-2t1c-base

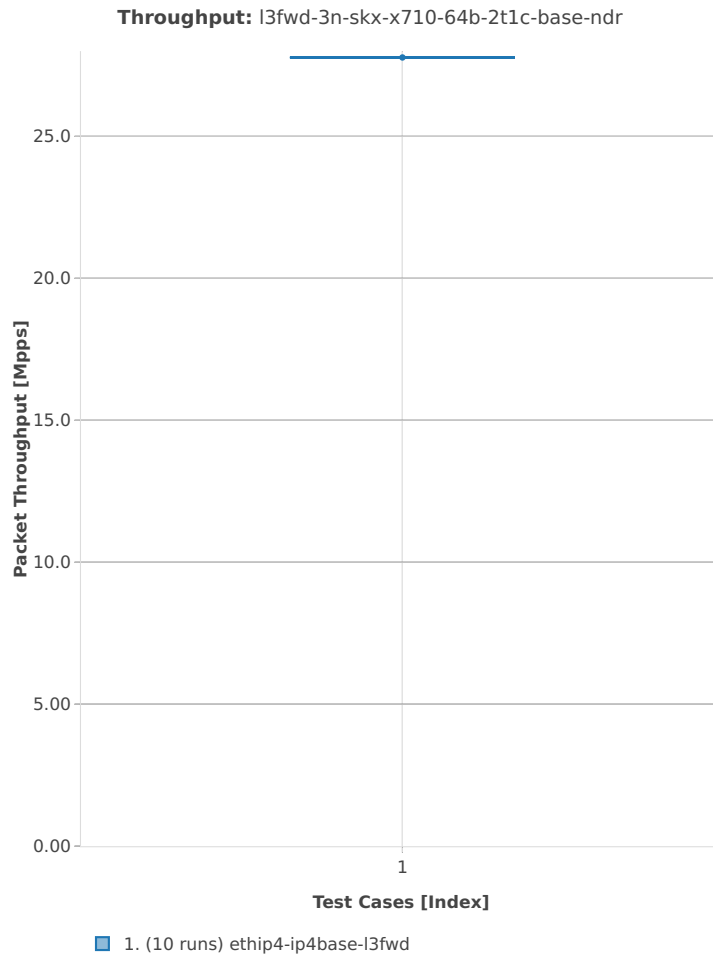

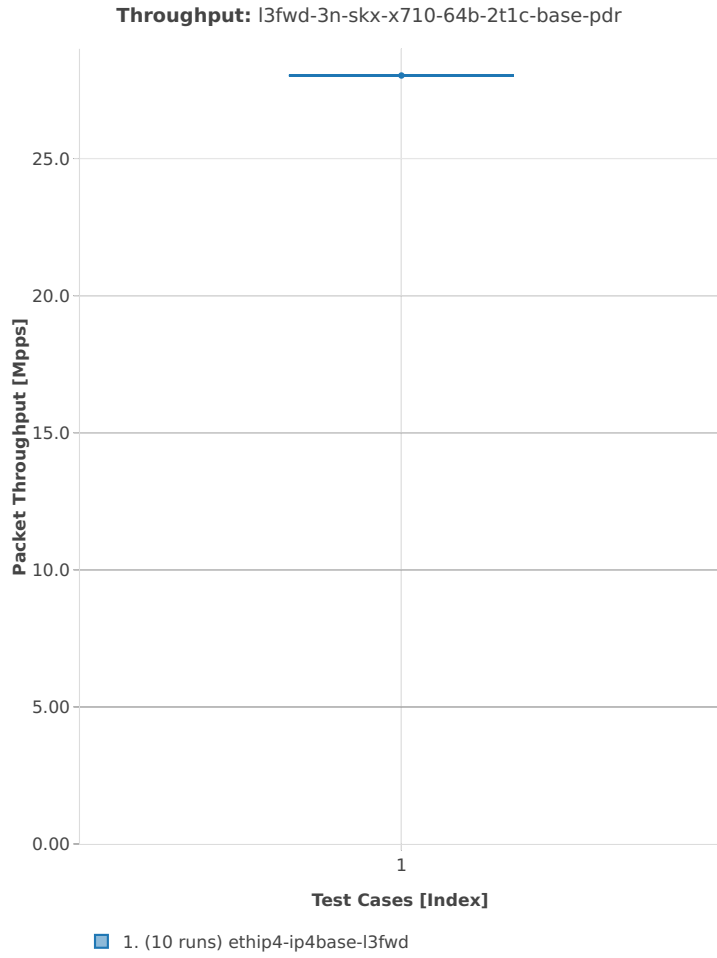

64b-4t2c-base

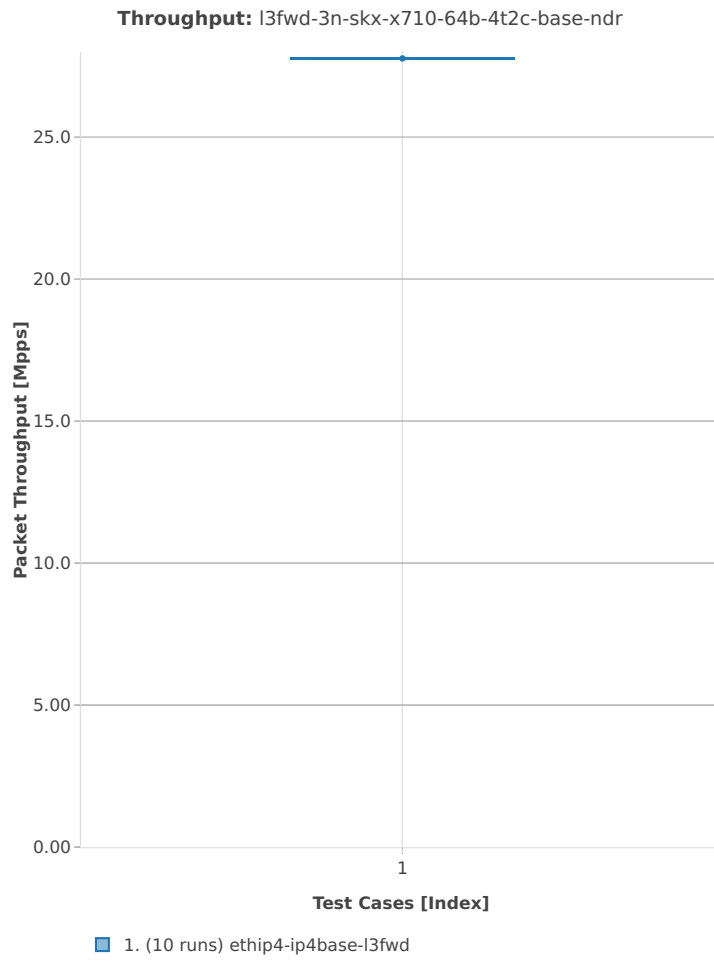

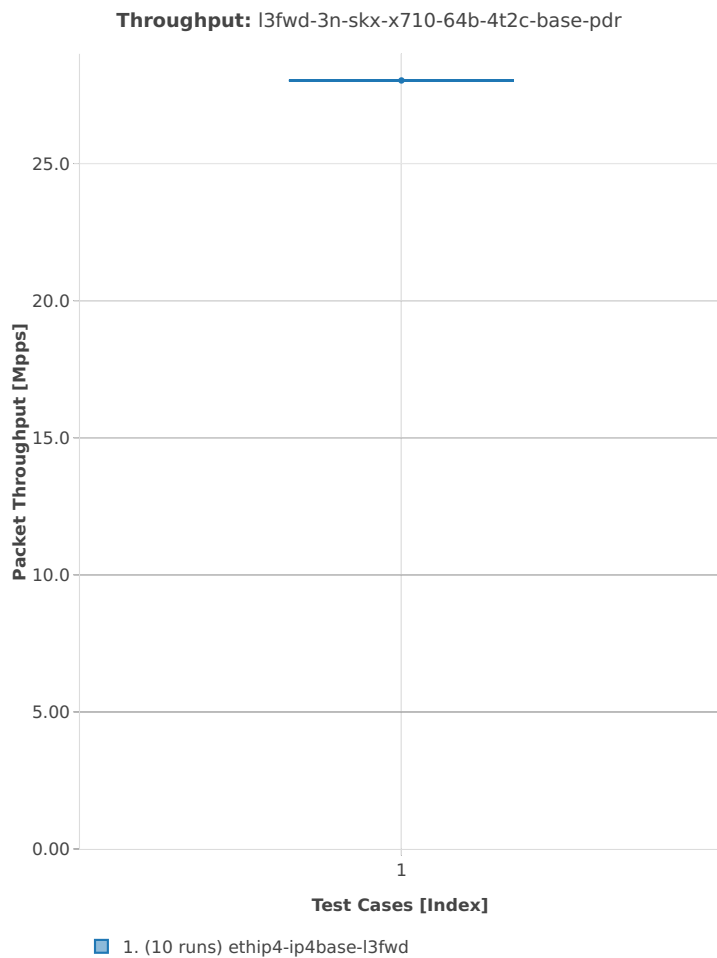

3n-skx-xxv710

64b-2t1c-base

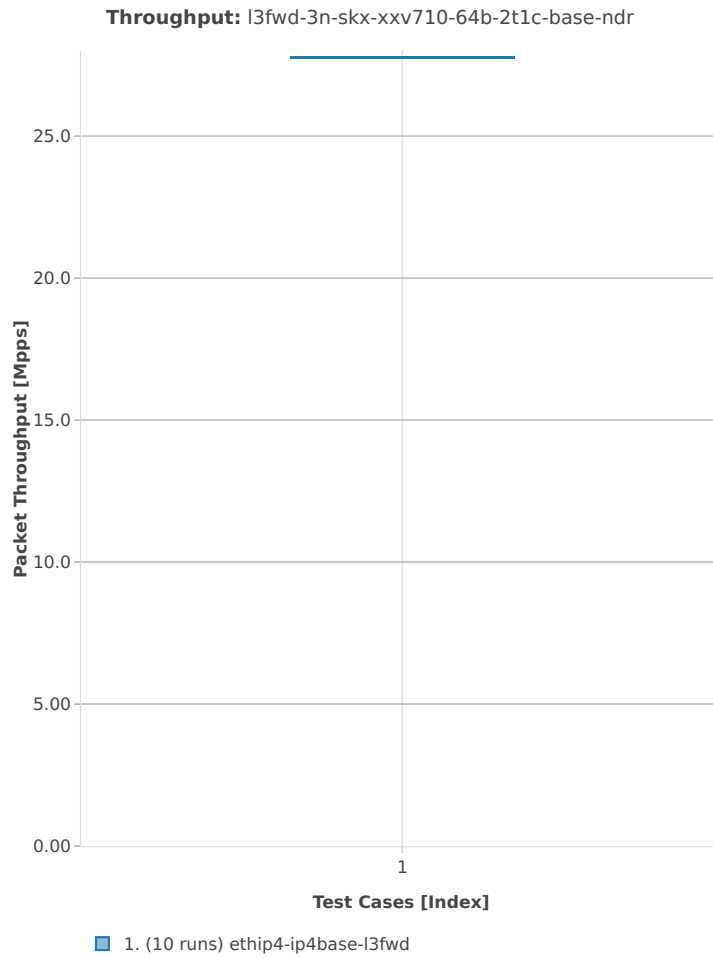

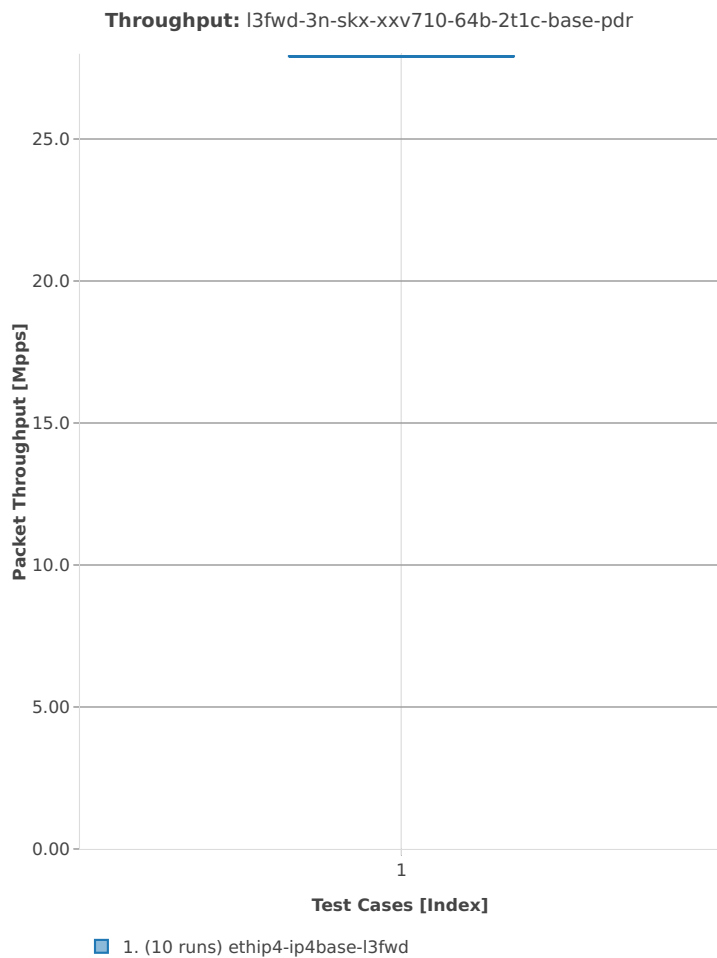

## 64b-4t2c-base

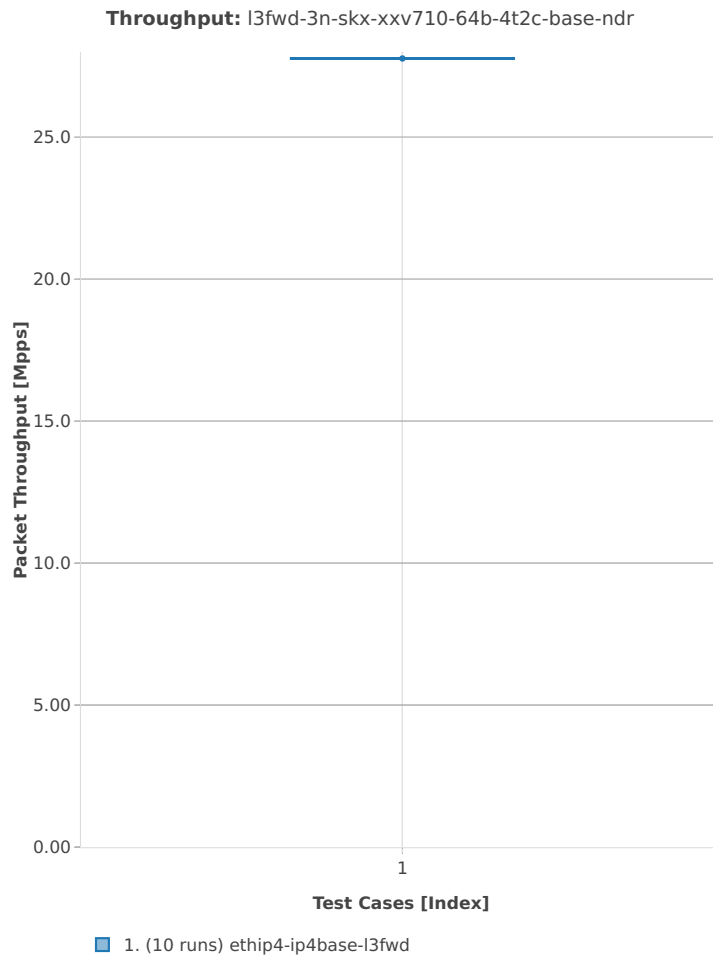



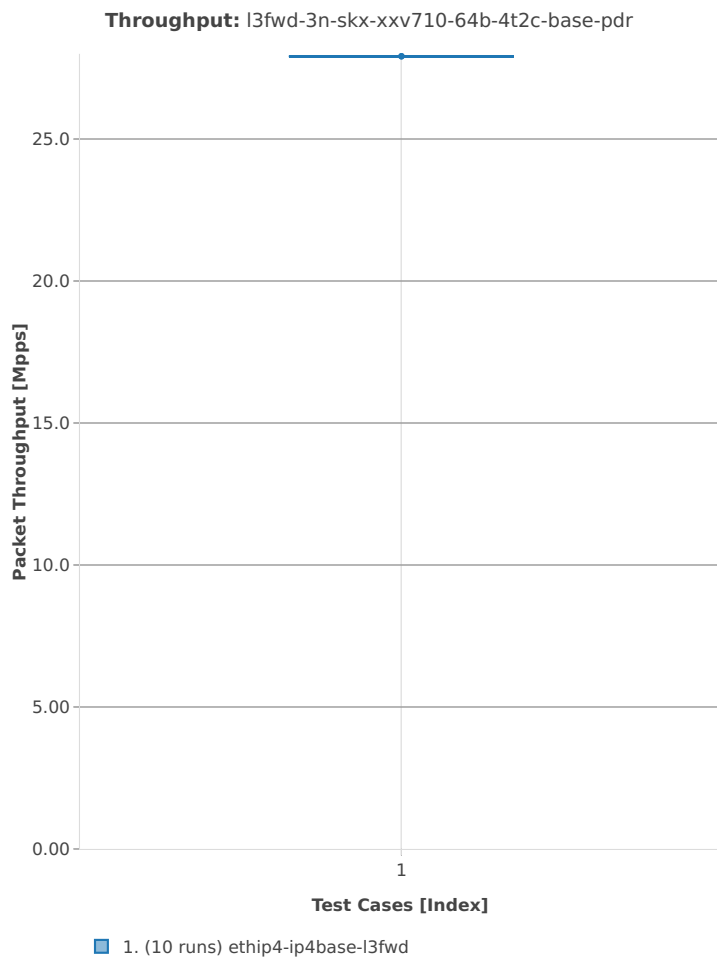

2n-skx-x710

64b-2t1c-base

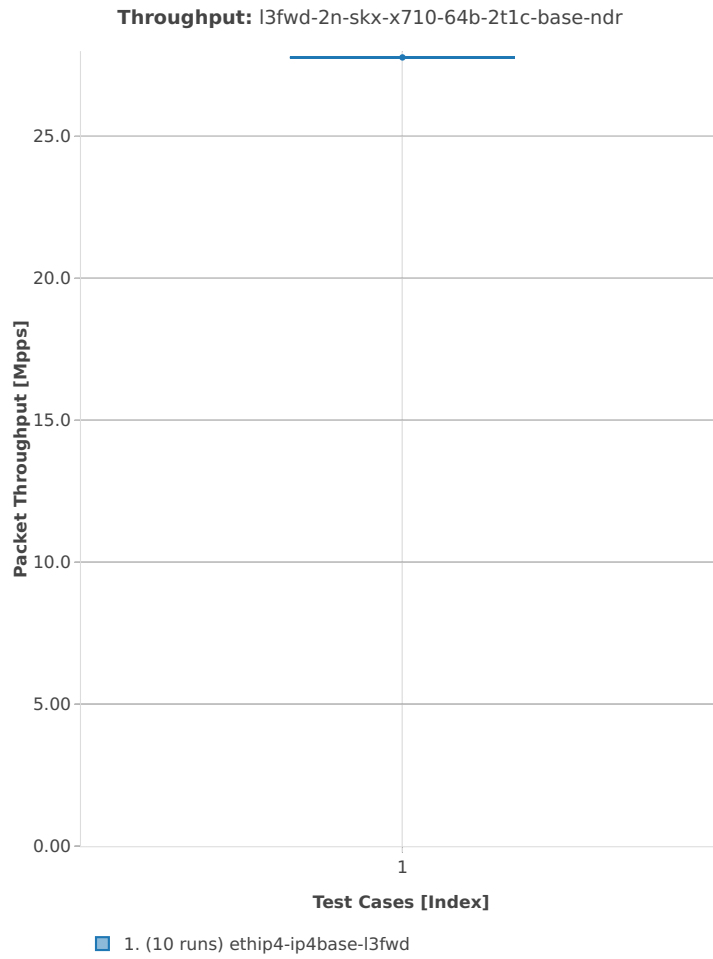

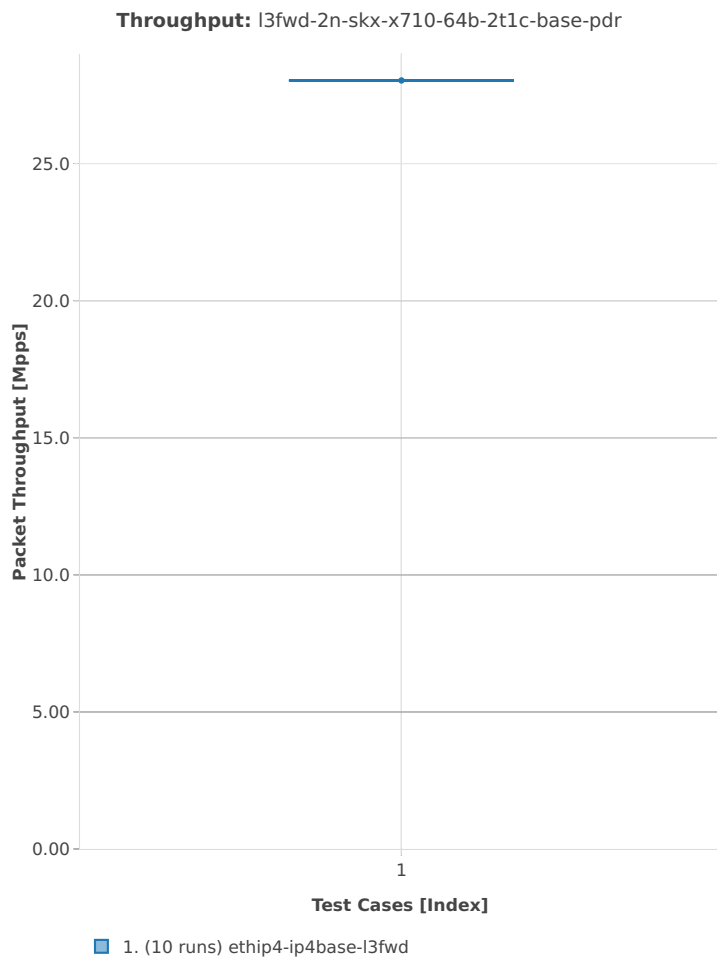

## 64b-4t2c-base

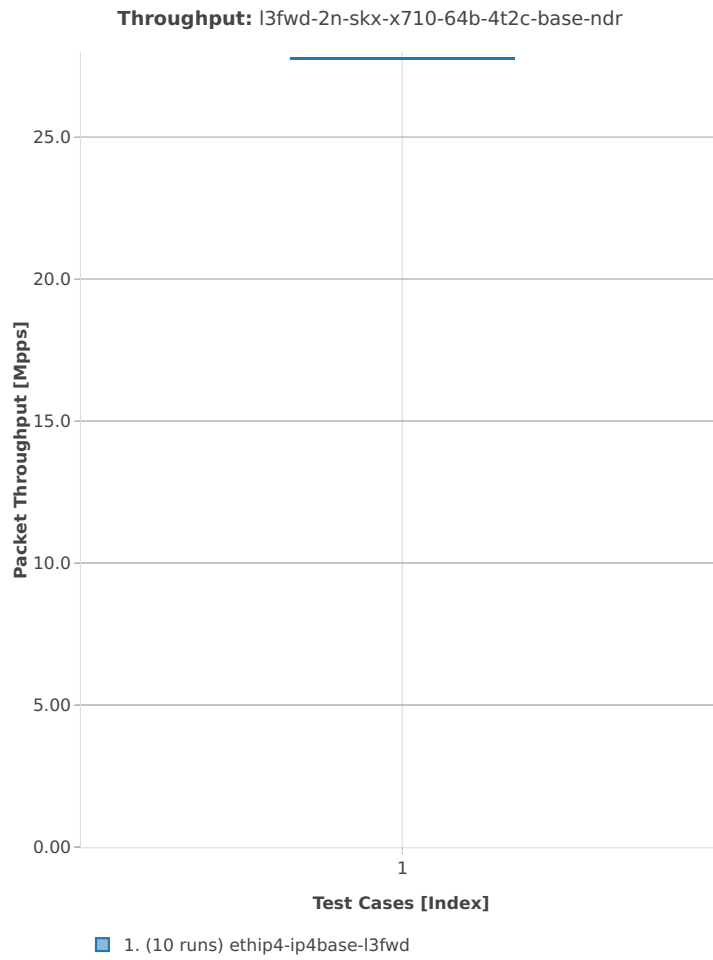

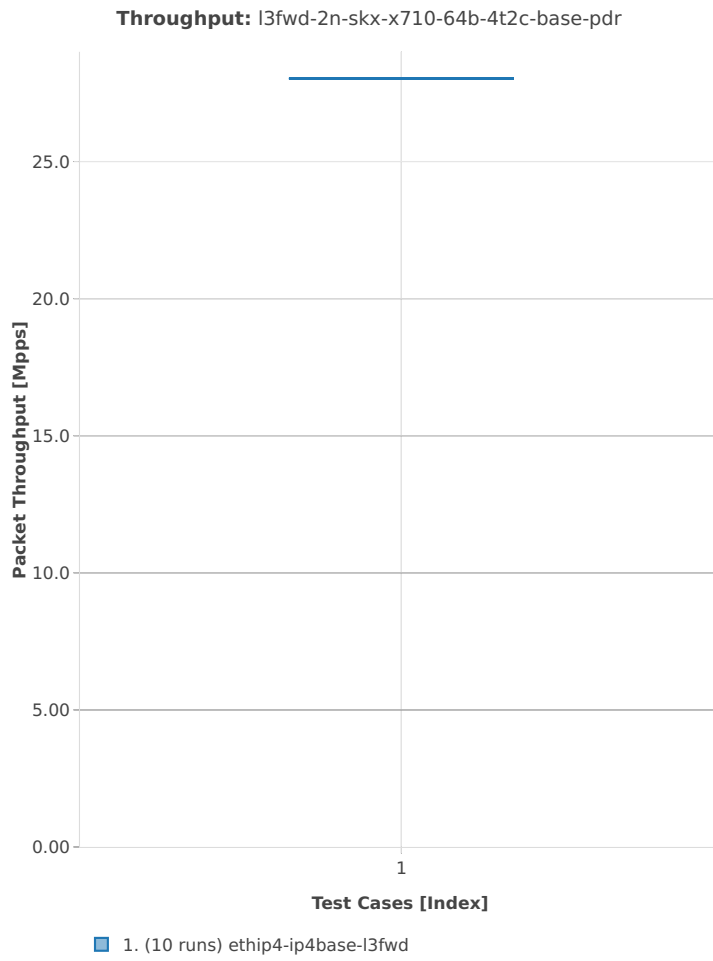

2n-skx-xxv710

64b-2t1c-base

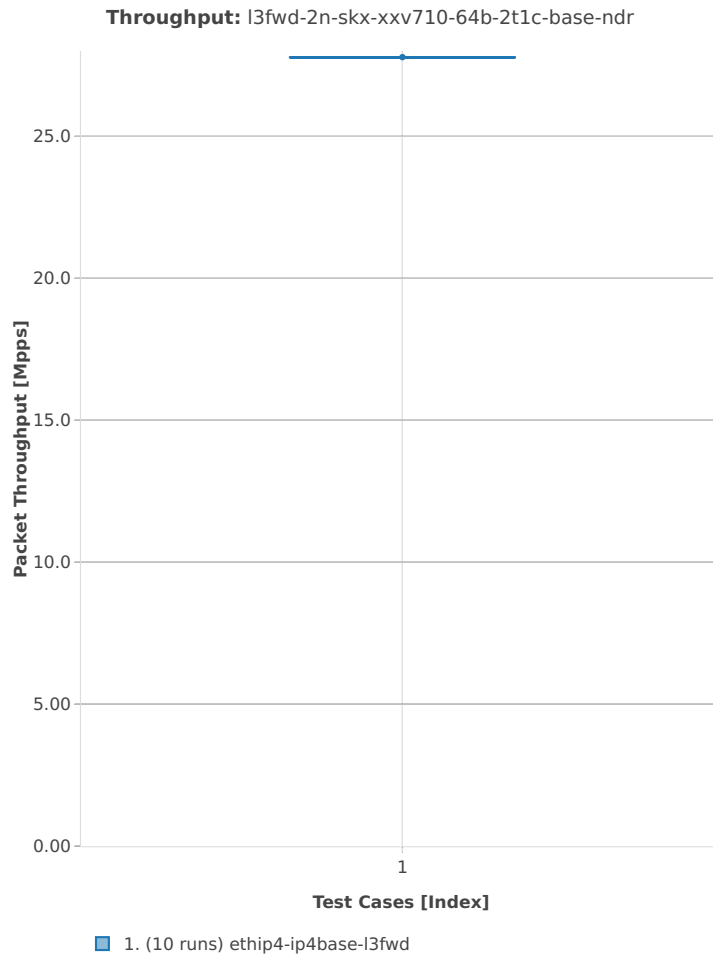

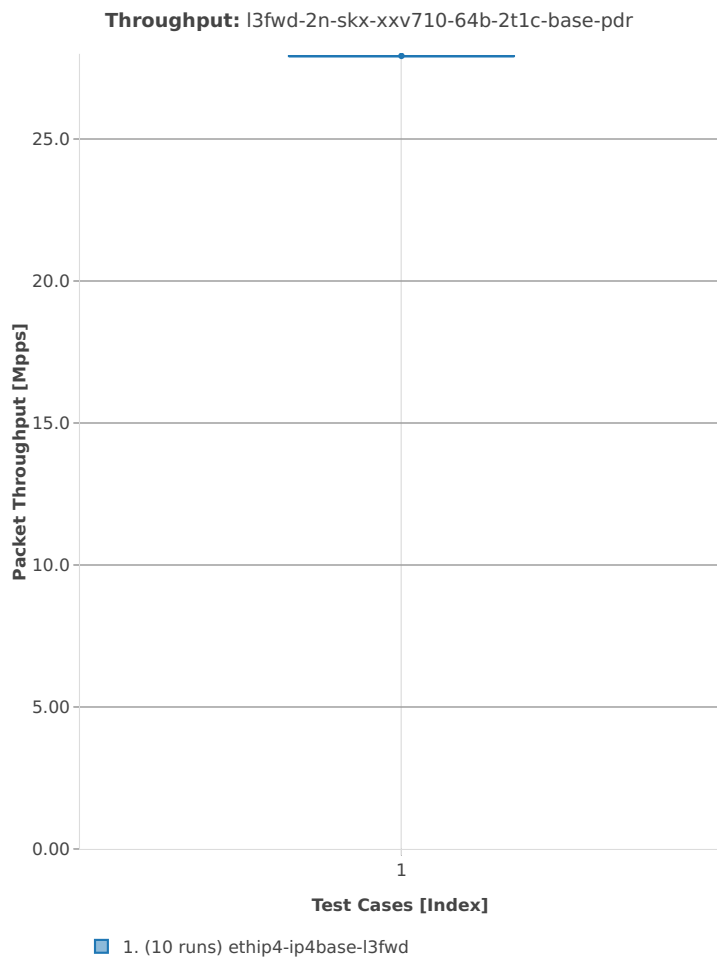

64b-4t2c-base

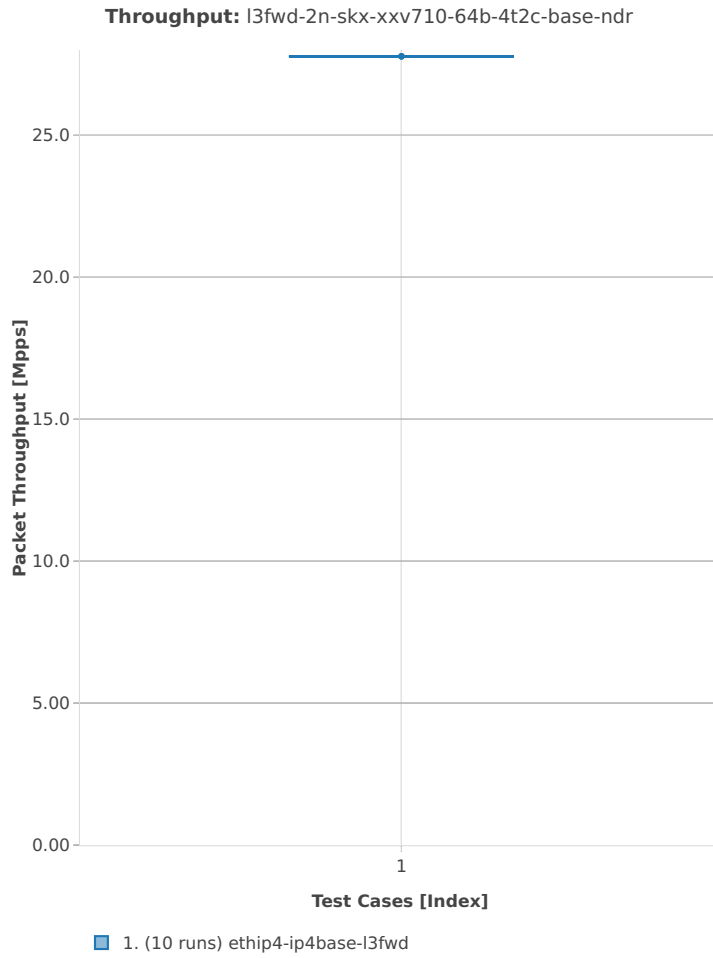



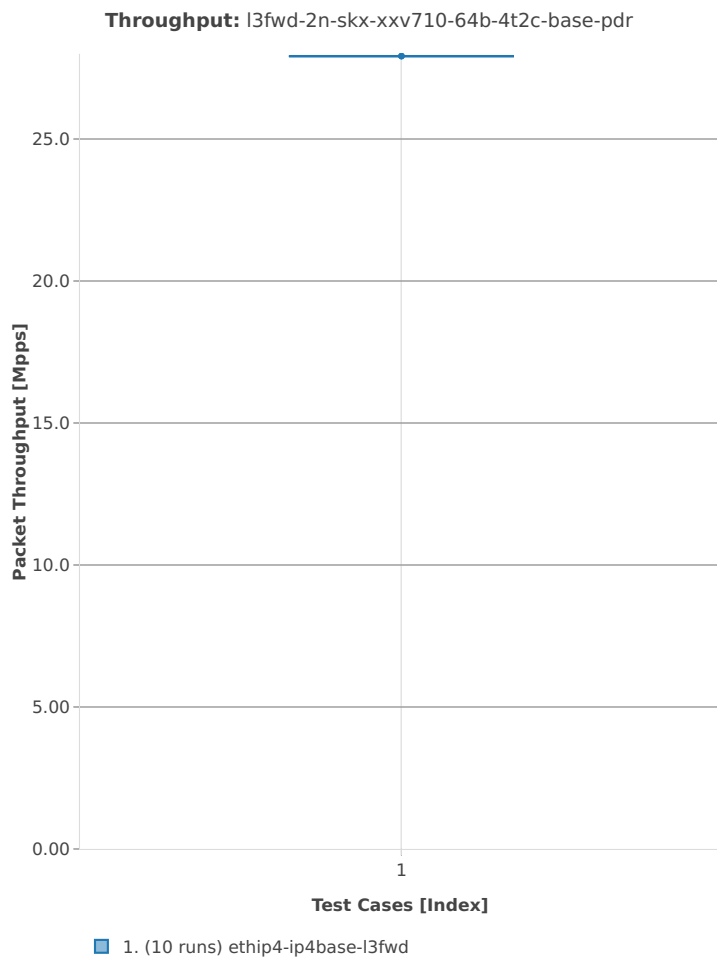

## 3.4 Packet Latency

Latency results are generated from a single execution of NDR discovery test across physical testbeds hosted LF FD.io labs: 3n-hsw, 2n-skx, 2n-skx. Box plots are used to show the Minimum, Median and Maximum packet latency per test.

Additional information about graph data:

1. **Graph Title:** describes tested packet path, testbed topology, processor model, NIC model, packet size, number of cores and threads used by data plane workers and indication of DUT configuration.
2. **X-axis Labels:** indices of individual test suites as listed in Graph Legend and direction of latency flow:
  - West-to-East: TGint1-to-SUT1-to-SUT2-to-TGint2.
  - East-to-West: TGint2-to-SUT2-to-SUT1-to-TGint1.
3. **Y-axis Labels:** measured packet latency values in [uSec].
4. **Graph Legend:** lists X-axis indices with associated CSIT test suites executed to generate graphed test results.
5. **Hover Information:** lists number of runs executed, specific test substring, packet flow direction, maximal, mean and minimal values of measured latencies.

---

**Note:** Test results have been generated by [FD.io test executor dpdk performance job 3n-hsw<sup>135</sup>](#), [FD.io test executor dpdk performance job 3n-skx<sup>136</sup>](#) and [FD.io test executor dpdk performance job 2n-skx<sup>137</sup>](#) with RF result files csit-dpdk-perf-1901-\*.zip [archived here](#).

---

<sup>135</sup> <https://jenkins.fd.io/view/csit/job/csit-dpdk-perf-verify-1901-3n-hsw>

<sup>136</sup> <https://jenkins.fd.io/view/csit/job/csit-dpdk-perf-verify-1901-3n-skx>

<sup>137</sup> <https://jenkins.fd.io/view/csit/job/csit-dpdk-perf-verify-1901-2n-skx>

### 3.4.1 Testpmd

This section includes summary graphs of Testpmd Phy-to-Phy packet latency with L2 Ethernet Interface Loop measured at 100% of discovered NDR throughput rate. Latency is reported for Testpmd running in multiple configurations of Testpmd pmd thread(s), a.k.a. Testpmd data plane thread(s), and their physical CPU core(s) placement.

CSIT source code for the test cases used for plots can be found in [CSIT git repository](#)<sup>138</sup>.

---

<sup>138</sup> <https://git.fd.io/csit/tree/tests/dpdk/perf?h=rls1901>

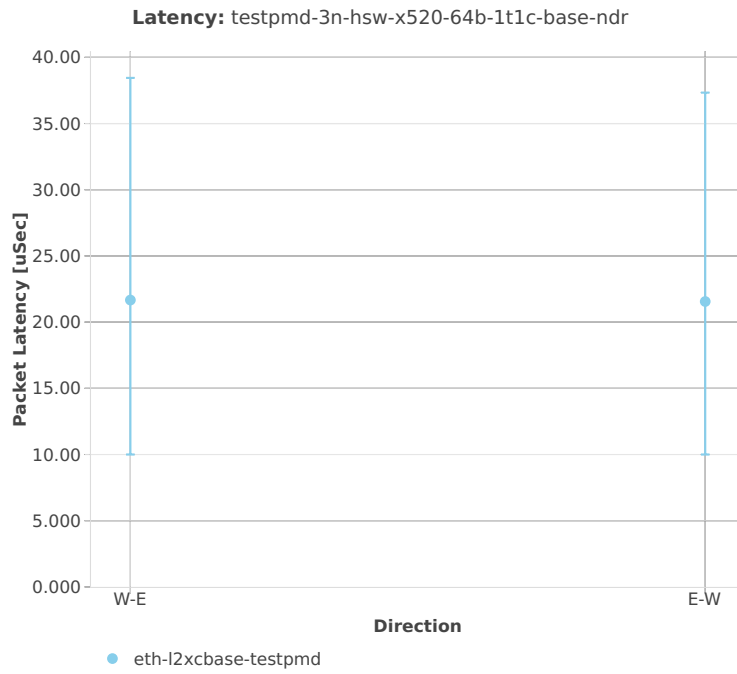
**3n-hsw-x520****64b-1t1c-base**

64b-2t2c-base

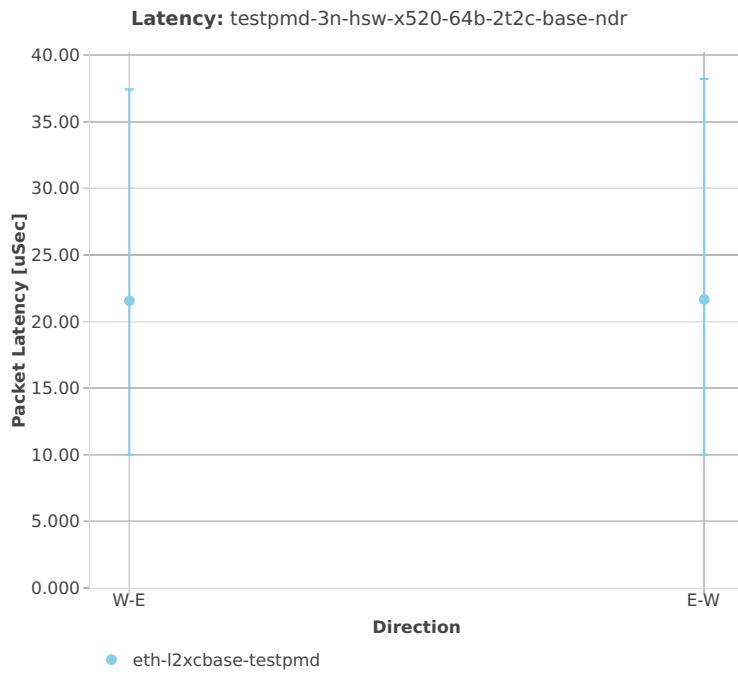

3n-hsw-x710

64b-1t1c-base

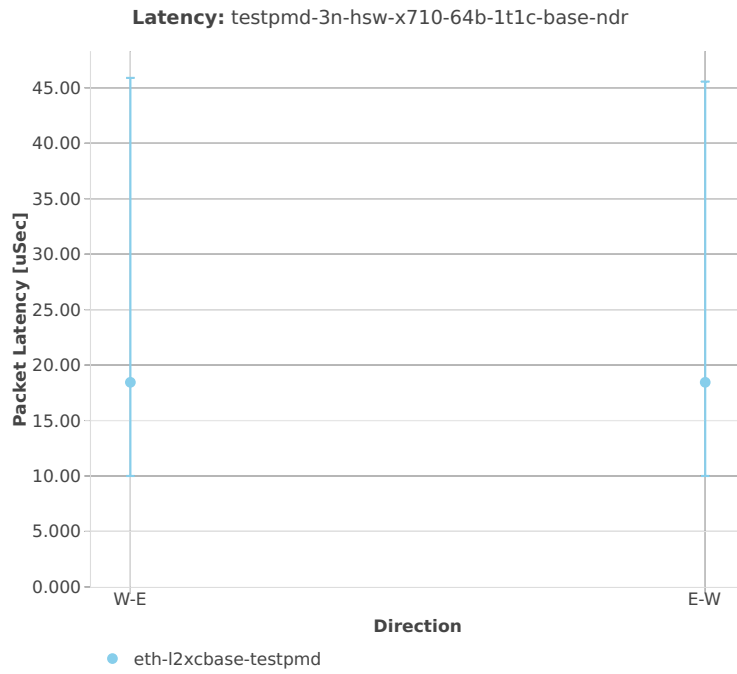

64b-2t2c-base

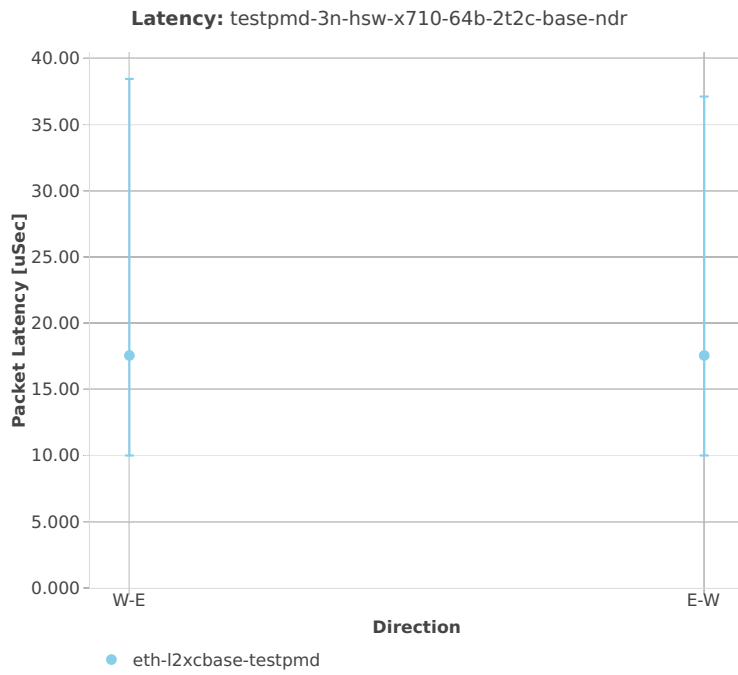

3n-hsw-xl710

64b-1t1c-base

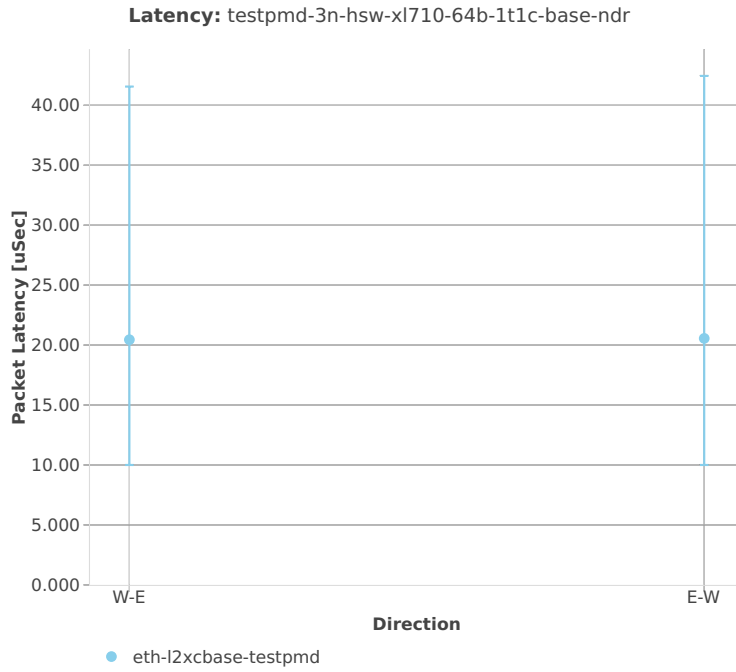



64b-2t2c-base

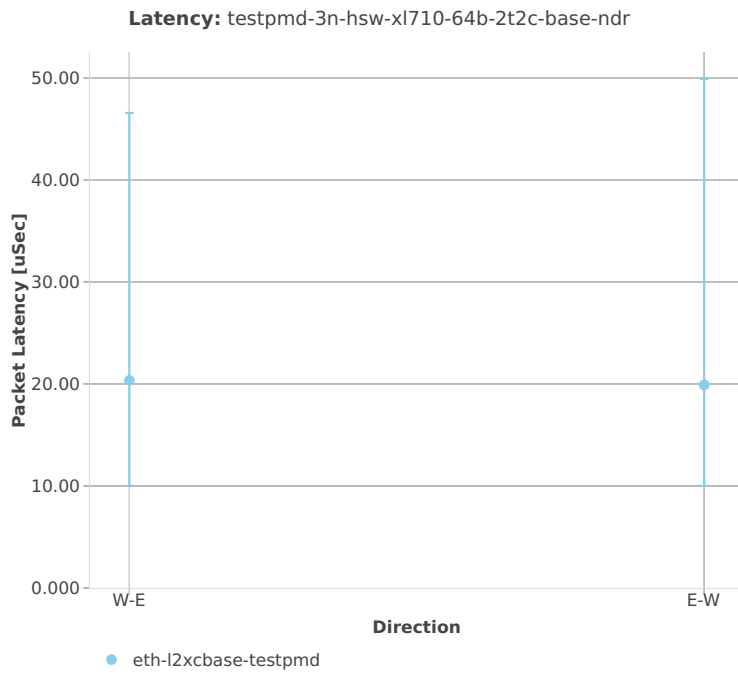

3n-skx-x710

64b-2t1c-base

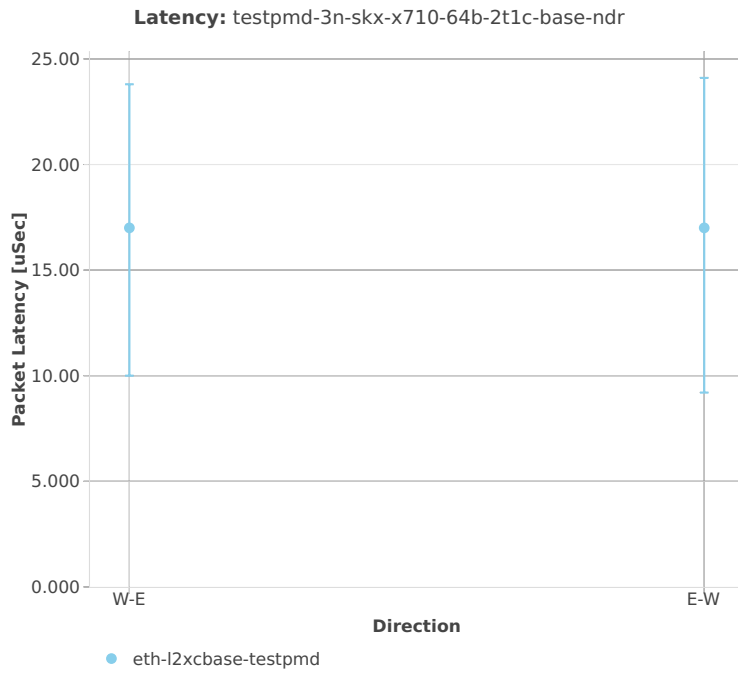

### 64b-4t2c-base

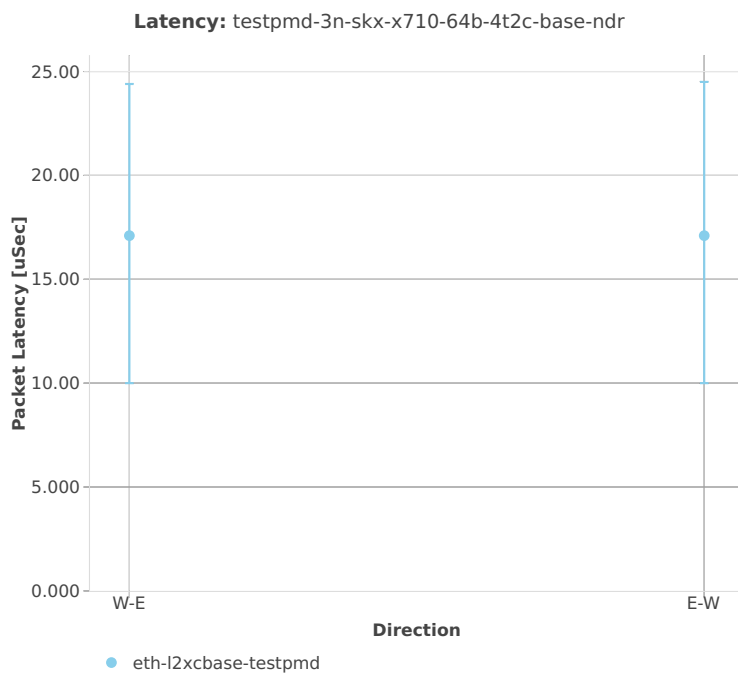

3n-skx-xxv710

64b-2t1c-base

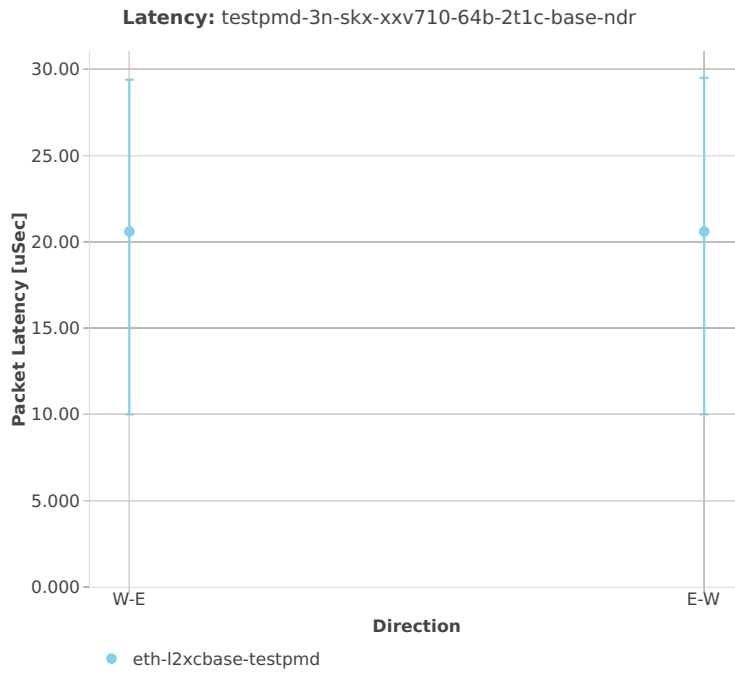

64b-4t2c-base

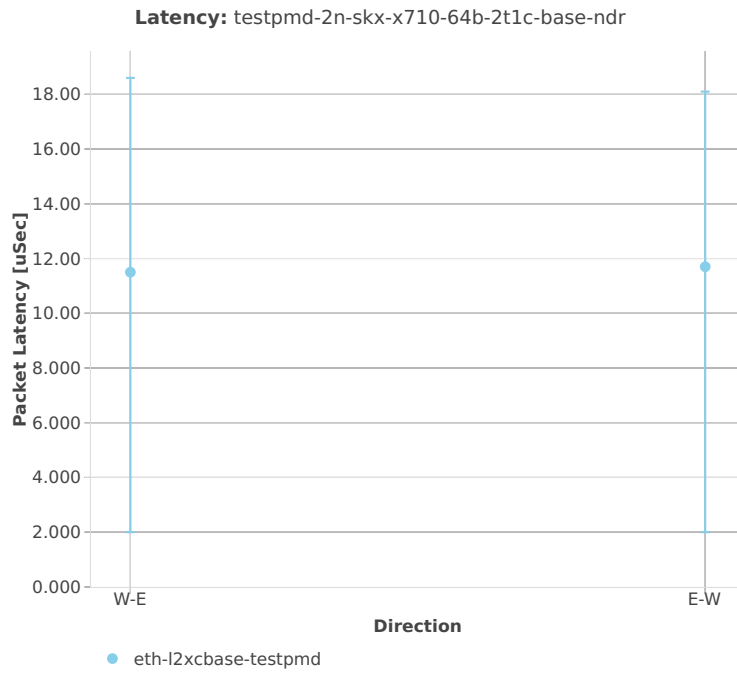

**2n-skx-x710****64b-2t1c-base**

64b-4t2c-base

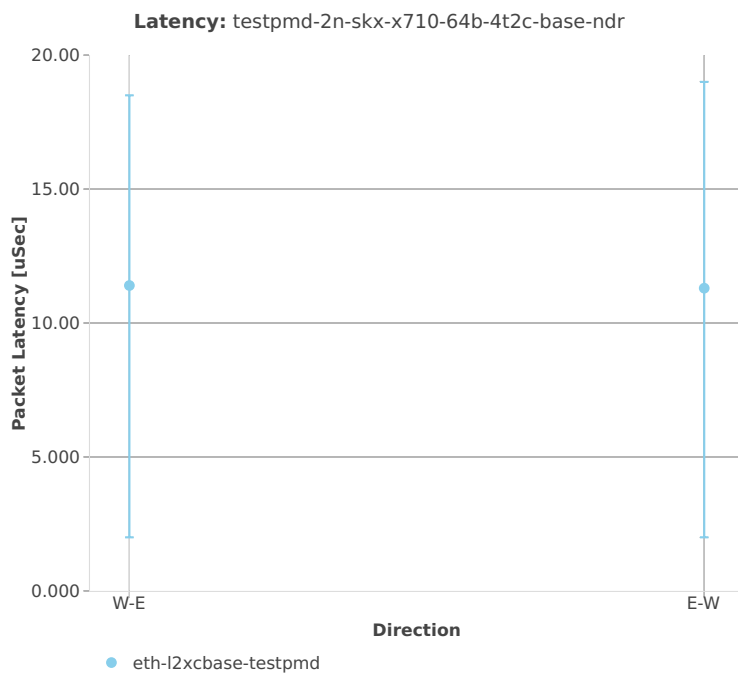

2n-skx-xxv710

64b-2t1c-base

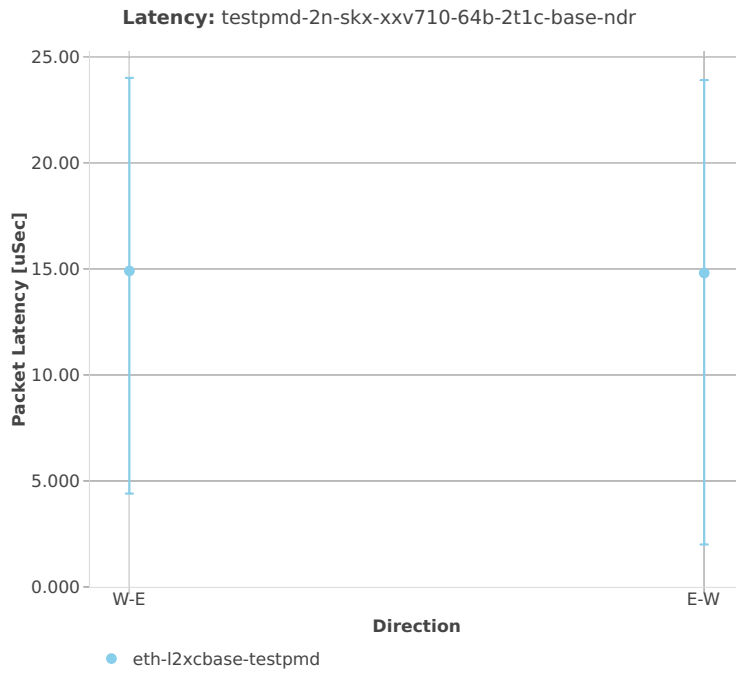



64b-4t2c-base

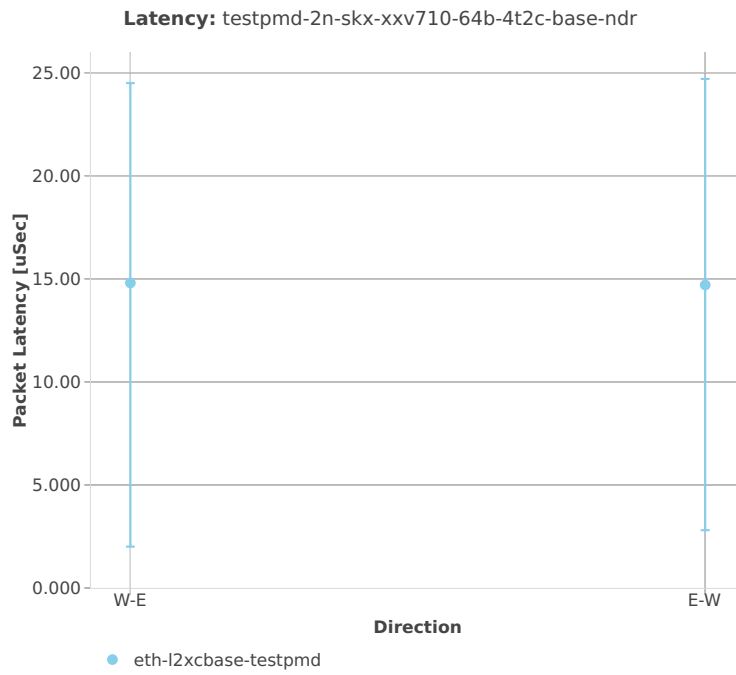

### 3.4.2 L3fwd

This section includes summary graphs of L3FWD Phy-to-Phy performance with packet routed forwarding measured at 100% of discovered NDR throughput rate. Latency is reported for L3FWD running in multiple configurations of L3FWD pmd thread(s), a.k.a. L3FWD data plane thread(s), and their physical CPU core(s) placement.

CSIT source code for the test cases used for plots can be found in [CSIT git repository](#)<sup>139</sup>.

---

<sup>139</sup> <https://git.fd.io/csit/tree/tests/dpdk/perf?h=rls1901>

3n-hsw-x520

64b-1t1c-base

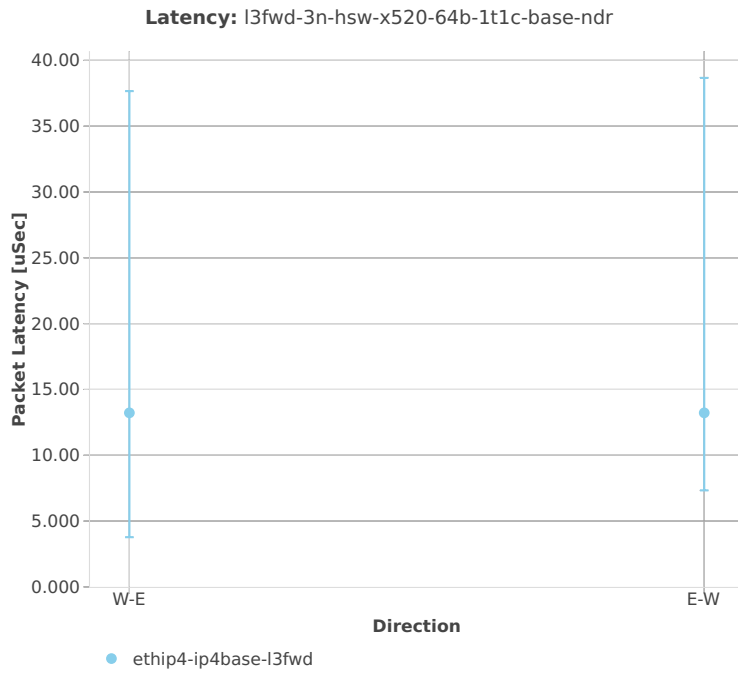

## 64b-2t2c-base

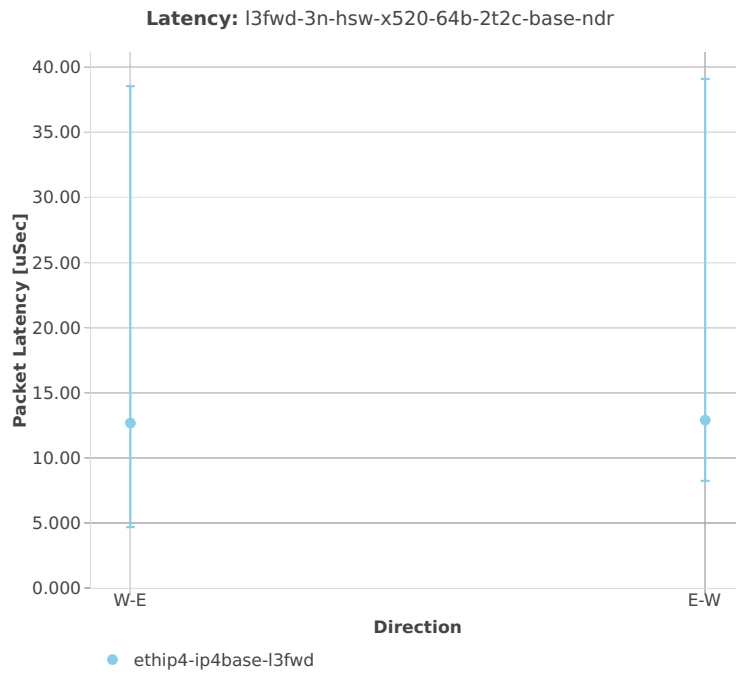

3n-hsw-x710

64b-1t1c-base

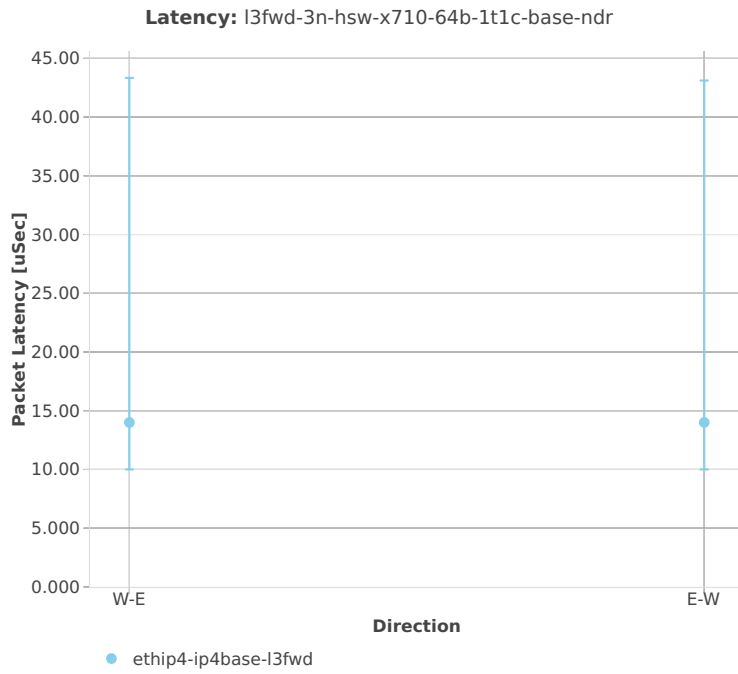

64b-2t2c-base

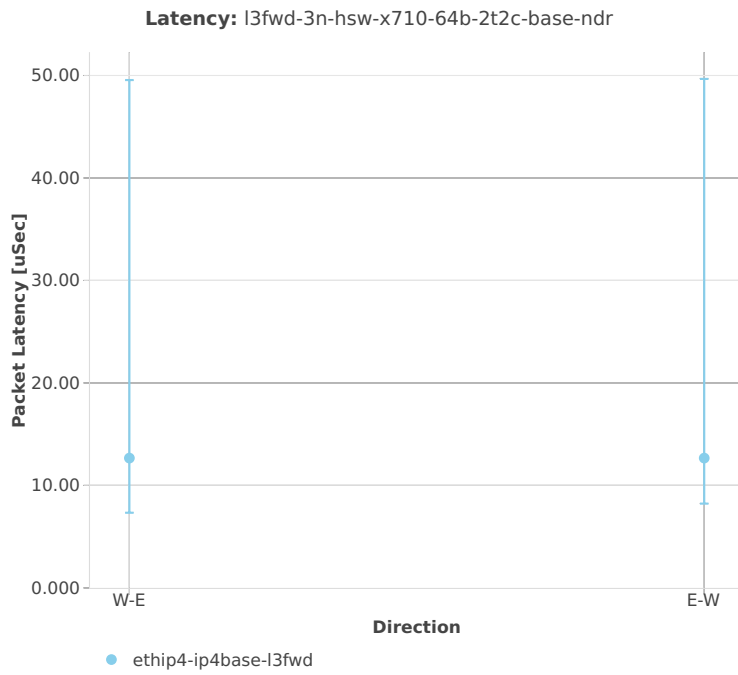

3n-hsw-xl710

64b-1t1c-base

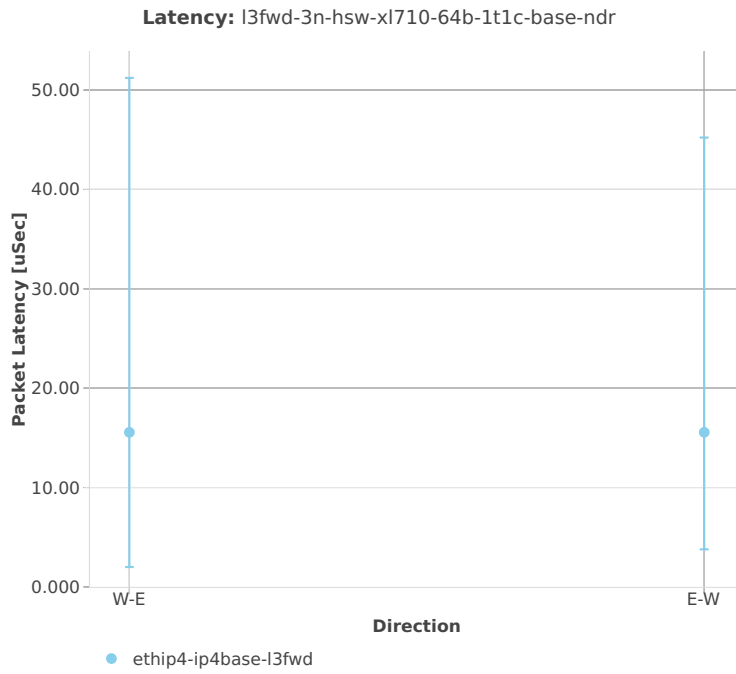

64b-2t2c-base

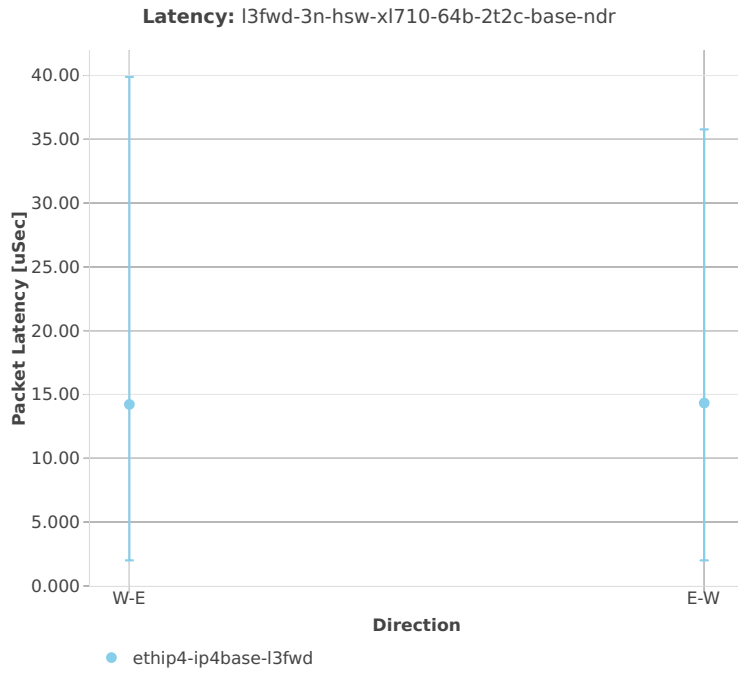



3n-skx-x710

64b-2t1c-base

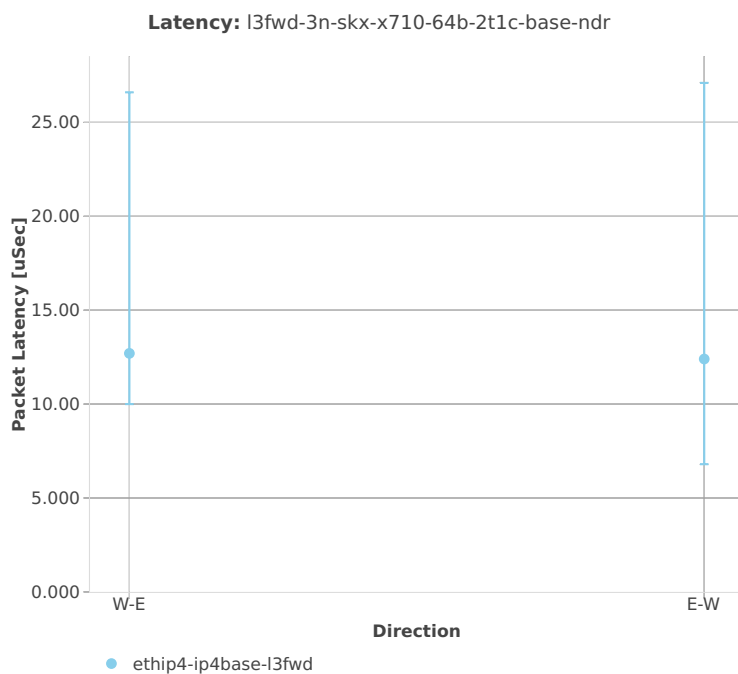

64b-4t2c-base

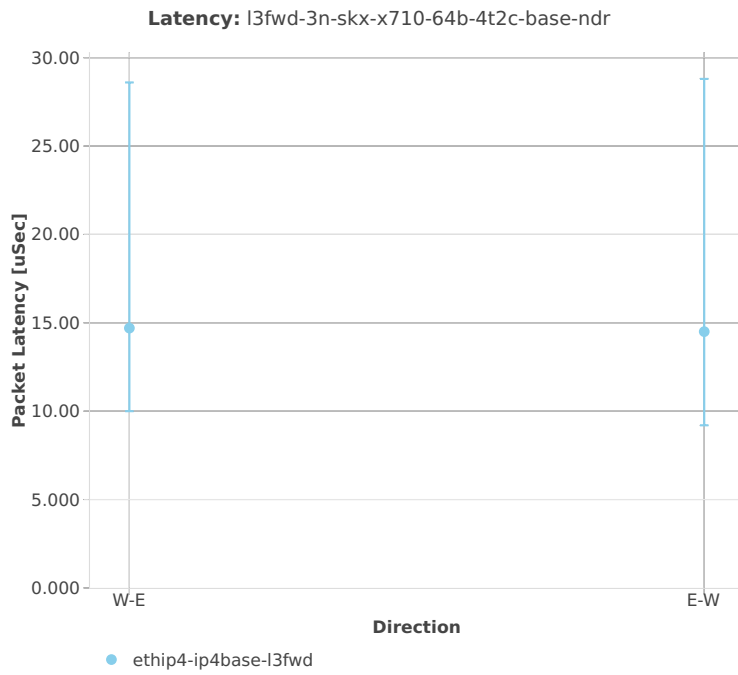

3n-skx-xxv710

64b-2t1c-base

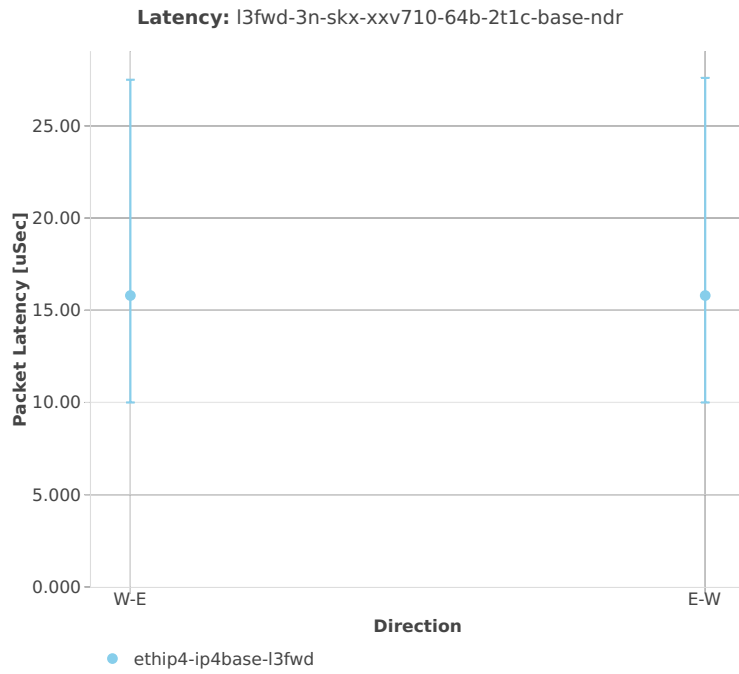

64b-4t2c-base

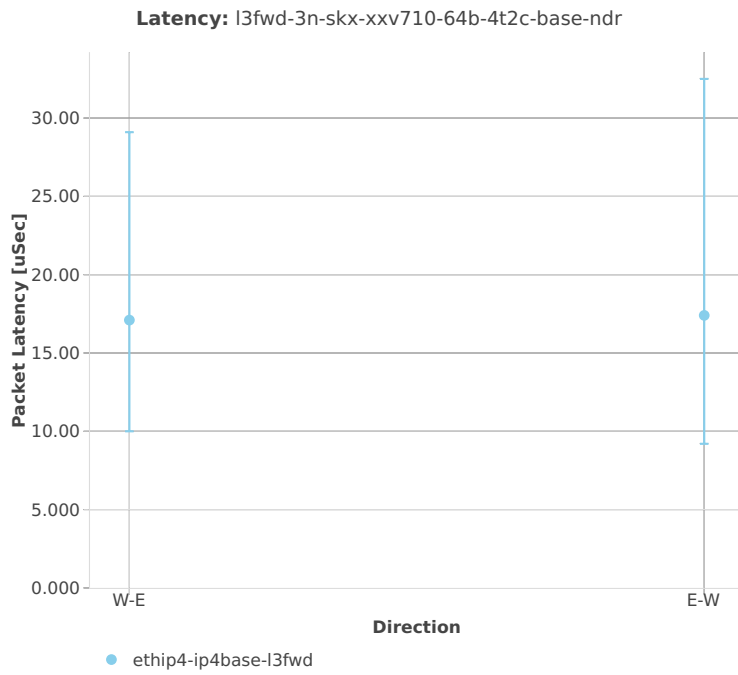

2n-skx-x710

64b-2t1c-base

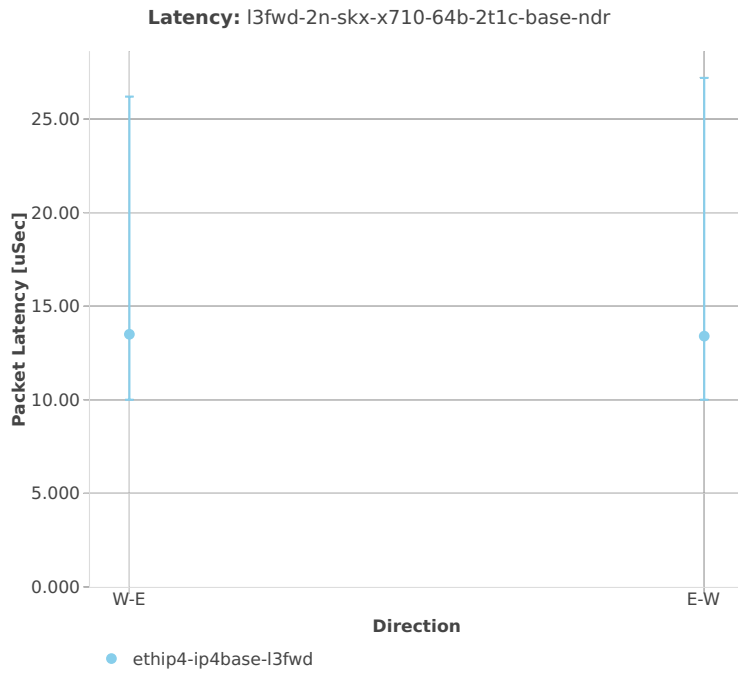

64b-4t2c-base

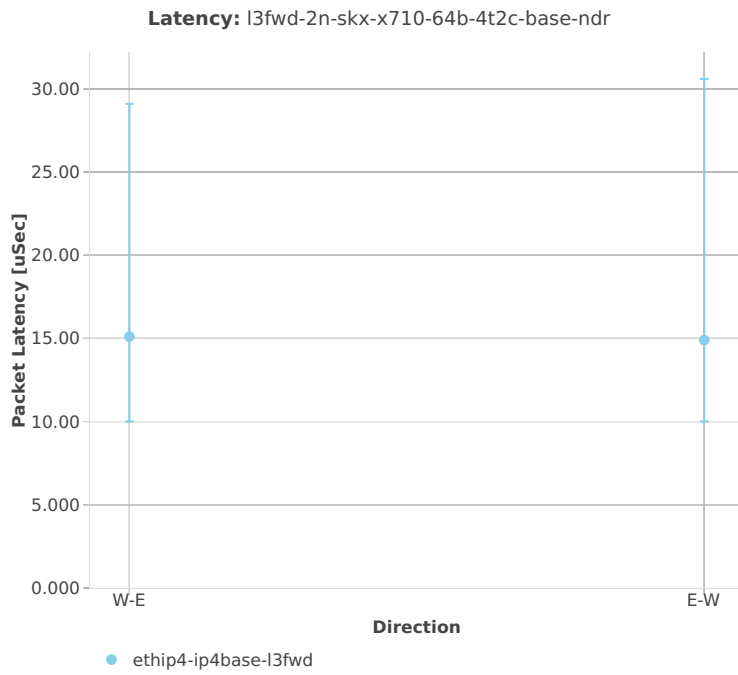

2n-skx-xxv710

64b-2t1c-base

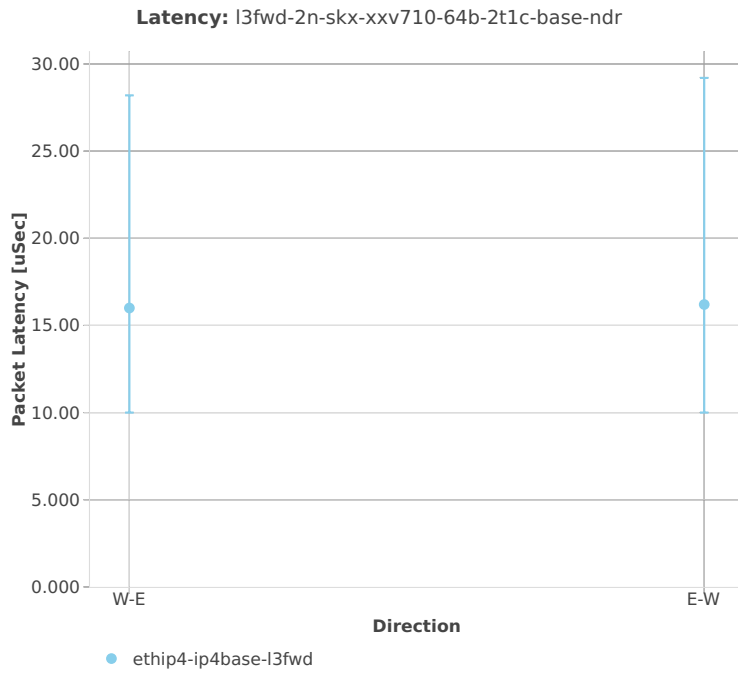

64b-4t2c-base

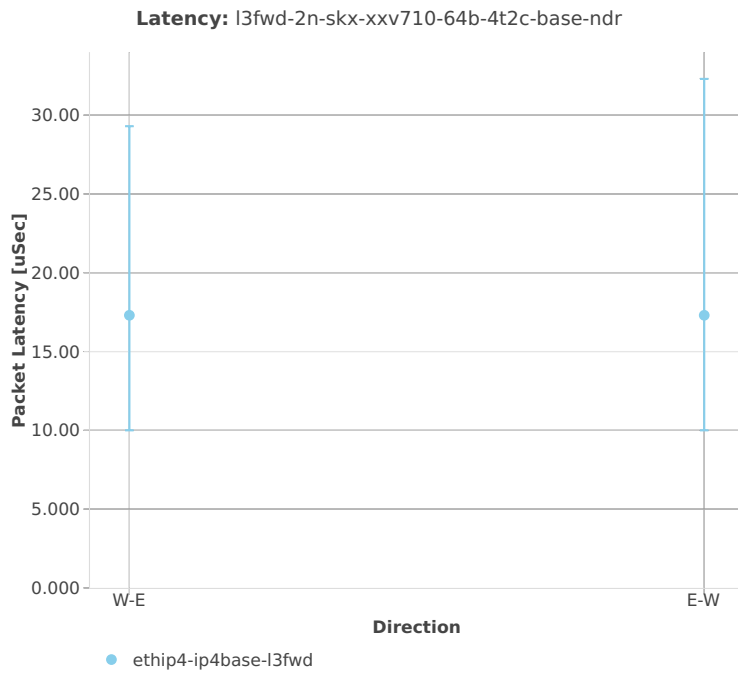



## 3.5 Comparisons

### 3.5.1 Current vs. Previous Release

Relative comparison of DPDK Testpmd and L3fwd packet throughput (NDR, PDR and MRR) between DPDK 18.11 and DPDK-18.02 (measured for CSIT-1901 and CSIT-1810 respectively) is calculated from results of tests running on 3-Node Intel Xeon Haswell testbeds (3n-hsw) in 1-core and 2-core configurations.

Listed mean and standard deviation values are computed based on a series of the same tests executed against respective DPDK releases to verify test results repeatability, with percentage change calculated for mean values.

---

**Note:** Test results have been generated by [FD.io test executor dpdk performance job 3n-hsw](#)<sup>140</sup> with RF result files csit-dpdk-perf-1901-\*.zip [archived here](#).

---

#### 3n-hsw

##### NDR Comparison

Comparison tables in ASCII and CSV formats:

- [ASCII 1t1c NDR comparison](#)
- [ASCII 2t2c NDR comparison](#)
- [CSV 1t1c NDR comparison](#)
- [CSV 2t2c NDR comparison](#)

##### PDR Comparison

Comparison tables in ASCII and CSV formats:

- [ASCII 1t1c PDR comparison](#)
- [ASCII 2t2c PDR comparison](#)
- [CSV 1t1c PDR comparison](#)
- [CSV 2t2c PDR comparison](#)

#### 3n-skx

##### NDR Comparison

Comparison tables in ASCII and CSV formats:

- [ASCII 2t1c NDR comparison](#)
- [ASCII 4t1c NDR comparison](#)
- [CSV 2t1c NDR comparison](#)
- [CSV 4t1c NDR comparison](#)

---

<sup>140</sup> <https://jenkins.fd.io/view/csit/job/csit-dpdk-perf-verify-1901-3n-hsw>

## PDR Comparison

Comparison tables in ASCII and CSV formats:

- [ASCII 2t1c PDR comparison](#)
- [ASCII 4t1c PDR comparison](#)
- [CSV 2t1c PDR comparison](#)
- [CSV 4t1c PDR comparison](#)

## 2n-skx

### NDR Comparison

Comparison tables in ASCII and CSV formats:

- [ASCII 2t1c NDR comparison](#)
- [ASCII 4t1c NDR comparison](#)
- [CSV 2t1c NDR comparison](#)
- [CSV 4t1c NDR comparison](#)

### PDR Comparison

Comparison tables in ASCII and CSV formats:

- [ASCII 2t1c PDR comparison](#)
- [ASCII 4t1c PDR comparison](#)
- [CSV 2t1c PDR comparison](#)
- [CSV 4t1c PDR comparison](#)

## 3.5.2 3n-Skx vs. 3n-Hsw Testbeds

Relative comparison of DPDK 18.11 Testpmd and L3fwd packet throughput (NDR, PDR and MRR) is calculated for the same tests executed on 3-Node Skylake (3n-skx) and 3-Node Haswell (3n-hsw) physical testbed types, in 1-core, 2-core and 4-core configurations.

---

**Note:** Test results have been generated by [FD.io test executor dpdk performance job 3n-hsw<sup>141</sup>](#) and [FD.io test executor dpdk performance job 3n-skx<sup>142</sup>](#) with RF result files csit-dpdk-perf-1901-\*.zip [archived here](#).

---

### NDR Comparison

Comparison tables in ASCII and CSV formats:

- [ASCII NDR comparison](#)
- [CSV NDR comparison](#)

<sup>141</sup> <https://jenkins.fd.io/view/csit/job/csit-dpdk-perf-verify-1901-3n-hsw>

<sup>142</sup> <https://jenkins.fd.io/view/csit/job/csit-dpdk-perf-verify-1901-3n-skx>

### PDR Comparison

Comparison tables in ASCII and CSV formats:

- [ASCII PDR comparison](#)
- [CSV PDR comparison](#)

### 3.5.3 3n-Skx vs. 2n-Skx Testbeds

Relative comparison of DPDK 18.11 Testpmd and L3fwd packet throughput (NDR, PDR and MRR) is calculated for the same tests executed on 3-Node Skylake (3n-skx) and 2-Node Skylake (2n-skx) physical testbed types, in 1-core, 2-core and 4-core configurations.

---

**Note:** Test results have been generated by [FD.io test executor dpdk performance job 3n-skx<sup>143</sup>](#) and [FD.io test executor dpdk performance job 2n-skx<sup>144</sup>](#) with RF result files csit-dpdk-perf-1901-\*.zip [archived here](#).

---

### NDR Comparison

Comparison tables in ASCII and CSV formats:

- [ASCII NDR comparison](#)
- [CSV NDR comparison](#)

### PDR Comparison

Comparison tables in ASCII and CSV formats:

- [ASCII PDR comparison](#)
- [CSV PDR comparison](#)

## 3.6 Throughput Trending

In addition to reporting throughput comparison between DPDK releases, CSIT provides regular performance trending for DPDK release branches:

1. [Performance Dashboard<sup>145</sup>](#): per DPDK test case throughput trend, trend compliance and summary of detected anomalies.
2. [Trending Methodology<sup>146</sup>](#): throughput test metrics, trend calculations and anomaly classification (progression, regression).
3. [DPDK Trendline Graphs<sup>147</sup>](#): weekly DPDK Testpmd and L3fwd MRR throughput measurements against the trendline with anomaly highlights and associated CSIT test jobs.

---

<sup>143</sup> <https://jenkins.fd.io/view/csit/job/csit-dpdk-perf-verify-1901-3n-skx>

<sup>144</sup> <https://jenkins.fd.io/view/csit/job/csit-dpdk-perf-verify-1901-2n-skx>

<sup>145</sup> <https://docs.fd.io/csit/master/trending/introduction/index.html>

<sup>146</sup> <https://docs.fd.io/csit/master/trending/methodology/index.html>

<sup>147</sup> <https://docs.fd.io/csit/master/trending/trending/dpdk.html>

## 3.7 Test Environment

### 3.7.1 Physical Testbeds

FD.io CSIT performance tests are executed in physical testbeds hosted by LF for FD.io project. Two physical testbed topology types are used:

- **3-Node Topology:** Consisting of two servers acting as SUTs (Systems Under Test) and one server as TG (Traffic Generator), all connected in ring topology.
- **2-Node Topology:** Consisting of one server acting as SUTs and one server as TG both connected in ring topology.

Tested SUT servers are based on a range of processors including Intel Xeon Haswell-SP, Intel Xeon Skylake-SP, Arm, Intel Atom. More detailed description is provided in *Physical Testbeds* (page 4). Tested logical topologies are described in *Logical Topologies* (page 31).

### 3.7.2 Server Specifications

Complete technical specifications of compute servers used in CSIT physical testbeds are maintained on FD.io wiki pages: [CSIT/Testbeds: Xeon Hsw, VIRL](#)<sup>148</sup> and [CSIT Testbeds: Xeon Skx, Arm, Atom](#)<sup>149</sup>.

### 3.7.3 Pre-Test Server Calibration

Number of SUT server sub-system runtime parameters have been identified as impacting data plane performance tests. Calibrating those parameters is part of FD.io CSIT pre-test activities, and includes measuring and reporting following:

1. System level core jitter – measure duration of core interrupts by Linux in clock cycles and how often interrupts happen. Using [CPU core jitter tool](#)<sup>150</sup>.
2. Memory bandwidth – measure bandwidth with [Intel MLC tool](#)<sup>151</sup>.
3. Memory latency – measure memory latency with Intel MLC tool.
4. Cache latency at all levels (L1, L2, and Last Level Cache) – measure cache latency with Intel MLC tool.

Measured values of listed parameters are especially important for repeatable zero packet loss throughput measurements across multiple system instances. Generally they come useful as a background data for comparing data plane performance results across disparate servers.

Following sections include measured calibration data for Intel Xeon Haswell and Intel Xeon Skylake testbeds.

### 3.7.4 Calibration Data - Haswell

Following sections include sample calibration data measured on t1-sut1 server running in one of the Intel Xeon Haswell testbeds as specified in [CSIT/Testbeds: Xeon Hsw, VIRL](#)<sup>152</sup>.

Calibration data obtained from all other servers in Haswell testbeds shows the same or similar values.

<sup>148</sup> [https://wiki.fd.io/view/CSIT/Testbeds:\\_Xeon\\_Hsw,\\_VIRL.#FD.io\\_CSIT\\_testbeds\\_-\\_Xeon\\_Haswell.2C\\_VIRL](https://wiki.fd.io/view/CSIT/Testbeds:_Xeon_Hsw,_VIRL.#FD.io_CSIT_testbeds_-_Xeon_Haswell.2C_VIRL)

<sup>149</sup> [https://wiki.fd.io/view/CSIT/Testbeds:\\_Xeon\\_Skx,\\_Arm,\\_Atom.#Server\\_Specification](https://wiki.fd.io/view/CSIT/Testbeds:_Xeon_Skx,_Arm,_Atom.#Server_Specification)

<sup>150</sup> [https://git.fd.io/pma\\_tools/tree/jitter](https://git.fd.io/pma_tools/tree/jitter)

<sup>151</sup> <https://software.intel.com/en-us/articles/intelr-memory-latency-checker>

<sup>152</sup> [https://wiki.fd.io/view/CSIT/Testbeds:\\_Xeon\\_Hsw,\\_VIRL.#FD.io\\_CSIT\\_testbeds\\_-\\_Xeon\\_Haswell.2C\\_VIRL](https://wiki.fd.io/view/CSIT/Testbeds:_Xeon_Hsw,_VIRL.#FD.io_CSIT_testbeds_-_Xeon_Haswell.2C_VIRL)

## Linux cmdline

```
$ cat /proc/cmdline
BOOT_IMAGE=/vmlinuz-4.15.0-36-generic root=UUID=5d2ecc97-245b-4e94-b0ae-c3548567de19 ro isolcpus=1-
↪17,19-35 nohz_full=1-17,19-35 rcu_nocbs=1-17,19-35 numa_balancing=disable intel_pstate=disable_
↪intel_iommu=on iommu=pt nmi_watchdog=0 audit=0 nosoftlockup processor.max_cstate=1 intel_idle.max_
↪cstate=1 hpet=disable tsc=reliable mce=off console=tty0 console=ttyS0,115200n8
```

## Linux uname

```
$ uname -a
Linux t1-tg1 4.15.0-36-generic #39-Ubuntu SMP Mon Sep 24 16:19:09 UTC 2018 x86_64 x86_64 x86_64 GNU/
↪Linux
```

## System-level Core Jitter

```
$ sudo taskset -c 3 /home/testuser/pma_tools/jitter/jitter -i 30
Linux Jitter testing program version 1.8
Iterations=30
The program will execute a dummy function 80000 times
Display is updated every 20000 displayUpdate intervals
Timings are in CPU Core cycles
Inst_Min:   Minimum Excution time during the display update interval(default is ~1 second)
Inst_Max:   Maximum Excution time during the display update interval(default is ~1 second)
Inst_jitter: Jitter in the Excution time during rhe display update interval. This is the value of _
↪interest
last_Exec:  The Excution time of last iteration just before the display update
Abs_Min:    Absolute Minimum Excution time since the program started or statistics were reset
Abs_Max:    Absolute Maximum Excution time since the program started or statistics were reset
tmp:        Cumulative value calcaulted by the dummy function
Interval:   Time interval between the display updates in Core Cycles
Sample No:  Sample number
```

Inst_Min	Inst_Max	Inst_jitter	last_Exec	Abs_min	Abs_max	tmp	Interval	
↪Sample No								
160024	172636	12612	160028	160024	172636	1573060608	3205463144	↪
↪1								
160024	188236	28212	160028	160024	188236	958595072	3205500844	↪
↪2								
160024	185676	25652	160028	160024	188236	344129536	3205485976	↪
↪3								
160024	172608	12584	160024	160024	188236	4024631296	3205472740	↪
↪4								
160024	179260	19236	160028	160024	188236	3410165760	3205502164	↪
↪5								
160024	172432	12408	160024	160024	188236	2795700224	3205452036	↪
↪6								
160024	178820	18796	160024	160024	188236	2181234688	3205455408	↪
↪7								
160024	172512	12488	160028	160024	188236	1566769152	3205461528	↪
↪8								
160024	172636	12612	160028	160024	188236	952303616	3205478820	↪
↪9								
160024	173676	13652	160028	160024	188236	337838080	3205470412	↪
↪10								
160024	178776	18752	160028	160024	188236	4018339840	3205481472	↪
↪11								
160024	172788	12764	160028	160024	188236	3403874304	3205492336	↪
↪12								

(continues on next page)

(continued from previous page)

	160024	174616	14592	160028	160024	188236	2789408768	3205474904	┆
↔13									
	160024	174440	14416	160028	160024	188236	2174943232	3205479448	┆
↔14									
	160024	178748	18724	160024	160024	188236	1560477696	3205482668	┆
↔15									
	160024	172588	12564	169404	160024	188236	946012160	3205510496	┆
↔16									
	160024	172636	12612	160024	160024	188236	331546624	3205472204	┆
↔17									
	160024	172480	12456	160024	160024	188236	4012048384	3205455864	┆
↔18									
	160024	172740	12716	160028	160024	188236	3397582848	3205464932	┆
↔19									
	160024	179200	19176	160028	160024	188236	2783117312	3205476012	┆
↔20									
	160024	172480	12456	160028	160024	188236	2168651776	3205465632	┆
↔21									
	160024	172728	12704	160024	160024	188236	1554186240	3205497204	┆
↔22									
	160024	172620	12596	160028	160024	188236	939720704	3205466972	┆
↔23									
	160024	172640	12616	160028	160024	188236	325255168	3205471216	┆
↔24									
	160024	172484	12460	160028	160024	188236	4005756928	3205467388	┆
↔25									
	160024	172636	12612	160028	160024	188236	3391291392	3205482748	┆
↔26									
	160024	179056	19032	160024	160024	188236	2776825856	3205467152	┆
↔27									
	160024	172672	12648	160024	160024	188236	2162360320	3205483268	┆
↔28									
	160024	176932	16908	160024	160024	188236	1547894784	3205488536	┆
↔29									
	160024	172452	12428	160028	160024	188236	933429248	3205440636	┆
↔30									

## Memory Bandwidth

```
$ sudo /home/testuser/mlc --bandwidth_matrix
Intel(R) Memory Latency Checker - v3.5
Command line parameters: --bandwidth_matrix

Using buffer size of 100.000MB/thread for reads and an additional 100.000MB/thread for writes
Measuring Memory Bandwidths between nodes within system
Bandwidths are in MB/sec (1 MB/sec = 1,000,000 Bytes/sec)
Using all the threads from each core if Hyper-threading is enabled
Using Read-only traffic type
      Numa node
Numa node    0      1
0             57935.5  30265.2
1             30284.6  58409.9
```

```
$ sudo /home/testuser/mlc --peak_injection_bandwidth
Intel(R) Memory Latency Checker - v3.5
Command line parameters: --peak_injection_bandwidth

Using buffer size of 100.000MB/thread for reads and an additional 100.000MB/thread for writes
```

(continues on next page)

(continued from previous page)

```

Measuring Peak Injection Memory Bandwidths for the system
Bandwidths are in MB/sec (1 MB/sec = 1,000,000 Bytes/sec)
Using all the threads from each core if Hyper-threading is enabled
Using traffic with the following read-write ratios
ALL Reads      : 115762.2
3:1 Reads-Writes : 106242.2
2:1 Reads-Writes : 103031.8
1:1 Reads-Writes : 87943.7
Stream-triad like: 100048.4

```

```

$ sudo /home/testuser/mlc --max_bandwidth
Intel(R) Memory Latency Checker - v3.5
Command line parameters: --max_bandwidth

Using buffer size of 100.000MB/thread for reads and an additional 100.000MB/thread for writes

Measuring Maximum Memory Bandwidths for the system
Will take several minutes to complete as multiple injection rates will be tried to get the best_
↔_bandwidth
Bandwidths are in MB/sec (1 MB/sec = 1,000,000 Bytes/sec)
Using all the threads from each core if Hyper-threading is enabled
Using traffic with the following read-write ratios
ALL Reads      : 115782.41
3:1 Reads-Writes : 105965.78
2:1 Reads-Writes : 103162.38
1:1 Reads-Writes : 88255.82
Stream-triad like: 105608.10

```

## Memory Latency

```

$ sudo /home/testuser/mlc --latency_matrix
Intel(R) Memory Latency Checker - v3.5
Command line parameters: --latency_matrix

Using buffer size of 200.000MB
Measuring idle latencies (in ns)...

```

	Numa node	
Numa node	0	1
0	101.0	132.0
1	141.2	98.8

```

$ sudo /home/testuser/mlc --idle_latency
Intel(R) Memory Latency Checker - v3.5
Command line parameters: --idle_latency

Using buffer size of 200.000MB
Each iteration took 227.2 core clocks ( 99.0 ns)

```

```

$ sudo /home/testuser/mlc --loaded_latency
Intel(R) Memory Latency Checker - v3.5
Command line parameters: --loaded_latency

Using buffer size of 100.000MB/thread for reads and an additional 100.000MB/thread for writes

Measuring Loaded Latencies for the system
Using all the threads from each core if Hyper-threading is enabled
Using Read-only traffic type
Inject Latency Bandwidth

```

(continues on next page)

(continued from previous page)

Delay	(ns)	MB/sec
00000	294.08	115841.6
00002	294.27	115851.5
00008	293.67	115821.8
00015	278.92	115587.5
00050	246.80	113991.2
00100	206.86	104508.1
00200	123.72	72873.6
00300	113.35	52641.1
00400	108.89	41078.9
00500	108.11	33699.1
00700	106.19	24878.0
01000	104.75	17948.1
01300	103.72	14089.0
01700	102.95	11013.6
02500	102.25	7756.3
03500	101.81	5749.3
05000	101.46	4230.4
09000	101.05	2641.4
20000	100.77	1542.5

### L1/L2/LLC Latency

```
$ sudo /home/testuser/mlc --c2c_latency
Intel(R) Memory Latency Checker - v3.5
Command line parameters: --c2c_latency

Measuring cache-to-cache transfer latency (in ns)...
Local Socket L2->L2 HIT latency      42.1
Local Socket L2->L2 HITM latency     47.0
Remote Socket L2->L2 HITM latency (data address homed in writer socket)
      Reader Numa Node
Writer Numa Node   0      1
                  0      - 108.0
                  1    106.9   -
Remote Socket L2->L2 HITM latency (data address homed in reader socket)
      Reader Numa Node
Writer Numa Node   0      1
                  0      - 107.7
                  1    106.6   -
```

### Spectre and Meltdown Checks

Following section displays the output of a running shell script to tell if system is vulnerable against the several “speculative execution” CVEs that were made public in 2018. Script is available on [Spectre & Meltdown Checker Github](#)<sup>153</sup>.

- CVE-2017-5753 [bounds check bypass] aka ‘Spectre Variant 1’
- CVE-2017-5715 [branch target injection] aka ‘Spectre Variant 2’
- CVE-2017-5754 [rogue data cache load] aka ‘Meltdown’ aka ‘Variant 3’
- CVE-2018-3640 [rogue system register read] aka ‘Variant 3a’
- CVE-2018-3639 [speculative store bypass] aka ‘Variant 4’
- CVE-2018-3615 [L1 terminal fault] aka ‘Foreshadow (SGX)’

<sup>153</sup> <https://github.com/speed47/spectre-meltdown-checker>



- CVE-2018-3620 [L1 terminal fault] aka 'Foreshadow-NG (OS)'
- CVE-2018-3646 [L1 terminal fault] aka 'Foreshadow-NG (VMM)'

```

$ sudo ./spectre-meltdown-checker.sh --no-color

Spectre and Meltdown mitigation detection tool v0.40

Checking for vulnerabilities on current system
Kernel is Linux 4.15.0-36-generic #39-Ubuntu SMP Mon Sep 24 16:19:09 UTC 2018 x86_64
CPU is Intel(R) Xeon(R) CPU E5-2699 v3 @ 2.30GHz

Hardware check
* Hardware support (CPU microcode) for mitigation techniques
  * Indirect Branch Restricted Speculation (IBRS)
    * SPEC_CTRL MSR is available: YES
    * CPU indicates IBRS capability: YES (SPEC_CTRL feature bit)
  * Indirect Branch Prediction Barrier (IBPB)
    * PRED_CMD MSR is available: YES
    * CPU indicates IBPB capability: YES (SPEC_CTRL feature bit)
  * Single Thread Indirect Branch Predictors (STIBP)
    * SPEC_CTRL MSR is available: YES
    * CPU indicates STIBP capability: YES (Intel STIBP feature bit)
  * Speculative Store Bypass Disable (SSBD)
    * CPU indicates SSBD capability: YES (Intel SSBD)
  * L1 data cache invalidation
    * FLUSH_CMD MSR is available: YES
    * CPU indicates L1D flush capability: YES (L1D flush feature bit)
  * Enhanced IBRS (IBRS_ALL)
    * CPU indicates ARCH_CAPABILITIES MSR availability: NO
    * ARCH_CAPABILITIES MSR advertises IBRS_ALL capability: NO
  * CPU explicitly indicates not being vulnerable to Meltdown (RDCL_NO): NO
  * CPU explicitly indicates not being vulnerable to Variant 4 (SSB_NO): NO
  * CPU/Hypervisor indicates L1D flushing is not necessary on this system: NO
  * Hypervisor indicates host CPU might be vulnerable to RSB underflow (RSBA): NO
  * CPU supports Software Guard Extensions (SGX): NO
  * CPU microcode is known to cause stability problems: NO (model 0x3f family 0x6 stepping 0x2_
↳ ucode 0x3d cpuid 0x306f2)
    * CPU microcode is the latest known available version: YES (latest version is 0x3d dated 2018/04/
↳ 20 according to builtin MCEExtractor DB v84 - 2018/09/27)
* CPU vulnerability to the speculative execution attack variants
  * Vulnerable to CVE-2017-5753 (Spectre Variant 1, bounds check bypass): YES
  * Vulnerable to CVE-2017-5715 (Spectre Variant 2, branch target injection): YES
  * Vulnerable to CVE-2017-5754 (Variant 3, Meltdown, rogue data cache load): YES
  * Vulnerable to CVE-2018-3640 (Variant 3a, rogue system register read): YES
  * Vulnerable to CVE-2018-3639 (Variant 4, speculative store bypass): YES
  * Vulnerable to CVE-2018-3615 (Foreshadow (SGX), L1 terminal fault): NO
  * Vulnerable to CVE-2018-3620 (Foreshadow-NG (OS), L1 terminal fault): YES
  * Vulnerable to CVE-2018-3646 (Foreshadow-NG (VMM), L1 terminal fault): YES

CVE-2017-5753 aka 'Spectre Variant 1, bounds check bypass'
* Mitigated according to the /sys interface: YES (Mitigation: __user pointer sanitization)
* Kernel has array_index_mask_nospec: YES (1 occurrence(s) found of x86 64 bits array_index_mask_
↳ nospec())
* Kernel has the Red Hat/Ubuntu patch: NO
* Kernel has mask_nospec64 (arm64): NO
> STATUS: NOT VULNERABLE (Mitigation: __user pointer sanitization)

CVE-2017-5715 aka 'Spectre Variant 2, branch target injection'
* Mitigated according to the /sys interface: YES (Mitigation: Full generic retpoline, IBPB, IBRS_FW)
* Mitigation 1
  * Kernel is compiled with IBRS support: YES
    * IBRS enabled and active: YES (for kernel and firmware code)

```

(continues on next page)

(continued from previous page)

```

* Kernel is compiled with IBPB support: YES
  * IBPB enabled and active: YES
* Mitigation 2
  * Kernel has branch predictor hardening (arm): NO
  * Kernel compiled with retpoline option: YES
    * Kernel compiled with a retpoline-aware compiler: YES (kernel reports full retpoline_
↳ compilation)
> STATUS: NOT VULNERABLE (Full retpoline + IBPB are mitigating the vulnerability)

CVE-2017-5754 aka 'Variant 3, Meltdown, rogue data cache load'
* Mitigated according to the /sys interface: YES (Mitigation: PTI)
* Kernel supports Page Table Isolation (PTI): YES
  * PTI enabled and active: YES
  * Reduced performance impact of PTI: YES (CPU supports INVPCID, performance impact of PTI will be_
↳ greatly reduced)
* Running as a Xen PV DomU: NO
> STATUS: NOT VULNERABLE (Mitigation: PTI)

CVE-2018-3640 aka 'Variant 3a, rogue system register read'
* CPU microcode mitigates the vulnerability: YES
> STATUS: NOT VULNERABLE (your CPU microcode mitigates the vulnerability)

CVE-2018-3639 aka 'Variant 4, speculative store bypass'
* Mitigated according to the /sys interface: YES (Mitigation: Speculative Store Bypass disabled via_
↳ prctl and seccomp)
* Kernel supports speculation store bypass: YES (found in /proc/self/status)
> STATUS: NOT VULNERABLE (Mitigation: Speculative Store Bypass disabled via prctl and seccomp)

CVE-2018-3615 aka 'Foreshadow (SGX), L1 terminal fault'
* CPU microcode mitigates the vulnerability: N/A
> STATUS: NOT VULNERABLE (your CPU vendor reported your CPU model as not vulnerable)

CVE-2018-3620 aka 'Foreshadow-NG (OS), L1 terminal fault'
* Mitigated according to the /sys interface: YES (Mitigation: PTE Inversion)
* Kernel supports PTE inversion: YES (found in kernel image)
* PTE inversion enabled and active: YES
> STATUS: NOT VULNERABLE (Mitigation: PTE Inversion)

CVE-2018-3646 aka 'Foreshadow-NG (VMM), L1 terminal fault'
* Information from the /sys interface: VMX: conditional cache flushes, SMT disabled
* This system is a host running an hypervisor: NO
* Mitigation 1 (KVM)
  * EPT is disabled: NO
* Mitigation 2
  * L1D flush is supported by kernel: YES (found flush_l1d in /proc/cpuinfo)
  * L1D flush enabled: YES (conditional flushes)
  * Hardware-backed L1D flush supported: YES (performance impact of the mitigation will be greatly_
↳ reduced)
  * Hyper-Threading (SMT) is enabled: NO
> STATUS: NOT VULNERABLE (this system is not running an hypervisor)

> SUMMARY: CVE-2017-5753:OK CVE-2017-5715:OK CVE-2017-5754:OK CVE-2018-3640:OK CVE-2018-3639:OK CVE-
↳ 2018-3615:OK CVE-2018-3620:OK CVE-2018-3646:OK

Need more detailed information about mitigation options? Use --explain
A false sense of security is worse than no security at all, see --disclaimer

```

### 3.7.5 Calibration Data - Skylake

Following sections include sample calibration data measured on s11-t31-sut1 server running in one of the Intel Xeon Skylake testbeds as specified in [CSIT Testbeds: Xeon Skx, Arm, Atom](#)<sup>154</sup>.

Calibration data obtained from all other servers in Skylake testbeds shows the same or similar values.

#### Linux cmdline

```
$ cat /proc/cmdline
BOOT_IMAGE=/vmlinuz-4.15.0-23-generic root=UUID=759ad671-ad46-441b-a75b-9f54e81837bb ro isolcpus=1-
↪27,29-55,57-83,85-111 nohz_full=1-27,29-55,57-83,85-111 rcu_nocbs=1-27,29-55,57-83,85-111 numa_
↪balancing=disable intel_pstate=disable intel_iommu=on iommu=pt nmi_watchdog=0 audit=0_
↪nosoftlockup processor.max_cstate=1 intel_idle.max_cstate=1 hpet=disable tsc=reliable mce=off_
↪console=tty0 console=ttyS0,115200n8
```

#### Linux uname

```
$ uname -a
Linux s5-t22-sut1 4.15.0-23-generic #25-Ubuntu SMP Wed May 23 18:02:16 UTC 2018 x86_64 x86_64 x86_
↪64 GNU/Linux
```

#### System-level Core Jitter

```
$ sudo taskset -c 3 /home/testuser/pma_tools/jitter/jitter -i 20
Linux Jitter testing program version 1.8
Iterations=20
The program will execute a dummy function 80000 times
Display is updated every 20000 displayUpdate intervals
Timings are in CPU Core cycles
Inst_Min:   Minimum Execution time during the display update interval(default is ~1 second)
Inst_Max:   Maximum Execution time during the display update interval(default is ~1 second)
Inst_jitter: Jitter in the Execution time during the display update interval. This is the value of_
↪interest
last_Exec:  The Execution time of last iteration just before the display update
Abs_Min:   Absolute Minimum Execution time since the program started or statistics were reset
Abs_Max:   Absolute Maximum Execution time since the program started or statistics were reset
tmp:       Cumulative value calculated by the dummy function
Interval:  Time interval between the display updates in Core Cycles
Sample No: Sample number
```

Inst_Min	Inst_Max	Inst_jitter	last_Exec	Abs_min	Abs_max	tmp	Interval
↪Sample No							
160022	171330	11308	160022	160022	171330	2538733568	3204142750
↪1							
160022	167294	7272	160026	160022	171330	328335360	3203873548
↪2							
160022	167560	7538	160026	160022	171330	2412904448	3203878736
↪3							
160022	169000	8978	160024	160022	171330	202506240	3203864588
↪4							
160022	166572	6550	160026	160022	171330	2287075328	3203866224
↪5							
160022	167460	7438	160026	160022	171330	76677120	3203854632
↪6							
160022	168134	8112	160024	160022	171330	2161246208	3203874674
↪7							

(continues on next page)

<sup>154</sup> [https://wiki.fd.io/view/CSIT/Testbeds:\\_Xeon\\_Skx,\\_Arm,\\_Atom.#Server\\_Specification](https://wiki.fd.io/view/CSIT/Testbeds:_Xeon_Skx,_Arm,_Atom.#Server_Specification)

(continued from previous page)

	160022	169094	9072	160022	160022	171330	4245815296	3203878798	↵
↵8	160022	172460	12438	160024	160022	172460	2035417088	3204112010	↵
↵9	160022	167862	7840	160030	160022	172460	4119986176	3203856800	↵
↵10	160022	168398	8376	160024	160022	172460	1909587968	3203854192	↵
↵11	160022	167548	7526	160024	160022	172460	3994157056	3203847442	↵
↵12	160022	167562	7540	160026	160022	172460	1783758848	3203862936	↵
↵13	160022	167604	7582	160024	160022	172460	3868327936	3203859346	↵
↵14	160022	168262	8240	160024	160022	172460	1657929728	3203851120	↵
↵15	160022	169700	9678	160024	160022	172460	3742498816	3203877690	↵
↵16	160022	170476	10454	160026	160022	172460	1532100608	3204088480	↵
↵17	160022	167798	7776	160024	160022	172460	3616669696	3203862072	↵
↵18	160022	166540	6518	160024	160022	172460	1406271488	3203836904	↵
↵19	160022	167516	7494	160024	160022	172460	3490840576	3203848120	↵
↵20									

### Memory Bandwidth

```
$ sudo /home/testuser/mlc --bandwidth_matrix
Intel(R) Memory Latency Checker - v3.5
Command line parameters: --bandwidth_matrix

Using buffer size of 100.000MB/thread for reads and an additional 100.000MB/thread for writes
Measuring Memory Bandwidths between nodes within system
Bandwidths are in MB/sec (1 MB/sec = 1,000,000 Bytes/sec)
Using all the threads from each core if Hyper-threading is enabled
Using Read-only traffic type
      Numa node
Numa node  0      1
0          107947.7  50951.5
1          50834.6  108183.4
```

```
$ sudo /home/testuser/mlc --peak_injection_bandwidth
Intel(R) Memory Latency Checker - v3.5
Command line parameters: --peak_injection_bandwidth

Using buffer size of 100.000MB/thread for reads and an additional 100.000MB/thread for writes

Measuring Peak Injection Memory Bandwidths for the system
Bandwidths are in MB/sec (1 MB/sec = 1,000,000 Bytes/sec)
Using all the threads from each core if Hyper-threading is enabled
Using traffic with the following read-write ratios
ALL Reads      : 215733.9
3:1 Reads-Writes : 182141.9
2:1 Reads-Writes : 178615.7
1:1 Reads-Writes : 149911.3
Stream-triad like: 159533.6
```

```

$ sudo /home/testuser/mlc --max_bandwidth
Intel(R) Memory Latency Checker - v3.5
Command line parameters: --max_bandwidth

Using buffer size of 100.000MB/thread for reads and an additional 100.000MB/thread for writes

Measuring Maximum Memory Bandwidths for the system
Will take several minutes to complete as multiple injection rates will be tried to get the best_
↪bandwidth
Bandwidths are in MB/sec (1 MB/sec = 1,000,000 Bytes/sec)
Using all the threads from each core if Hyper-threading is enabled
Using traffic with the following read-write ratios
ALL Reads      : 216875.73
3:1 Reads-Writes : 182615.14
2:1 Reads-Writes : 178745.67
1:1 Reads-Writes : 149485.27
Stream-triad like: 180057.87

```

## Memory Latency

```

$ sudo /home/testuser/mlc --latency_matrix
Intel(R) Memory Latency Checker - v3.5
Command line parameters: --latency_matrix

Using buffer size of 2000.000MB
Measuring idle latencies (in ns)...
      Numa node
Numa node  0      1
      0      81.4   131.1
      1     131.1   81.3

```

```

$ sudo /home/testuser/mlc --idle_latency
Intel(R) Memory Latency Checker - v3.5
Command line parameters: --idle_latency

Using buffer size of 2000.000MB
Each iteration took 202.0 core clocks ( 80.8 ns)

```

```

$ sudo /home/testuser/mlc --loaded_latency
Intel(R) Memory Latency Checker - v3.5
Command line parameters: --loaded_latency

Using buffer size of 100.000MB/thread for reads and an additional 100.000MB/thread for writes

Measuring Loaded Latencies for the system
Using all the threads from each core if Hyper-threading is enabled
Using Read-only traffic type
Inject Latency Bandwidth
Delay (ns) MB/sec
=====
00000 282.66 215712.8
00002 282.14 215757.4
00008 280.21 215868.1
00015 279.20 216313.2
00050 275.25 216643.0
00100 227.05 215075.0
00200 121.92 160242.9
00300 101.21 111587.4
00400 95.48 85019.7

```

(continues on next page)

(continued from previous page)

00500	94.46	68717.3
00700	92.27	49742.2
01000	91.03	35264.8
01300	90.11	27396.3
01700	89.34	21178.7
02500	90.15	14672.8
03500	89.00	10715.7
05000	82.00	7788.2
09000	81.46	4684.0
20000	81.40	2541.9

### L1/L2/LLC Latency

```
$ sudo /home/testuser/mlc --c2c_latency
Intel(R) Memory Latency Checker - v3.5
Command line parameters: --c2c_latency

Measuring cache-to-cache transfer latency (in ns)...
Local Socket L2->L2 HIT latency    53.7
Local Socket L2->L2 HITM latency   53.7
Remote Socket L2->L2 HITM latency (data address homed in writer socket)
      Reader Numa Node
Writer Numa Node    0      1
                   0      - 113.9
                   1     113.9  -
Remote Socket L2->L2 HITM latency (data address homed in reader socket)
      Reader Numa Node
Writer Numa Node    0      1
                   0      - 177.9
                   1     177.6  -
```

### Spectre and Meltdown Checks

Following section displays the output of a running shell script to tell if system is vulnerable against the several “speculative execution” CVEs that were made public in 2018. Script is available on [Spectre & Meltdown Checker Github](#)<sup>155</sup>.

- CVE-2017-5753 [bounds check bypass] aka ‘Spectre Variant 1’
- CVE-2017-5715 [branch target injection] aka ‘Spectre Variant 2’
- CVE-2017-5754 [rogue data cache load] aka ‘Meltdown’ aka ‘Variant 3’
- CVE-2018-3640 [rogue system register read] aka ‘Variant 3a’
- CVE-2018-3639 [speculative store bypass] aka ‘Variant 4’
- CVE-2018-3615 [L1 terminal fault] aka ‘Foreshadow (SGX)’
- CVE-2018-3620 [L1 terminal fault] aka ‘Foreshadow-NG (OS)’
- CVE-2018-3646 [L1 terminal fault] aka ‘Foreshadow-NG (VMM)’

```
$ sudo ./spectre-meltdown-checker.sh --no-color

Spectre and Meltdown mitigation detection tool v0.40

Checking for vulnerabilities on current system
Kernel is Linux 4.15.0-23-generic #25-Ubuntu SMP Wed May 23 18:02:16 UTC 2018 x86_64
```

(continues on next page)

<sup>155</sup> <https://github.com/speed47/spectre-meltdown-checker>

(continued from previous page)

```

CPU is Intel(R) Xeon(R) Platinum 8180 CPU @ 2.50GHz

Hardware check
* Hardware support (CPU microcode) for mitigation techniques
  * Indirect Branch Restricted Speculation (IBRS)
    * SPEC_CTRL MSR is available: YES
    * CPU indicates IBRS capability: YES (SPEC_CTRL feature bit)
  * Indirect Branch Prediction Barrier (IBPB)
    * PRED_CMD MSR is available: YES
    * CPU indicates IBPB capability: YES (SPEC_CTRL feature bit)
  * Single Thread Indirect Branch Predictors (STIBP)
    * SPEC_CTRL MSR is available: YES
    * CPU indicates STIBP capability: YES (Intel STIBP feature bit)
  * Speculative Store Bypass Disable (SSBD)
    * CPU indicates SSBD capability: NO
  * L1 data cache invalidation
    * FLUSH_CMD MSR is available: NO
    * CPU indicates L1D flush capability: NO
  * Enhanced IBRS (IBRS_ALL)
    * CPU indicates ARCH_CAPABILITIES MSR availability: NO
    * ARCH_CAPABILITIES MSR advertises IBRS_ALL capability: NO
  * CPU explicitly indicates not being vulnerable to Meltdown (RDCL_NO): NO
  * CPU explicitly indicates not being vulnerable to Variant 4 (SSB_NO): NO
  * CPU/Hypervisor indicates L1D flushing is not necessary on this system: NO
  * Hypervisor indicates host CPU might be vulnerable to RSB underflow (RSBA): NO
  * CPU supports Software Guard Extensions (SGX): NO
  * CPU microcode is known to cause stability problems: NO (model 0x55 family 0x6 stepping 0x4_
↳ ucode 0x2000043 cpuid 0x50654)
    * CPU microcode is the latest known available version: NO (latest version is 0x200004d dated 2018/
↳ 05/15 according to builtin MCEExtractor DB v84 - 2018/09/27)
* CPU vulnerability to the speculative execution attack variants
  * Vulnerable to CVE-2017-5753 (Spectre Variant 1, bounds check bypass): YES
  * Vulnerable to CVE-2017-5715 (Spectre Variant 2, branch target injection): YES
  * Vulnerable to CVE-2017-5754 (Variant 3, Meltdown, rogue data cache load): YES
  * Vulnerable to CVE-2018-3640 (Variant 3a, rogue system register read): YES
  * Vulnerable to CVE-2018-3639 (Variant 4, speculative store bypass): YES
  * Vulnerable to CVE-2018-3615 (Foreshadow (SGX), L1 terminal fault): NO
  * Vulnerable to CVE-2018-3620 (Foreshadow-NG (OS), L1 terminal fault): YES
  * Vulnerable to CVE-2018-3646 (Foreshadow-NG (VMM), L1 terminal fault): YES

CVE-2017-5753 aka 'Spectre Variant 1, bounds check bypass'
* Mitigated according to the /sys interface: YES (Mitigation: __user pointer sanitization)
* Kernel has array_index_mask_nospec: YES (1 occurrence(s) found of x86 64 bits array_index_mask_
↳ nospec())
* Kernel has the Red Hat/Ubuntu patch: NO
* Kernel has mask_nospec64 (arm64): NO
> STATUS: NOT VULNERABLE (Mitigation: __user pointer sanitization)

CVE-2017-5715 aka 'Spectre Variant 2, branch target injection'
* Mitigated according to the /sys interface: YES (Mitigation: Full generic retpoline, IBPB, IBRS_FW)
* Mitigation 1
  * Kernel is compiled with IBRS support: YES
    * IBRS enabled and active: YES (for kernel and firmware code)
  * Kernel is compiled with IBPB support: YES
    * IBPB enabled and active: YES
* Mitigation 2
  * Kernel has branch predictor hardening (arm): NO
  * Kernel compiled with retpoline option: YES
    * Kernel compiled with a retpoline-aware compiler: YES (kernel reports full retpoline_
↳ compilation)
  * Kernel supports RSB filling: YES

```

(continues on next page)

(continued from previous page)

```

> STATUS: NOT VULNERABLE (Full retpoline + IBPB are mitigating the vulnerability)

CVE-2017-5754 aka 'Variant 3, Meltdown, rogue data cache load'
* Mitigated according to the /sys interface: YES (Mitigation: PTI)
* Kernel supports Page Table Isolation (PTI): YES
  * PTI enabled and active: YES
  * Reduced performance impact of PTI: YES (CPU supports INVPCID, performance impact of PTI will be_
↳ greatly reduced)
* Running as a Xen PV DomU: NO
> STATUS: NOT VULNERABLE (Mitigation: PTI)

CVE-2018-3640 aka 'Variant 3a, rogue system register read'
* CPU microcode mitigates the vulnerability: NO
> STATUS: VULNERABLE (an up-to-date CPU microcode is needed to mitigate this vulnerability)

CVE-2018-3639 aka 'Variant 4, speculative store bypass'
* Mitigated according to the /sys interface: NO (Vulnerable)
* Kernel supports speculation store bypass: YES (found in /proc/self/status)
> STATUS: VULNERABLE (Your CPU doesn't support SSBD)

CVE-2018-3615 aka 'Foreshadow (SGX), L1 terminal fault'
* CPU microcode mitigates the vulnerability: N/A
> STATUS: NOT VULNERABLE (your CPU vendor reported your CPU model as not vulnerable)

CVE-2018-3620 aka 'Foreshadow-NG (OS), L1 terminal fault'
* Kernel supports PTE inversion: NO
* PTE inversion enabled and active: UNKNOWN (sysfs interface not available)
> STATUS: VULNERABLE (Your kernel doesn't support PTE inversion, update it)

CVE-2018-3646 aka 'Foreshadow-NG (VMM), L1 terminal fault'
* This system is a host running an hypervisor: NO
* Mitigation 1 (KVM)
  * EPT is disabled: NO
* Mitigation 2
  * L1D flush is supported by kernel: NO
  * L1D flush enabled: UNKNOWN (can't find or read /sys/devices/system/cpu/vulnerabilities/l1tf)
  * Hardware-backed L1D flush supported: NO (flush will be done in software, this is slower)
  * Hyper-Threading (SMT) is enabled: YES
> STATUS: NOT VULNERABLE (this system is not running an hypervisor)

> SUMMARY: CVE-2017-5753:OK CVE-2017-5715:OK CVE-2017-5754:OK CVE-2018-3640:KO CVE-2018-3639:KO CVE-
↳ 2018-3615:OK CVE-2018-3620:KO CVE-2018-3646:OK

Need more detailed information about mitigation options? Use --explain
A false sense of security is worse than no security at all, see --disclaimer

```

### 3.7.6 SUT Settings - Linux

System provisioning is done by combination of PXE boot unattended install and [Ansible](#)<sup>156</sup> described in [CSIT Testbed Setup](#)<sup>157</sup>.

Below a subset of the running configuration:

#### 1. Xeon Haswell - Ubuntu 18.04.1 LTS

```

$ lsb_release -a
No LSB modules are available.

```

(continues on next page)

<sup>156</sup> <https://www.ansible.com>

<sup>157</sup> <https://git.fd.io/csit/tree/resources/tools/testbed-setup/README.md?h=rls1901>



(continued from previous page)

```
Distributor ID: Ubuntu
Description:   Ubuntu 18.04.1 LTS
Release:      18.04
Codename:     bionic
```

## 2. Xeon Skylake - Ubuntu 18.04 LTS

```
$ lsb_release -a
No LSB modules are available.
Distributor ID: Ubuntu
Description:   Ubuntu 18.04 LTS
Release:      18.04
Codename:     bionic
```

## Linux Boot Parameters

- **isolcpus=<cpu number>-<cpu number>** used for all cpu cores apart from first core of each socket used for running VPP worker threads and Qemu/LXC processes <https://www.kernel.org/doc/Documentation/admin-guide/kernel-parameters.txt>
- **intel\_pstate=disable** - [X86] Do not enable intel\_pstate as the default scaling driver for the supported processors. Intel P-State driver decide what P-state (CPU core power state) to use based on requesting policy from the cpufreq core. [X86 - Either 32-bit or 64-bit x86] <https://www.kernel.org/doc/Documentation/cpu-freq/intel-pstate.txt>
- **nohz\_full=<cpu number>-<cpu number>** - [KNL,BOOT] In kernels built with CONFIG\_NO\_HZ\_FULL=y, set the specified list of CPUs whose tick will be stopped whenever possible. The boot CPU will be forced outside the range to maintain the timekeeping. The CPUs in this range must also be included in the rcu\_nocbs= set. Specifies the adaptive-ticks CPU cores, causing kernel to avoid sending scheduling-clock interrupts to listed cores as long as they have a single runnable task. [KNL - Is a kernel start-up parameter, SMP - The kernel is an SMP kernel]. [https://www.kernel.org/doc/Documentation/timers/NO\\_HZ.txt](https://www.kernel.org/doc/Documentation/timers/NO_HZ.txt)
- **rcu\_nocbs** - [KNL] In kernels built with CONFIG\_RCU\_NOCB\_CPU=y, set the specified list of CPUs to be no-callback CPUs, that never queue RCU callbacks (read-copy update). <https://www.kernel.org/doc/Documentation/admin-guide/kernel-parameters.txt>
- **numa\_balancing=disable** - [KNL,X86] Disable automatic NUMA balancing.
- **intel\_iommu=enable** - [DMAR] Enable Intel IOMMU driver (DMAR) option.
- **iommu=on, iommu=pt** - [x86, IA-64] Disable IOMMU bypass, using IOMMU for PCI devices.
- **nmi\_watchdog=0** - [KNL,BUGS=X86] Debugging features for SMP kernels. Turn hardlockup detector in nmi\_watchdog off.
- **nosoftlockup** - [KNL] Disable the soft-lockup detector.
- **tsc=reliable** - Disable clocksource stability checks for TSC. [x86] reliable: mark tsc clocksource as reliable, this disables clocksource verification at runtime, as well as the stability checks done at bootup. Used to enable high-resolution timer mode on older hardware, and in virtualized environment.
- **hpet=disable** - [X86-32,HPET] Disable HPET and use PIT instead.

## Applied Boot Cmdline

### 1. Xeon Haswell - Ubuntu 18.04.1 LTS

```
$ cat /proc/cmdline
BOOT_IMAGE=/vmlinuz-4.15.0-36-generic root=UUID=5d2ecc97-245b-4e94-b0ae-c3548567de19 ro isolcpus=1-
↵17,19-35 nohz_full=1-17,19-35 rcu_nocbs=1-17,19-35 numa_balancing=disable intel_iommu=enable
↵intel_iommu=on iommu=pt nmi_watchdog=0 audit=0 nosoftlockup processor.max_cstate=1 intel_idle.max_
↵cstate=1 hpet=disable tsc=reliable mce=off console=tty0 console=ttyS0,115200n8
```

(continued from previous page)

## 2. Xeon Skylake - Ubuntu 18.04 LTS

```
$ cat /proc/cmdline
BOOT_IMAGE=/vmlinuz-4.15.0-23-generic root=UUID=3fa246fd-1b80-4361-bb90-f339a6bbed51 ro isolcpus=1-
↳ 27,29-55,57-83,85-111 nohz_full=1-27,29-55,57-83,85-111 rcu_nocbs=1-27,29-55,57-83,85-111 numa_
↳ balancing=disable intel_pstate=disable intel_iommu=on iommu=pt nmi_watchdog=0 audit=0_
↳ nosoftlockup processor.max_cstate=1 intel_idle.max_cstate=1 hpet=disable tsc=reliable mce=off_
↳ console=tty0 console=ttyS0,115200n8
```

### Host Writeback Affinity

Writebacks are pinned to core 0. The same configuration is applied in host Linux and guest VM.

```
$ echo 1 | sudo tee /sys/bus/workqueue/devices/writeback/cpumask
```

## 3.7.7 DUT Settings - DPDK

### DPDK Version

DPDK 18.11

### DPDK Compile Parameters

```
make install T=x86_64-native-linuxapp-gcc -j
```

### Testpmd Startup Configuration

Testpmd startup configuration changes per test case with different settings for `$$CORES`, `$$RXQ` and `max-pkt-len` parameter if test is sending jumbo frames. Startup command template:

```
testpmd -c $$CORE_MASK -n 4 -- --numa --nb-ports=2 --portmask=0x3 --nb-cores=$$CORES --max-pkt-
↳ len=9000 --txqflags=0 --forward-mode=io --rxq=$$RXQ --txq=$$TXQ --burst=64 --rxd=1024 --txd=1024 -
↳ -disable-link-check --auto-start
```

### L3FWD Startup Configuration

L3FWD startup configuration changes per test case with different settings for `$$CORES` and `enable-jumbo` parameter if test is sending jumbo frames. Startup command template:

```
l3fwd -l $$CORE_LIST -n 4 -- -P -L -p 0x3 --config='${port_config}' --enable-jumbo --max-pkt-
↳ len=9000 --eth-dest=0,${adj_mac0} --eth-dest=1,${adj_mac1} --parse-ptype
```

## 3.7.8 TG Settings - TRex

### TG Version

TRex v2.35

### DPDK Version

DPDK v17.11

### TG Build Script Used

Trex intallation<sup>158</sup>

### TG Startup Configuration

```
$ cat /etc/trex_cfg.yaml
- port_limit      : 2
  version        : 2
  interfaces     : ["0000:0d:00.0", "0000:0d:00.1"]
  port_info      :
    - dest_mac   : [0x3c, 0xfd, 0xfe, 0x9c, 0xee, 0xf5]
      src_mac    : [0x3c, 0xfd, 0xfe, 0x9c, 0xee, 0xf4]
    - dest_mac   : [0x3c, 0xfd, 0xfe, 0x9c, 0xee, 0xf4]
      src_mac    : [0x3c, 0xfd, 0xfe, 0x9c, 0xee, 0xf5]
```

### TG Startup Command

```
$ sh -c 'cd <t-rex-install-dir>/scripts/ && sudo nohup ./t-rex-64 -i -c 7 --iom 0 > /tmp/trex.log 2>
->&1 &' > /dev/null
```

### TG API Driver

Trex driver<sup>159</sup>

## 3.8 Documentation

CSIT DPDK Performance Tests Documentation<sup>160</sup> contains detailed functional description and input parameters for each test case.

---

<sup>158</sup> [https://git.fd.io/csit/tree/resources/tools/trex/trex\\_installer.sh?h=rls1901](https://git.fd.io/csit/tree/resources/tools/trex/trex_installer.sh?h=rls1901)

<sup>159</sup> [https://git.fd.io/csit/tree/resources/tools/trex/trex\\_stateless\\_profile.py?h=rls1901](https://git.fd.io/csit/tree/resources/tools/trex/trex_stateless_profile.py?h=rls1901)

<sup>160</sup> <https://docs.fd.io/csit/rls1901/doc/tests.dpdk.perf.html>

### 4.1 Overview

#### 4.1.1 Virtual Topologies

CSIT VPP Device tests are executed in Physical containerized topologies created on demand using set of scripts hosted and developed under CSIT repository. It runs on physical baremetal servers hosted by LF FD.io project. Based on the packet path thru SUT Containers, three distinct logical topology types are used for VPP DUT data plane testing:

1. vNIC-to-vNIC switching topologies.
2. vNIC-to-vhost-user switching topologies.
3. vNIC-to-memif switching topologies.

#### **vNIC-to-vNIC Switching**

The simplest physical topology for software data plane application like VPP is vNIC-to-vNIC switching. Tested virtual topologies for 2-Node testbeds are shown in figures below.

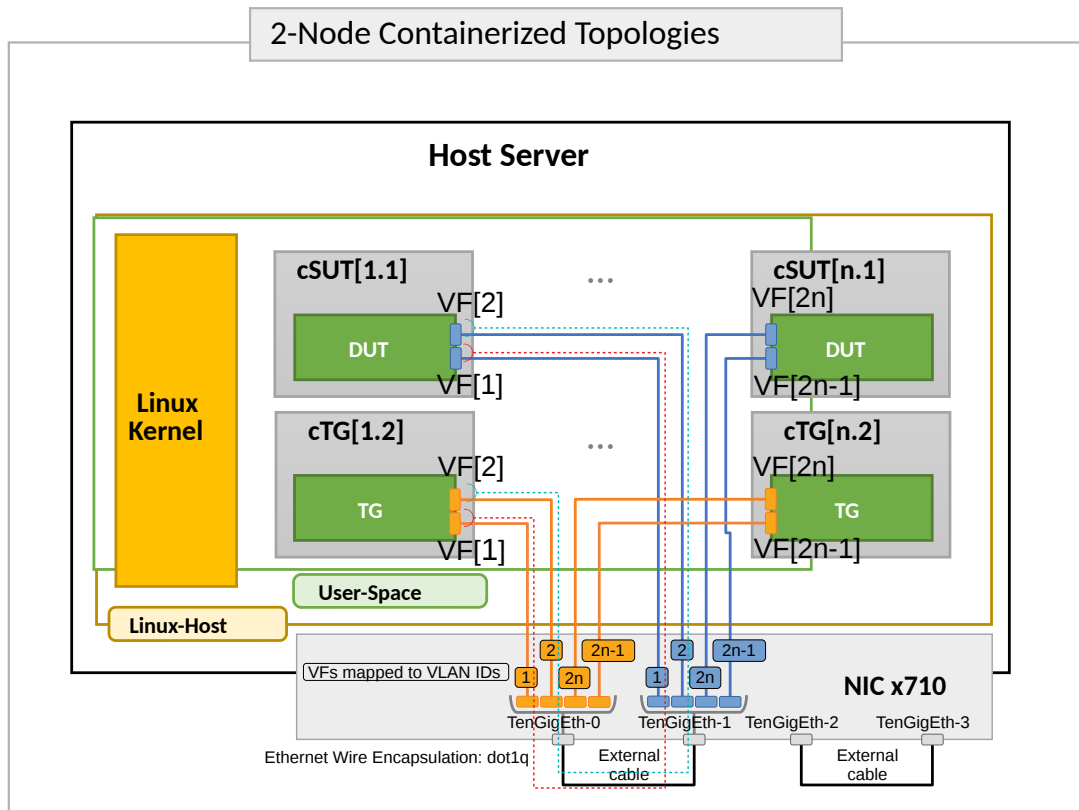

SUT1 is Docker Container (running Ubuntu, depending on the test suite), TG is a Traffic Generator (running Ubuntu Container). SUTs run VPP SW application in Linux user-mode as a Device Under Test (DUT) within the container. TG runs Scapy SW application as a packet Traffic Generator. Network connectivity between SUTs and to TG is provided using virtual function of physical NICs.

Virtual topologies are created on-demand whenever a verification job is started (e.g. triggered by the gerrit patch submission) and destroyed upon completion of all functional tests. Each node is a container running on physical server. During the test execution, all nodes are reachable thru the Management (not shown above for clarity).

### vfNIC-to-vhost-user Switching

vfNIC-to-vhost-user switching topology test cases require VPP DUT to communicate with Virtual Machine (VM) over Vhost-user virtual interfaces. VM is created on SUT1 for the duration of these particular test cases only. Virtual test topology with VM is shown in the figure below.

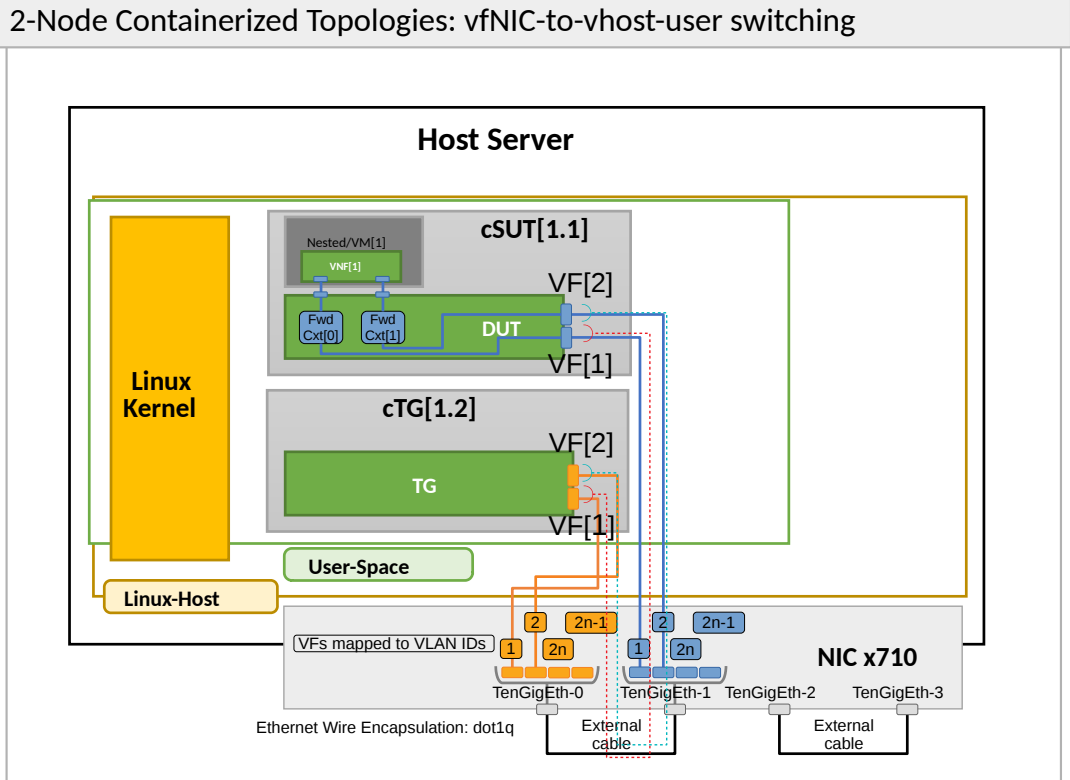

### vfNIC-to-memif Switching

vfNIC-to-memif switching topology test cases require VPP DUT to communicate with another Docker Container over memif interfaces. Container is created for the duration of these particular test cases only and it is running the same VPP version as running on DUT. Virtual test topology with Memif is shown in the figure below.

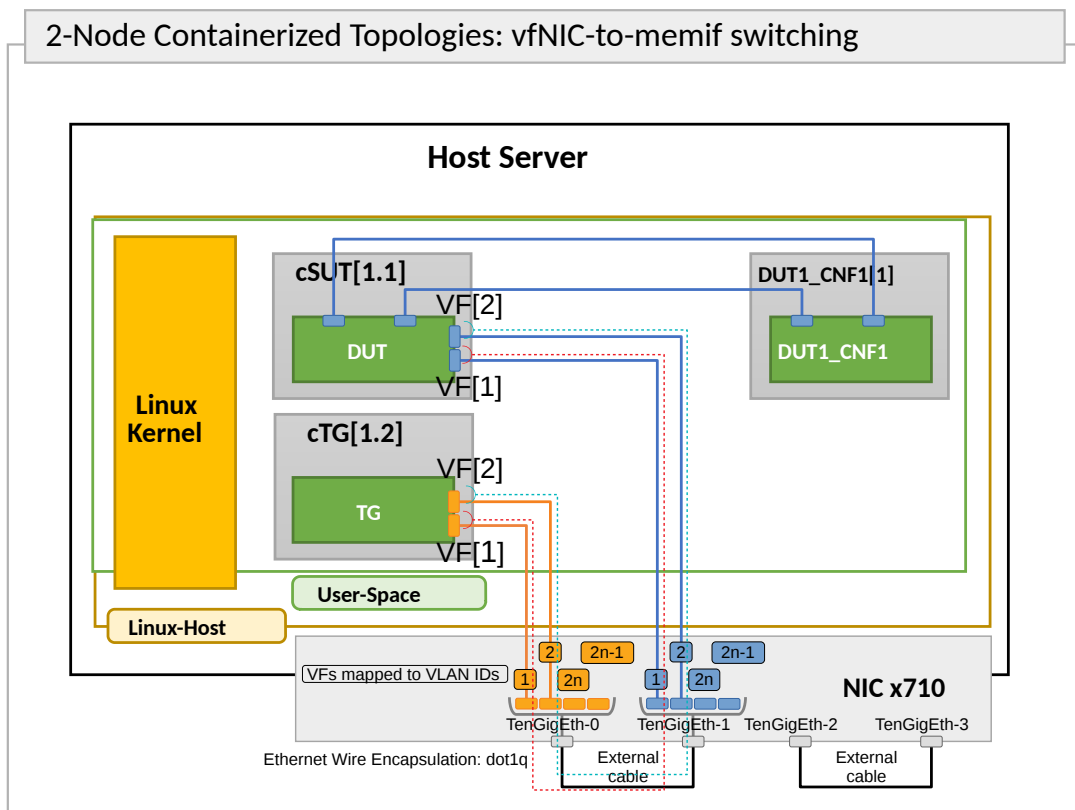

### 4.1.2 Functional Tests Coverage

CSIT-1901 includes following VPP functionality tested in VPP Device environment:

Functionality	Description
IPv4	IPv4 routing, ICMPv4.
IPv6	IPv4 routing, ICMPv6.
L2BD	L2 Bridge-Domain switching for untagged Ethernet.
L2XC	L2 Cross-Connect switching for untagged Ethernet.
Vhost-user Interface	Baseline VPP vhost-user interface tests.
Memif Interface	Baseline VPP memif interface tests.

### 4.1.3 Tests Naming

CSIT-1901 follows a common structured naming convention for all performance and system functional tests, introduced in CSIT-17.01.

The naming should be intuitive for majority of the tests. Complete description of CSIT test naming convention is provided on *Test Naming* (page 864).

## 4.2 Release Notes

### 4.2.1 Changes in CSIT-1901

1. TEST FRAMEWORK

- **VM and “nested” container support:** Framework has been extended to allow to run Virtual Machine (VM) on SUT1 and to start another Docker Container from SUT1.

## 2. NEW TESTS

- **L2BD and L2XC:** L2 Cross-Connect switching and L2 Bridge-Domain switching between vNICs for untagged ethernet.
- **VM\_Vhost:** VPP DUT is configured with IPv4/IPv6 routing or L2 cross-connect/bridge-domain switching between vNICs and Vhost-user interfaces. VM - Qemu Guest is connected to VPP via Vhost-user interfaces. Guest is configured with linux bridge interconnecting vhost-user interfaces.
- **Container\_Memif:** VPP DUT is configured with IPv4/IPv6 routing or L2 cross-connect/bridge-domain switching between vNICs and Memif interfaces. Container is connected to VPP via Memif interface. Container is running the same VPP version as running on DUT.

### 4.2.2 Known Issues

List of known issues in CSIT-1901 for VPP functional tests in VPP Device:

#	JiraID	Issue Description
1		

## 4.3 Integration Tests

### 4.3.1 Abstract

FD.io VPP software data plane technology has become very popular across a wide range of VPP ecosystem use cases, putting higher pressure on continuous verification of VPP software quality.

This document describes a proposal for design and implementation of extended continuous VPP testing by extending existing test environments. Furthermore it describes and summarizes implementation details of Integration and System tests platform *1-Node VPP\_Device*. It aims to provide a complete end-to-end view of *1-Node VPP\_Device* environment in order to improve extendability and maintenance, under the guideline of VPP core team.

The key words “MUST”, “MUST NOT”, “REQUIRED”, “SHALL”, “SHALL NOT”, “SHOULD”, “SHOULD NOT”, “RECOMMENDED”, “MAY”, and “OPTIONAL” in this document are to be interpreted as described in **RFC 8174**<sup>161</sup>.

<sup>161</sup> <https://tools.ietf.org/html/rfc8174.html>



### 4.3.2 Overview

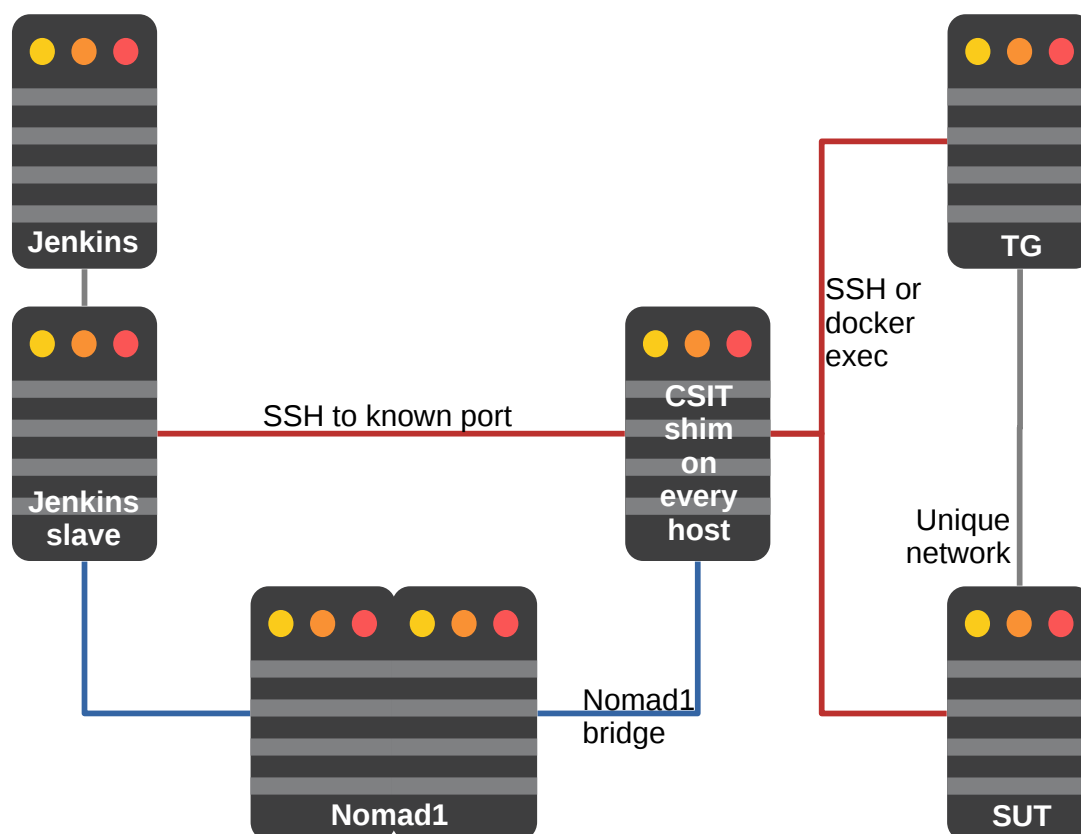

### 4.3.3 Physical Testbeds

All FD.io CSIT vpp-device tests are executed on physical testbeds built with bare-metal servers hosted by LF FD.io project. Two 1-node testbed topologies are used:

- **2-Container Topology:** Consisting of one Docker container acting as SUT (System Under Test) and one Docker container as TG (Traffic Generator), both connected in ring topology via physical NIC cross-connecting.

Current FD.io production testbeds are built with servers based on one processor generation of Intel Xeons: Skylake (Platinum 8180). Testbeds built with servers based on Arm processors are in the process of being added to FD.io production.

Following section describe existing production 1n-skx testbed.

#### 1-Node Xeon Skylake (1n-skx)

1n-skx testbed is based on single SuperMicro SYS-7049GP-TRT server equipped with two Intel Xeon Skylake Platinum 8180 2.5 GHz 28 core processors. Physical testbed topology is depicted in a figure below.

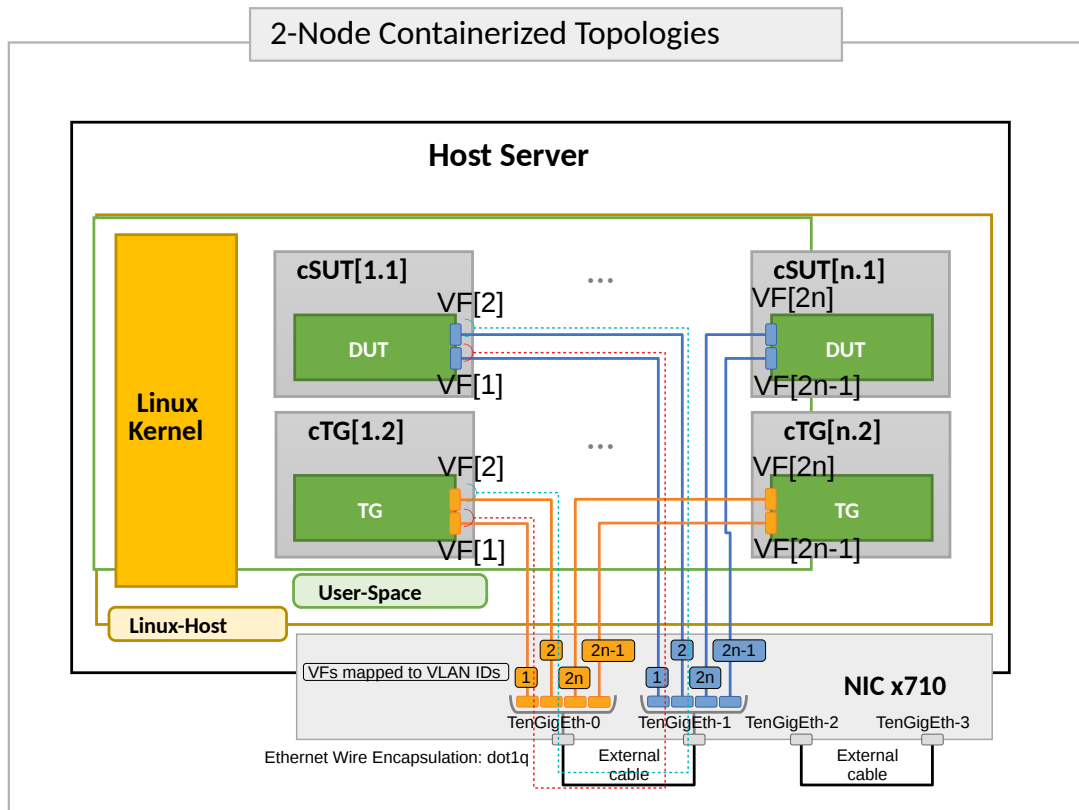

Server is populated with the following NIC models:

1. NIC-1: x710-da4 4p10GE Intel.
2. NIC-2: x710-da4 4p10GE Intel.

All Intel Xeon Skylake servers run with Intel Hyper-Threading enabled, doubling the number of logical cores exposed to Linux, with 56 logical cores and 28 physical cores per processor socket.

NIC interfaces are shared using Linux vfiopci and VPP VF drivers:

- DPDK VF driver,
- Fortville AVF driver.

Provided Intel x710-da4 4p10GE NICs support 32 VFs per interface, 128 per NIC.

Complete 1n-skx testbeds specification is available on [CSIT LF Testbeds<sup>162</sup>](#) wiki page.

Total of two 1n-skx testbeds are in operation in FD.io labs.

### 1-Node Virtualbox (1n-vbox)

1n-skx testbed can run in single VirtualBox VM machine. This solution replaces the previously used Vagrant environment based on 3 VMs.

VirtualBox VM MAY be created by Vagrant and MUST have additional 4 virtio NICs each pair attached to separate private networks to simulate back-to-back connections. It SHOULD be 82545EM device model (otherwise can be changed in bootstrap scripts). Example of Vagrant configuration:

```
Vagrant.configure(2) do |c|
  c.vm.network "private_network", type: "dhcp", auto_config: false,
```

(continues on next page)

<sup>162</sup> [https://wiki.fd.io/view/CSIT/Testbeds:\\_Xeon\\_Skx,\\_Arm,\\_Atom](https://wiki.fd.io/view/CSIT/Testbeds:_Xeon_Skx,_Arm,_Atom).

(continued from previous page)

```

    virtualbox__intnet: "port1", nic_type: "82545EM"
c.vm.network "private_network", type: "dhcp", auto_config: false,
    virtualbox__intnet: "port2", nic_type: "82545EM"

c.vm.provider :virtualbox do |v|
  v.customize ["modifyvm", :id, "--nicpromisc2", "allow-all"]
  v.customize ["modifyvm", :id, "--nicpromisc3", "allow-all"]
  v.customize ["modifyvm", :id, "--nicpromisc4", "allow-all"]
  v.customize ["modifyvm", :id, "--nicpromisc5", "allow-all"]

```

Vagrant VM is populated with the following NIC models:

1. NIC-1: 82545EM Intel.
2. NIC-2: 82545EM Intel.
3. NIC-3: 82545EM Intel.
4. NIC-4: 82545EM Intel.

### 4.3.4 Containers

It was agreed on TWS (Technical Work Stream) call to continue with Ubuntu 18.04 LTS as a baseline system with OPTIONAL extend to Centos 7 and SuSE per demand [TWSLink] (page 908).

All DCR (Docker container) images are REQUIRED to be hosted on Docker registry available from LF network, publicly available and trackable. For backup, tracking and contributing purposes all Dockerfiles (including files needed for building container) MUST be available and stored in [fdiocsitgerrit] (page 908) repository under appropriate folders. This allows the peer review process to be done for every change of infrastructure related to scope of this document. Currently only **csit-shim-dcr** and **csit-sut-dcr** containers will be stored and maintained under CSIT repository by CSIT contributors.

At the time of designing solution described in this document the interconnection between [dockerhub] (page 908) and [fdiocsitgerrit] (page 908) for automated build purposes and image hosting cannot be established with the trust and respectful to security of FD.io project. Unless addressed, DCR images will be placed in custom registry service [fdioregistry] (page 908). Automated Jenkins jobs will be created in align of long term solution for container lifecycle and ability to build new version of docker images.

In parallel, the effort is started to find the outsourced Docker registry service.

### Versioning

As of initial version of vpp-device, we do have only single latest version of Docker image hosted on [dockerhub] (page 908). This will be addressed as further improvement with proper semantic versioning.

### jenkins-slave-dcr

This DCR acts as the Jenkins slave (known also as jenkins minion). It can connect over SSH protocol to TCP port 6022 of **csit-shim-dcr** and executes non-interactive reservation script. Nomad is responsible for scheduling this container execution onto specific **1-Node VPP\_Device** testbed. It executes CSIT environment including CSIT framework.

All software dependencies including VPP/DPDK that are not present in **csit-sut-dcr** container image and/or needs to be compiled prior running on **csit-sut-dcr** SHOULD be compiled in this container.

- *Container Image Location*: Docker image at snergster/vpp-ubuntu18.
- *Container Definition*: Docker file specified at [JenkinsSlaveDcrFile] (page 908).
- *Initializing*: Container is initialized from within Consul by HashiCorp and Nomad by HashiCorp.

### csit-shim-dcr

This DCR acts as an intermediate layer running script responsible for orchestrating topologies under test and reservation. Responsible for managing VF resources and allocation to DUT (Device Under Test), TG (Traffic Generator) containers. This MUST to be done on **csit-shim-dcr**. This image also acts as the generic reservation mechanics arbiter to make sure that only Y number of simulations are spawned on any given HW node.

- *Container Image Location*: Docker image at snergster/csit-shim.
- *Container Definition*: Docker file specified at [CsitShimDcrFile] (page 908).
- *Initializing*: Container is initialized from within *Consul by HashiCorp* and *Nomad by HashiCorp*. Required docker parameters, to be able to run nested containers with VF reservation system are: privileged, net=host, pid=host.
- *Connectivity*: Over SSH only, using <host>:6022 format. Currently using root user account as primary. From the jenkins slave it will be able to connect via env variable, since the jenkins slave doesn't actually know what host its running on.

```
ssh -p 6022 root@10.30.51.node
```

### csit-sut-dcr

This DCR acts as an SUT (System Under Test). Any DUT or TG application is installed there. It is RECOMMENDED to install DUT and all DUT dependencies via commands `rpm -ihv` on RedHat based OS or `dpkg -i` on Debian based OS.

Container is designed to be a very lightweight Docker image that only installs packages and execute binaries (previously built or downloaded on **jenkins-slave-dcr**) and contains libraries necessary to run CSIT framework including those required by DUT/TG.

- *Container Image Location*: Docker image at snergster/csit-sut.
- *Container Definition*: Docker file specified at [CsitSutDcrFile] (page 908).
- *Initializing*:

```
docker run
# Run the container in the background and print the new container ID.
--detach=true
# Give extended privileges to this container. A "privileged" container is
# given access to all devices and able to run nested containers.
--privileged
# Publish all exposed ports to random ports on the host interfaces.
--publish-all
# Automatically remove the container when it exits.
--rm
# Size of /dev/shm.
--shm-size 512M
# Override access to PCI bus by attaching a filesystem mount to the
# container.
--mount type=tmpfs,destination=/sys/bus/pci/devices
# Mount vfio to be able to bind to see binded interfaces. We cannot use
# --device=/dev/vfio as this does not see newly binded interfaces.
--volume /dev/vfio:/dev/vfio
# Mount nested_vm image to be able to run VM tests.
--volume /var/lib/vm/vhost-nested.img:/var/lib/vm/vhost-nested.img
# Mount docker.sock to be able to use docker daemon of the host.
--volume /var/run/docker.sock:/var/run/docker.sock
# Image of csit-sut-dcr
snergster/csit-vpp-device-test:latest
```

Container name is catenated from **csit-** prefix and uuid generated uniquely for each container instance.

- **Connectivity:** Over SSH only, using `<host>[:<port>]` format. Currently using `root` user account as primary.

```
ssh -p <port> root@10.30.51.<node>
```

Container required to run as `--privileged` due to ability to create nested containers and have full read/write access to `sysfs` (for bind/unbind). Docker automatically pick free network port (`--publish-all`) for ability to connect over ssh. To be able to limit access to PCI bus, container is creating `tmpfs` mount type in PCI bus tree. CSIT reservation script is dynamically linking only PCI devices (NIC cards) that are reserved for particular container. This way it is not colliding with other containers. To make `vfi` work, access to `/dev/vfi` must be granted.

### 4.3.5 Environment initialization

All 1-node servers are to be managed and provisioned via the [\[ansiblelink\]](#) (page 908) set of playbooks with `vpp-device` role. Full playbooks can be found under [\[fdiocsitansible\]](#) (page 908) directory. This way we are able to track all configuration changes of physical servers in gerrit (in structured yaml format) as well as we are able to extend `vpp-device` to additional servers with less effort or re-stage servers in case of failure.

SR-IOV VF initialization is done via `systemd` service during host system boot up. Service with name `csit-initialize-vfs.service` is created under `systemd` system context (`/etc/systemd/system/`). By default service is calling `/usr/local/bin/csit-initialize-vfs.sh` with single parameter:

- **start:** Creates maximum number of VIRTUAL FUNCTIONS (VFs) (detected from `sriov_totalvfs`) for each whitelisted PCI device.
- **stop:** Removes all VFs for all whitelisted PCI device.

Service is considered active even when all of its processes exited successfully. Stopping service will automatically remove VFs.

```
[Unit]
Description=CSIT Initialize SR-IOV VFs
After=network.target

[Service]
Type=one-shot
RemainAfterExit=True
ExecStart=/usr/local/bin/csit-initialize-vfs.sh start
ExecStop=/usr/local/bin/csit-initialize-vfs.sh stop

[Install]
WantedBy=default.target
```

Script is driven by two array variables `pci_blacklist`/`pci_whitelist`. They MUST store all PCI addresses in `<domain>:<bus>:<device>.<func>` format, where:

- **pci\_blacklist:** PCI addresses to be skipped from VFs initialization (usefull for e.g. excluding management network interfaces).
- **pci\_whitelist:** PCI addresses to be included for VFs initialization.

### 4.3.6 VF reservation

During topology initialization phase of script, `mutex` is used to avoid multiple instances of script to interact with each other during resources allocation. Mutal exclusion ensure that no two distinct instances of script will get same resource list.

Reservation function reads the list of all available virtual function network devices in system:

```
net_path="/sys/bus/pci/devices/*/net/*"

for netdev in \
  $(find ${net_path} -type d -name . -o -prune -exec basename '{}' ' ');
do
  if grep -q "${pci_id}" "/sys/class/net/${netdev}/device/device"; then
    # found VF
  fi
done
```

Where `${pci_id}` is ID of white-listed VF PCI ID. For more information please see [\[pciids\]](#) (page 908). This act as security constraint to prevent taking other unwanted interfaces. The output list of all VF network devices is split into two lists for TG and SUT side of connection. First two items from each TG or SUT network devices list are taken to expose directly to namespace of container. This can be done via commands:

```
$ ip link set ${netdev} netns ${DCR_CPIDS[tg]}
$ ip link set ${netdev} netns ${DCR_CPIDS[dut1]}
```

In this stage also symbolic links to PCI devices under sysfs bus directory tree are created in running containers. Once VF devices are assigned to container namespace and PCI devices are linked to running containers and mutex is exited. Selected VF network device automatically disappears from parent container namespace, so another instance of script will not find device under that namespace.

Once Docker container exits, network device is returned back into parent namespace and can be reused.

### 4.3.7 Network traffic isolation - Intel i40evf

In a virtualized environment, on Intel(R) Server Adapters that support SR-IOV, the virtual function (VF) may be subject to malicious behavior. Software-generated layer two frames, like IEEE 802.3x (link flow control), IEEE 802.1Qbb (priority based flow-control), and others of this type, are not expected and can throttle traffic between the host and the virtual switch, reducing performance. To resolve this issue, configure all SR-IOV enabled ports for VLAN tagging. This configuration allows unexpected, and potentially malicious, frames to be dropped. [\[inteli40e\]](#) (page 908)

To configure VLAN tagging for the ports on an SR-IOV enabled adapter, use the following command. The VLAN configuration SHOULD be done before the VF driver is loaded or the VM is booted. [\[inteli40e\]](#) (page 908)

```
$ ip link set dev <PF netdev id> vf <id> vlan <vlan id>
```

For example, the following instructions will configure PF eth0 and the first VF on VLAN 10.

```
$ ip link set dev eth0 vf 0 vlan 10
```

VLAN Tag Packet Steering allows to send all packets with a specific VLAN tag to a particular SR-IOV virtual function (VF). Further, this feature allows to designate a particular VF as trusted, and allows that trusted VF to request selective promiscuous mode on the Physical Function (PF). [\[inteli40e\]](#) (page 908)

To set a VF as trusted or untrusted, enter the following command in the Hypervisor:

```
$ ip link set dev eth0 vf 1 trust [on|off]
```

Once the VF is designated as trusted, use the following commands in the VM to set the VF to promiscuous mode. [\[inteli40e\]](#) (page 908)

- For promiscuous all:

```
$ ip link set eth2 promisc on
```

- For promiscuous Multicast:

```
$ ip link set eth2 allmulti on
```

**Note:** By default, the ethtool priv-flag `vf-true-promisc-support` is set to `off`, meaning that promiscuous mode for the VF will be limited. To set the promiscuous mode for the VF to true promiscuous and allow the VF to see all ingress traffic, use the following command. `$ ethtool set-priv-flags p261p1 vf-true-promisc-support on` The `vf-true-promisc-support` priv-flag does not enable promiscuous mode; rather, it designates which type of promiscuous mode (limited or true) you will get when you enable promiscuous mode using the ip link commands above. Note that this is a global setting that affects the entire device. However, the `vf-true-promisc-support` priv-flag is only exposed to the first PF of the device. The PF remains in limited promiscuous mode (unless it is in MFP mode) regardless of the `vf-true-promisc-support` setting. [intel40e] (page 908)

Service described earlier `csit-initialize-vfs.service` is responsible for assigning 802.1Q vlan tagging to each virtual function via physical function from list of white-listed PCI addresses by following (simplified) code.

```
pci_idx=0
for pci_addr in ${pci_whitelist[@]}; do
  pci_path="/sys/bus/pci/devices/${pci_addr}"
  pf=$(basename "${pci_path}"/net/*)
  for vf in $(seq "${sriov_totalvfs}"); do
    # PCI address index in array (pairing siblings).
    vlan_pf_idx=$(( pci_idx % (${#pci_whitelist[@]} / 2 ))
    # 802.1Q base offset.
    vlan_bs_off=1100
    # 802.1Q PF PCI address offset.
    vlan_pf_off=$(( vlan_pf_idx * 100 + vlan_bs_off ))
    # 802.1Q VF PCI address offset.
    vlan_vf_off=$(( vlan_pf_off + vf - 1 ))
    # VLAN string.
    vlan_str="vlan ${vlan_vf_off}"
    # MAC string.
    mac5=$(printf '%x' ${pci_idx})
    mac6=$(printf '%x' $(( vf - 1 )))
    mac_str="mac ba:dc:0f:fe:${mac5}:${mac6}"
    # Set 802.1Q VLAN id and MAC address
    ip link set ${pf} vf $(( vf - 1 )) ${mac_str} ${vlan_str}
    ip link set ${pf} vf $(( vf - 1 )) trust on
    ip link set ${pf} vf $(( vf - 1 )) spoof off
  done
  pci_idx=$(( pci_idx + 1 ))
done
```

Assignment starts at VLAN 1100 and incrementing by 1 for each VF and by 100 for each white-listed PCI address up to the middle of the PCI list. Second half of the lists is assumed to be directly (cable) paired siblings and assigned with same 802.1Q VLANs as its siblings.

### 4.3.8 Open tasks

#### Security

**Note:** Switch to non-privileged containers: As of now all three container flavors are using privileged containers to make it working. Explore options to switch containers to non-privileged with explicit rather implicit privileges.

---

**Note:** Switch to testuser account instead of root.

---

### Maintainability

---

**Note:** Docker image distribution: Create Jenkins jobs with full pipeline of CI/CD for CSIT Docker images.

---

### Stability

---

**Note:** Implement queueing mechanism: Currently there is no mechanics that would place starving jobs in queue in case of no resources available.

---

---

**Note:** Replace reservation script with Docker network plugin written in GOLANG/SH/Python - platform independent.

---

### 4.3.9 Links

## 4.4 Documentation

CSIT VPP Device Tests Documentation<sup>173</sup> contains detailed functional description and input parameters for each test case.

---

<sup>173</sup> <https://docs.fd.io/csit/rls1901/doc/tests.vpp.device.html>



### 5.1 Overview

#### 5.1.1 Virtual Topologies

CSIT VPP functional tests are executed in VM-based virtual topologies created on demand using VIRL (Virtual Internet Routing Lab) simulation platform contributed by Cisco. VIRL runs on physical baremetal servers hosted by LF FD.io project. Based on the packet path thru SUT VMs, two distinct logical topology types are used for VPP DUT data plane testing:

1. vNIC-to-vNIC switching topologies.
2. Nested-VM service switching topologies.

#### vNIC-to-vNIC Switching

The simplest virtual topology for software data plane application like VPP is vNIC-to-vNIC switching. Tested virtual topologies for 2-Node and 3-Node testbeds are shown in figures below.

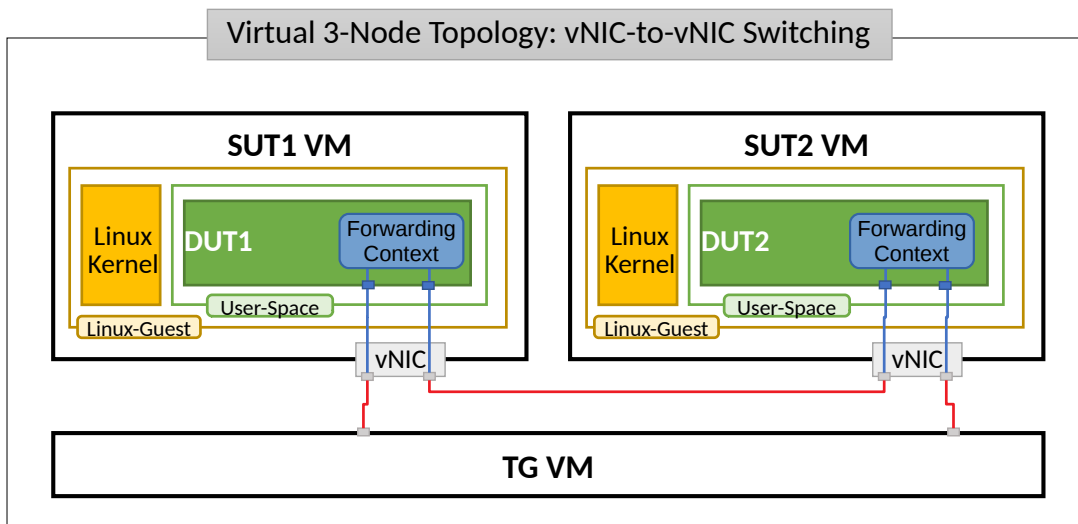
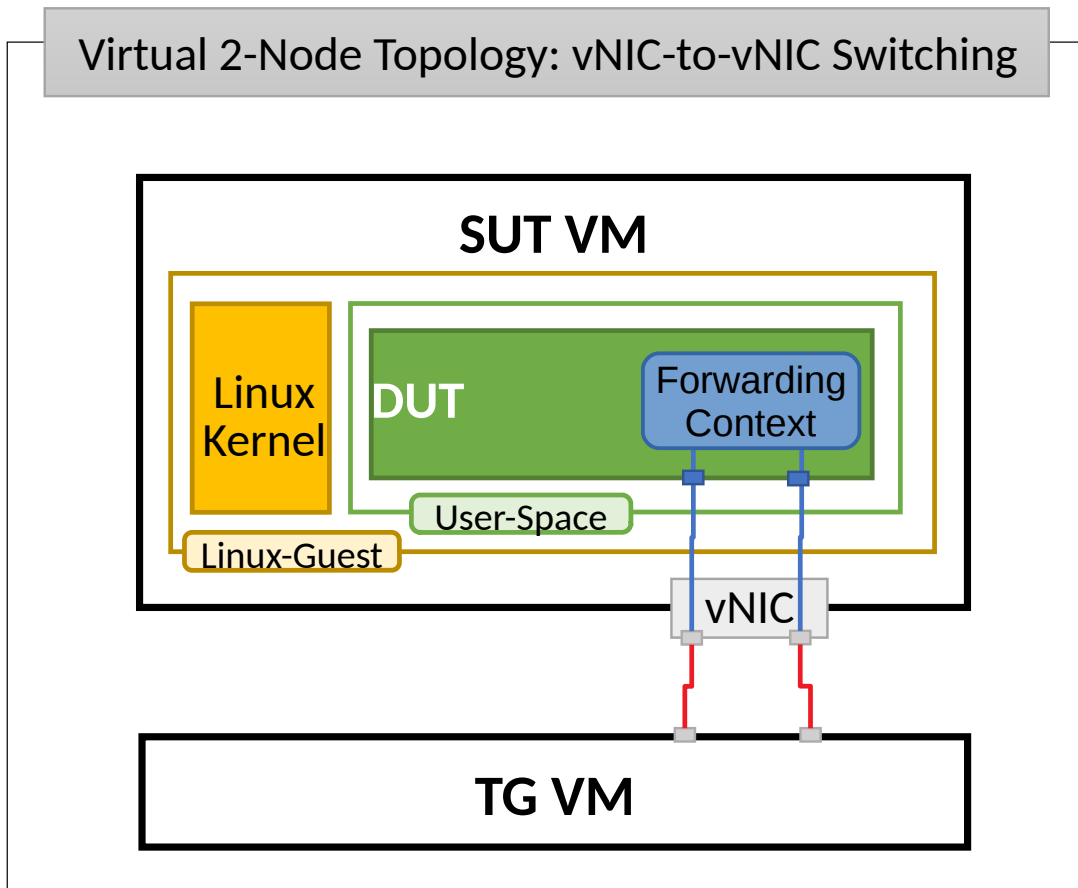

SUT1 and SUT2 are two VMs (running Ubuntu or Centos, depending on the test suite), TG is a Traffic Generator (running Ubuntu VM). SUTs run VPP SW application in Linux user-mode as a Device Under Test (DUT) within the VM. TG runs Scapy SW application as a packet Traffic Generator. Network connectivity between SUTs and to TG is provided using virtual NICs and VMs' virtio drivers.

Virtual testbeds are created on-demand whenever a verification job is started (e.g. triggered by the Gerrit patch submission) and destroyed upon completion of all functional tests. Each node is a Virtual Machine and each connection that is drawn on the diagram is available for use in any test case. During the test execution, all nodes are reachable thru the Management network connected to every node via dedicated virtual NICs and virtual links (not shown above for clarity).

### Nested-VM Service Switching

Nested-VM (Virtual Machine) service switching topology test cases require VPP DUT to communicate with nested-VM(s) over vhost-user virtual interfaces. Nested-VM(s) is(are) created on SUT1 and/or SUT2 for the duration of these particular test cases only. Virtual test topology with nested-VM(s) is shown in the figure below.

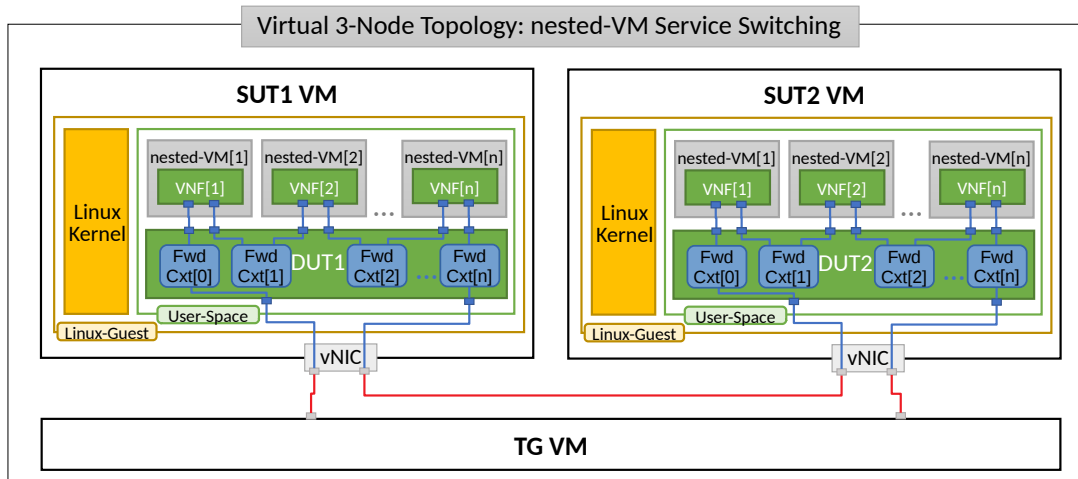

### 5.1.2 Functional Tests Coverage

CSIT-1901 includes following VPP functionality tested in virtual VM environment:

Functionality	Description
ACL	Ingress Access Control List security for L2 Bridge-Domain MAC switching, IPv4 routing, IPv6 routing.
COP	COP address white-list and black-list filtering for IPv4 and IPv6 routing.
DHCP	Dynamic Host Control Protocol Client and Proxy for IPv4 and IPv6 routing.
GRE	Generic Routing Encapsulation Overlay Tunnels for IPv4.
IPSec	IPSec tunnel and transport modes.
IPv4	IPv4 routing, RPF, ARP, Proxy ARP, ICMPv4.
IPv6	IPv6 routing, NS/ND, RA, ICMPv6.
L2BD	L2 Bridge-Domain switching for untagged Ethernet, dot1q and dot1ad tagged.
L2XC	L2 Cross-Connect switching for untagged Ethernet, dot1q and dot1ad tagged.
LISP	Locator/ID Separation Protocol overlay tunnels and locator/id mapping control.
QoS Policer Metering	Ingress packet rate metering and marking for IPv4, IPv6.
Softwire Tunnels	IPv4-in-IPv6 softwire tunnels.
Tap Interface	Baseline Linux tap interface tests.
IPFIX and SPAN	Telemetry IPFIX netflow statistics and SPAN port mirroring.
uRPF Source Security	Unicast Reverse Path Forwarding security for IPv4 and IPv6 routing.
VLAN Tag Translation	L2 VLAN tag translation 2to2, 2to1, 1to2, 1to1.
VRF Routing	Multi-context VRF IPVPN routing for IPv4 and IPv6.
VXLAN	VXLAN overlay tunneling for L2-over-IPv4 and -over-IPv6.

### 5.1.3 Functional Tests Naming

CSIT-1901 follows a common structured naming convention for all performance and system functional tests, introduced in CSIT-17.01.

The naming should be intuitive for majority of the tests. Complete description of CSIT test naming convention is provided on *Test Naming* (page 864).

## 5.2 Release Notes

### 5.2.1 Changes in CSIT-1901

#### 1. TEST FRAMEWORK

- **Bug fixes.**

#### 2. CSIT TEST MIMGRATION

- **VPP\_Path:** Continuing migration of the original FD.io CSIT VIRT tests to VPP-make\_test VPP integration tests for functional acceptance of VPP feature path(s) driven by use case(s). See P1 and P2 markup in [CSIT\\_VIRT migration progress](#)<sup>174</sup>

### 5.2.2 Known Issues

List of known issues in CSIT-1901 for VPP functional tests in VIRT:

#	JiraID	Issue Description
1	<a href="#">CSIT-129</a> <sup>175</sup> <a href="#">VPP-99</a> <sup>176</sup>	DHCPv4 client: Client responses to DHCPv4 OFFER sent with different XID. Client replies with DHCPv4 REQUEST message when received DHCPv4 OFFER message with different (wrong) XID.
2	<a href="#">CSIT-398</a> <sup>177</sup> <a href="#">VPP-380</a> <sup>178</sup>	Softwire - MAP-E: Incorrect calculation of IPv6 destination address when IPv4 prefix is 0. IPv6 destination address is wrongly calculated in case that IPv4 prefix is equal to 0 and IPv6 prefix is less than 40.
3	<a href="#">CSIT-399</a> <sup>179</sup> <a href="#">VPP-435</a> <sup>180</sup>	Softwire - MAP-E: Map domain is created when incorrect parameters provided. Map domain is created in case that the sum of suffix length of IPv4 prefix and PSID length is greater than EA bits length. IPv6 destination address contains bits written with PSID over the EA-bit length when IPv4 packet is sent.
4	<a href="#">CSIT-409</a> <sup>181</sup> <a href="#">VPP-406</a> <sup>182</sup>	IPv6 RA: Incorrect IPv6 destination address in response to ICMPv6 Router Solicitation. Wrong IPv6 destination address (ff02::1) is used in ICMPv6 Router Advertisement packet sent as a response to received ICMPv6 Router Solicitation packet.
5	<a href="#">CSIT-565</a> <sup>183</sup>	Vhost-user: QEMU reconnect does not work. QEMU 2.5.0 used in CSIT does not support vhost-user reconnect. Requires upgrading CSIT VIRT environment to QEMU 2.7.0.
6	<a href="#">CSIT-1371</a> <sup>184</sup>	Softwire: Exclude all softwire functional tests until KWs re-worked to PAPI Map commands were remove from VAT by VPP patch <a href="https://gerrit.fd.io/r/#/c/16115/">https://gerrit.fd.io/r/#/c/16115/</a> .

<sup>174</sup> [https://docs.google.com/spreadsheets/d/1PciV8XN9v1qHblRUpFJoqyES29\\_vik7lcFDI73G1usc/edit?usp=sharing](https://docs.google.com/spreadsheets/d/1PciV8XN9v1qHblRUpFJoqyES29_vik7lcFDI73G1usc/edit?usp=sharing)

<sup>175</sup> <https://jira.fd.io/browse/CSIT-129>

<sup>176</sup> <https://jira.fd.io/browse/VPP-99>

<sup>177</sup> <https://jira.fd.io/browse/CSIT-398>

<sup>178</sup> <https://jira.fd.io/browse/VPP-380>

<sup>179</sup> <https://jira.fd.io/browse/CSIT-399>

<sup>180</sup> <https://jira.fd.io/browse/VPP-435>

<sup>181</sup> <https://jira.fd.io/browse/CSIT-409>

<sup>182</sup> <https://jira.fd.io/browse/VPP-406>

<sup>183</sup> <https://jira.fd.io/browse/CSIT-565>

<sup>184</sup> <https://jira.fd.io/browse/CSIT-1371>

## 5.3 Test Environment

CSIT VPP functional tests are executed in FD.io VIRL testbeds. The physical VIRL testbed infrastructure consists of three VIRL servers:

- tb4-vir1:
  - Status: Production
  - OS: Ubuntu 16.04.2
  - VIRL STD server version: 0.10.32.16
  - VIRL UWM server version: 0.10.32.16
- tb4-vir2:
  - Status: Production
  - OS: Ubuntu 16.04.2
  - VIRL STD server version: 0.10.32.16
  - VIRL UWM server version: 0.10.32.16
- tb4-vir3:
  - Status: Production
  - OS: Ubuntu 16.04.2
  - VIRL STD server version: 0.10.32.19
  - VIRL UWM server version: 0.10.32.19
- VIRL hosts: Cisco UCS C240-M4, each with 2x Intel Xeon E5-2699 v3 (2.30 GHz, 18c), 512GB RAM.

Whenever a patch is submitted to gerrit for review, parallel VIRL simulations are started to reduce the time of execution of all functional tests. The number of parallel VIRL simulations is equal to a number of test groups defined by TEST\_GROUPS variable in `csit/bootstrap.sh` file. VIRL host to run VIRL simulation is selected based on least load algorithm per VIRL simulation.

Every VIRL simulation uses the same three-node logical ring topology - Traffic Generator (TG node) and two Systems Under Test (SUT1 and SUT2). The appropriate pre-built VPP packages built by Jenkins for the patch under review are then installed on the two SUTs, along with their `/etc/vpp/startup.conf` file, in all VIRL simulations.

### 5.3.1 SUT Settings - VIRL Guest VM

SUT VMs' settings are defined in [VIRL topologies directory](#)<sup>185</sup>

- List of SUT VM interfaces:

```
<interface id="0" name="GigabitEthernet0/4/0"/> <interface id="1"
name="GigabitEthernet0/5/0"/> <interface id="2" name="GigabitEthernet0/6/0"/>
<interface id="3" name="GigabitEthernet0/7/0"/>
```
- Number of 2MB hugepages: 1024.
- Maximum number of memory map areas: 20000.
- Kernel Shared Memory Max:  $2147483648$  ( $vm.nr\_hugepages * 2 * 1024 * 1024$ ).

<sup>185</sup> <https://git.fd.io/csit/tree/resources/tools/virl/topologies/?h=rls1901>

### 5.3.2 SUT Settings - VIRL Guest OS Linux

In CSIT terminology, the VM operating system for both SUTs that VPP-19.01 release has been tested with, is the following:

#### 1. Ubuntu VIRL image

This image implies Ubuntu 16.04.1 LTS, current as of yyyy-mm-dd (that is, package versions are those that would have been installed by a `apt-get update`, `apt-get upgrade` on that day), produced by CSIT disk image build scripts.

The exact list of installed packages and their versions (including the Linux kernel package version) are included in [VIRL ubuntu images lists](#)<sup>186</sup>.

A replica of this VM image can be built by running the `build.sh` script in CSIT repository.

#### 2. CentOS VIRL image

This image implies Centos 7.4-1711, current as of yyyy-mm-dd (that is, package versions are those that would have been installed by a `yum update`, `yum upgrade` on that day), produced by CSIT disk image build scripts.

The exact list of installed packages and their versions (including the Linux kernel package version) are included in [VIRL centos images lists](#)<sup>187</sup>.

A replica of this VM image can be built by running the `build.sh` script in CSIT repository.

#### 3. Nested VM image

In addition to the “main” VM image, tests which require VPP to communicate to a VM over a vhost-user interface, utilize a “nested” VM image.

This “nested” VM is dynamically created and destroyed as part of a test case, and therefore the “nested” VM image is optimized to be small, lightweight and have a short boot time. The “nested” VM image is not built around any established Linux distribution, but is based on [BuildRoot](#)<sup>188</sup>, a tool for building embedded Linux systems. Just as for the “main” image, scripts to produce an identical replica of the “nested” image are included in CSIT GIT repository, and the image can be rebuilt using the “build.sh” script at [VIRL nested](#)<sup>189</sup>.

### 5.3.3 DUT Settings - VPP

Every System Under Test runs VPP SW application in Linux user-mode as a Device Under Test (DUT) node.

#### DUT Port Configuration

Port configuration of DUTs is defined in topology file that is generated per VIRL simulation based on the definition stored in [VIRL topologies directory](#)<sup>190</sup>.

Example of DUT nodes configuration:

```
DUT1:
  type: DUT
  host: "10.30.51.157"
  arch: x86_64
  port: 22
  username: cisco
  honeycomb:
    user: admin
```

(continues on next page)

<sup>186</sup> <https://git.fd.io/csit/tree/resources/tools/disk-image-builder/ubuntu/lists/?h=rls1901>

<sup>187</sup> <https://git.fd.io/csit/tree/resources/tools/disk-image-builder/centos/lists/?h=rls1901>

<sup>188</sup> <https://buildroot.org/>

<sup>189</sup> <https://git.fd.io/csit/tree/resources/tools/disk-image-builder/nested/?h=rls1901>

<sup>190</sup> <https://git.fd.io/csit/tree/resources/tools/virl/topologies/?h=rls1901>

(continued from previous page)

```

passwd: admin
port: 8183
netconf_port: 2831
priv_key: |
-----BEGIN RSA PRIVATE KEY-----
MIIEpGIBAAKCAQEAwUDITpzShpwLQotZOFs4AgcPNEwCnP1AB2hWFmvI+8Kah/gb
v8ruZU9RqhPs56tyKzxbhvNkY4VbH5F1GiLHZu3mLqzM4KfghMmaeMEj01T7BYyd
vuBfTvIlu1jfQ2vAlnYrDwn+C1xJk81m0pDgvrLEX4qVVh2sGh7UEKyy5r82DNa2
4VjzPB1J/c8a9zP8FoZUhyIZf4FLvRMjUADpbMXgJMsGpaZLmz95ap0Eot7vb1Cc
1LvF97iyBCrtIOSKRKA50ZHLGjMKmOwnYU+cP5718tbproDVi6VJ0o7zeuXyetMs
8YB19kwb1WG9BqP9jctFvsmi5G7hXgq1Y8u+DwIDAQABoIBAQC/W4E0DHjLMny7
0bvW2YkZD0Zw3fttdB94tkm4PdZv5MybooPnsAvLaXVV0hEdfVi5kzSWN1/LY/tN
EP1BgGphc2QgB59/PPxGwFIjDCvUz1sZpynBHe+B/qh5ExNQCvVsIOqWI7DX1XaN
0i/kh0zmJ6HncRRah1spKimYRsaUUDskyg7q3QqMwVaqBbbMvLs/w7ZWd/zoDqCU
MY/pCI6hkB3QbRo00diZLohphB12ShABTwjvVyyKL5UA4jAeneJrhH5gWVLXnfgD
p62W5CollKEYb1C8mUkPxpP7Qo277zw3xaq+oktIZhc5SUEUd7nJZtNqVAHqkItW
79VmpKyxAoGBAPfU+kqNPaTSvp+x1n5sn2SgipzDtgI9QqNmC4cJtrQqaaqI57SG
OHw1jX8i7L2G1WvVtkHg060n1EVo5n65fff0qeVBezLVJ7ghWI8U+oBiJjyQ4boD
GJVnsoS0UQ0rtuGd9eVwfdk3o19aCn0KK53oPfIYli29pyu4l095kg11AoGBAMef
bPEMBI/2XmCPshLShwGF1+dW8d+K1luj3CUQ/0vU1vma3dfBOYNsIwAgTP0iIUTg
8DYE6KBCdPtXAEUI0YAEAKB9ry1tKR2NQEIPfs1YytKerTwiAiqSi0heM6+zwEzu
f54Z4oBhsMSL0jXoMnu+NZzEc6EUdQeY40+jhjzAoGBAIogC3dtjMPGKTP7+93u
UE/XIioI8fWg9fj3sMka4IMu+pVvRCRbAjRH7JrFLkjbUyuMqs3Arnk9K+gbdQt/
+m95Njtt6WoFXuPCwgbM3GidSmZwYT4454SfDzVBYScedcNm1FuR+8ov9bFLDtGT
D4gsngnGJj1MDFXTxZen4nzZAoGBAKCg4WmpUPaCuXibyB+rZavxwsTNSn2lJ83/
sYJGBhf/raiV/FLDUcM1vYg5dZnu37RsB/5/vqxOLZGyYd7x+Jo5HkQGPnKgNwhn
g8BkdZIRF8uEJqx0o0ycd0U7n/2093swIpKWo5LIiRPuqqzj+uZKnAL7vuVdxfaY
qVz2daMPAoGBALgaaKa3voU/H01PYLWIhFrBThyJ+BQSQ80qrEzC8AnegWfXRAM8
EqrzXl7ACUuo1dH0Eipm41j2+BZWlQjjiUgq5uj8+zyz+EU1ZRRyJcOKzbDACeuD
BpWWSXGBI5G4CppeYLjMUHZpJYeX1USULJQd2c4crLJKb76E8gz3Z9kN
-----END RSA PRIVATE KEY-----

```

## interfaces:

```

port1:
  mac_address: "fa:16:3e:9b:89:52"
  pci_address: "0000:00:04.0"
  link: link1
port2:
  mac_address: "fa:16:3e:7a:33:60"
  pci_address: "0000:00:05.0"
  link: link4
port3:
  mac_address: "fa:16:3e:29:b7:ae"
  pci_address: "0000:00:06.0"
  link: link3
port4:
  mac_address: "fa:16:3e:76:8d:ff"
  pci_address: "0000:00:07.0"
  link: link6

```

## DUT2:

```

type: DUT
host: "10.30.51.156"
arch: x86_64
port: 22
username: cisco
honeypot:
  user: admin
  passwd: admin
  port: 8183
  netconf_port: 2831
priv_key: |

```

(continues on next page)

(continued from previous page)

```

-----BEGIN RSA PRIVATE KEY-----
MIIEPgIABAQCAQEAWUD1TpzSHpwLQotZOFS4AgcPNEWCnP1AB2hWFmvI+8Kah/gb
v8ruZU9RqhPs56tyKzxbhvNkY4VbH5F1Gi1HZu3mLqzM4KfghMmaeMEjO1T7BYyd
vuBfTviLu1jfQ2vA1nYrDwn+C1xJk81m0pDgvrLEX4qVvh2sGh7UEkYy5r82DNa2
4VjzPB1J/c8a9zP8FoZUHYIZf4FLvRMjUADpbMXgJMsGpaZLmz95ap0Eot7vb1Cc
1LvF97iyBCrtIOSKRKA50ZHLGjMKmOwnYU+cP5718tbproDVi6VJ0o7zeuXyetMs
8YB19kwb1WG9BqP9jctFvsmi5G7hXgq1Y8u+DwIDAQABAoIBAQC/W4E0DHjLMny7
0bvW2YkZD0Zw3fttdB94tkm4PdZv5MybooPnsAvLaXVv0hEdfVi5kzSWN1/LY/tN
EP1BgGphc2QgB59/PPxGwFIjDcVuz1sZpynBHe+B/qh5ExNQcVvsIQWI7DX1XaN
0i/kh0zJ6HncRRah1spKimYRsaUUDskyg7q3QqMwVaqBbbMvLs/w7ZWd/zoDqCU
MY/pCI6hkB3QbRo00diZLohphB12ShABTwjvVyyKL5UA4jAeneJrhH5gWVLXnfgD
p62W5Col1KEYblC8mUkPxpP7Qo277zw3xaq+oktIZhc5SUEud7nJZtNqVAHqkItW
79VmpKyxAoGBAPFuf+kNPaTSvp+x1n5sn2SgipzDtgi9QqNmC4cjrQQaaqI57SG
OHw1jX8i7L2G1WvVtkHg060n1EVo5n65fff0qeVBezLVJ7ghWI8U+oBiJJyQ4boD
GJVNs0oSUQ0rtuGd9eVwfDk3o19aCN0KK53oPfIY1i29pyu4l095kg11AoGBAMef
bPEMBI/2XmCPshLswHGF1+dW8d+K1luj3CUQ/0vU1vma3dfBOYNsIwAgTP0iIUTg
8DYEK6KBCPtXAEI0YAEAKB9ry1tKR2NQEIPfs1YytKErtwjAiQSi0heM6+zwEzu
f54Z4oBhsMSL0jXoMnu+NZzEc6EUdQeY40+jhjzAoGBAIOgC3dtjMPGKTP7+93u
UE/XIioI8fWg9fj3sMka4IMu+pVvRCRbAjRH7JrFLkjbUyuMqs3Arnk9K+gbdQt/
+m95Njtt6WoF XuPCwgbM3GidSmZwYT4454SfDzVBYScedcNm1FuR+8ov9bFLDtGT
D4gsngnGj1MDFXTxZEn4nzZAoGBAKCg4WmpUPaCuXibyB+rZavxwsTNSn2lJ83/
sYJGBhf/raiv/FLDUcM1vYg5dZnu37RsB/5/vqx0LZGyYd7x+Jo5HKQGpNkgNwhn
g8BkZIRF8uEJqx0o0yc0U7n/2093swIpkWo5LIiRPuqqzj+uZKnAL7vuVdxfaY
qVz2daMPAoGBALgaaKa3voU/H01PYLWIhFrBThyJ+BQSQ80qrEzC8AnegWFxRAM8
EqrzX17ACUuo1dH0Eipm41j2+BZWlQjiUgq5uj8+zyz+EU1ZRRyJcOKzbDACeuD
BpWWSXGBI5G4CppeYLjMUHZpJYeX1USULJQd2c4crLJKb76E8gz3Z9kN
-----END RSA PRIVATE KEY-----

interfaces:
port1:
  mac_address: "fa:16:3e:ad:6c:7d"
  pci_address: "0000:00:04.0"
  link: link2
port2:
  mac_address: "fa:16:3e:94:a4:99"
  pci_address: "0000:00:05.0"
  link: link5
port3:
  mac_address: "fa:16:3e:75:92:da"
  pci_address: "0000:00:06.0"
  link: link3
port4:
  mac_address: "fa:16:3e:2c:b1:2a"
  pci_address: "0000:00:07.0"
  link: link6

```

### VPP Version

VPP-19.01 release

### VPP Installed Packages - Ubuntu

```

Desired=Unknown/Install/Remove/Purge/Hold
| Status=Not/Inst/Conf-files/Unpacked/half-conf/Half-inst/trig-aWait/Trig-pend
|/ Err?=(none)/Reinst-required (Status,Err: uppercase=bad)
||/ Name          Version          Architecture Description
+++-----
ii vpp             19.01-release   amd64          Vector Packet Processing--executables

```

(continues on next page)



(continued from previous page)

ii	vpp-api-python	19.01-release	amd64	VPP Python API bindings
ii	vpp-dbg	19.01-release	amd64	Vector Packet Processing--debug symbols
ii	vpp-dev	19.01-release	amd64	Vector Packet Processing--development support
ii	vpp-lib	19.01-release	amd64	Vector Packet Processing--runtime libraries
ii	vpp-plugins	19.01-release	amd64	Vector Packet Processing--runtime plugins

### VPP Installed Packages - Centos

```

$ rpm -qai vpp*
Name       : vpp-selinux-policy
Version    : 19.01
Release    : release
Architecture: x86_64
Install Date: Thu 31 Jan 2019 07:16:34 AM EST
Group      : System Environment/Base
Size       : 102213
License    : ASL 2.0
Signature  : (none)
Source RPM : vpp-19.01-release.src.rpm
Build Date : Wed 30 Jan 2019 06:04:06 PM EST
Build Host : ed28282db47e
Relocations : (not relocatable)
Summary    : VPP Security-Enhanced Linux (SELinux) policy
Description :
This package contains a tailored VPP SELinux policy
Name       : vpp-plugins
Version    : 19.01
Release    : release
Architecture: x86_64
Install Date: Thu 31 Jan 2019 07:16:37 AM EST
Group      : System Environment/Libraries
Size       : 84873573
License    : ASL 2.0
Signature  : (none)
Source RPM : vpp-19.01-release.src.rpm
Build Date : Wed 30 Jan 2019 06:04:06 PM EST
Build Host : ed28282db47e
Relocations : (not relocatable)
Summary    : Vector Packet Processing--runtime plugins
Description :
This package contains VPP plugins
Name       : vpp-api-python
Version    : 19.01
Release    : release
Architecture: x86_64
Install Date: Thu 31 Jan 2019 07:16:34 AM EST
Group      : Development/Libraries
Size       : 163624
License    : ASL 2.0
Signature  : (none)
Source RPM : vpp-19.01-release.src.rpm
Build Date : Wed 30 Jan 2019 06:04:06 PM EST
Build Host : ed28282db47e
Relocations : (not relocatable)
Summary    : VPP api python bindings
Description :
This package contains the python bindings for the vpp api
Name       : vpp
Version    : 19.01

```

(continues on next page)

(continued from previous page)

```

Release      : release
Architecture: x86_64
Install Date: Thu 31 Jan 2019 07:16:34 AM EST
Group       : Unspecified
Size        : 2522340
License     : ASL 2.0
Signature   : (none)
Source RPM  : vpp-19.01-release.src.rpm
Build Date  : Wed 30 Jan 2019 06:04:06 PM EST
Build Host  : ed28282db47e
Relocations : (not relocatable)
Summary     : Vector Packet Processing
Description :
This package provides VPP executables: vpp, vpp_api_test, vpp_json_test
vpp - the vector packet engine
vpp_api_test - vector packet engine API test tool
vpp_json_test - vector packet engine JSON test tool
Name        : vpp-lib
Version     : 19.01
Release    : release
Architecture: x86_64
Install Date: Thu 31 Jan 2019 07:16:34 AM EST
Group       : System Environment/Libraries
Size        : 12203613
License     : ASL 2.0
Signature   : (none)
Source RPM  : vpp-19.01-release.src.rpm
Build Date  : Wed 30 Jan 2019 06:04:06 PM EST
Build Host  : ed28282db47e
Relocations : (not relocatable)
Summary     : VPP libraries
Description :
This package contains the VPP shared libraries, including:
vppinfra - foundation library supporting vectors, hashes, bitmaps, pools, and string formatting.
svm - vm library
vlib - vector processing library
vlib-api - binary API library
vnet - network stack library
Name        : vpp-devel
Version     : 19.01
Release    : release
Architecture: x86_64
Install Date: Thu 31 Jan 2019 07:16:38 AM EST
Group       : Development/Libraries
Size        : 12835399
License     : ASL 2.0
Signature   : (none)
Source RPM  : vpp-19.01-release.src.rpm
Build Date  : Wed 30 Jan 2019 06:04:06 PM EST
Build Host  : ed28282db47e
Relocations : (not relocatable)
Summary     : VPP header files, static libraries
Description :
This package contains the header files for VPP.
Install this package if you want to write a
program for compilation and linking with vpp lib.
vlib
vlibmemory
vnet - devices, classify, dhcp, ethernet flow, gre, ip, etc.
vpp-api
vppinfra

```

## VPP Startup Configuration

VPP startup configuration is common for all test cases except test cases related to SW Crypto device.

### Common Configuration

```
$ cat /etc/vpp/startup.conf
unix {
    nodaemon
    log /var/log/vpp/vpp.log
    full-coredump
    cli-listen /run/vpp/cli.sock
    gid vpp
}

api-trace {
    ## This stanza controls binary API tracing. Unless there is a very strong reason,
    ## please leave this feature enabled.
    on
    ## Additional parameters:
    ##
    ## To set the number of binary API trace records in the circular buffer, configure nitems
    ##
    ## nitems <nnn>
    ##
    ## To save the api message table decode tables, configure a filename. Results in /tmp/<filename>
    ## Very handy for understanding api message changes between versions, identifying missing
    ## plugins, and so forth.
    ##
    ## save-api-table <filename>
}

api-segment {
    gid vpp
}

socksvr {
    default
}

cpu {
    ## In the VPP there is one main thread and optionally the user can create worker(s)
    ## The main thread and worker thread(s) can be pinned to CPU core(s) manually or automatically

    ## Manual pinning of thread(s) to CPU core(s)

    ## Set logical CPU core where main thread runs, if main core is not set
    ## VPP will use core 1 if available
    # main-core 1

    ## Set logical CPU core(s) where worker threads are running
    # corelist-workers 2-3,18-19

    ## Automatic pinning of thread(s) to CPU core(s)

    ## Sets number of CPU core(s) to be skipped (1 ... N-1)
    ## Skipped CPU core(s) are not used for pinning main thread and working thread(s).
    ## The main thread is automatically pinned to the first available CPU core and worker(s)
    ## are pinned to next free CPU core(s) after core assigned to main thread
    # skip-cores 4

    ## Specify a number of workers to be created
    ## Workers are pinned to N consecutive CPU cores while skipping "skip-cores" CPU core(s)
}
```

(continues on next page)

(continued from previous page)

```

## and main thread's CPU core
# workers 2

## Set scheduling policy and priority of main and worker threads

## Scheduling policy options are: other (SCHED_OTHER), batch (SCHED_BATCH)
## idle (SCHED_IDLE), fifo (SCHED_FIFO), rr (SCHED_RR)
# scheduler-policy fifo

## Scheduling priority is used only for "real-time policies (fifo and rr),
## and has to be in the range of priorities supported for a particular policy
# scheduler-priority 50
}

# dpdk {
## Change default settings for all interfaces
# dev default {
## Number of receive queues, enables RSS
## Default is 1
# num-rx-queues 3

## Number of transmit queues, Default is equal
## to number of worker threads or 1 if no workers threads
# num-tx-queues 3

## Number of descriptors in transmit and receive rings
## increasing or reducing number can impact performance
## Default is 1024 for both rx and tx
# num-rx-desc 512
# num-tx-desc 512

## VLAN strip offload mode for interface
## Default is off
# vlan-strip-offload on
# }

## Whitelist specific interface by specifying PCI address
# dev 0000:02:00.0

## Blacklist specific device type by specifying PCI vendor:device
## Whitelist entries take precedence
# blacklist 8086:10fb

## Set interface name
# dev 0000:02:00.1 {
#     name eth0
# }

## Whitelist specific interface by specifying PCI address and in
## addition specify custom parameters for this interface
# dev 0000:02:00.1 {
#     num-rx-queues 2
# }

## Specify bonded interface and its slaves via PCI addresses
##
## Bonded interface in XOR load balance mode (mode 2) with L3 and L4 headers
# vdev eth_bond0,mode=2,slave=0000:02:00.0,slave=0000:03:00.0,xmit_policy=l34
# vdev eth_bond1,mode=2,slave=0000:02:00.1,slave=0000:03:00.1,xmit_policy=l34
##
## Bonded interface in Active-Back up mode (mode 1)

```

(continues on next page)

(continued from previous page)

```

# vdev eth_bond0,mode=1,slave=0000:02:00.0,slave=0000:03:00.0
# vdev eth_bond1,mode=1,slave=0000:02:00.1,slave=0000:03:00.1

## Change UIO driver used by VPP, Options are: igb_uio, vfio-pci,
## uio_pci_generic or auto (default)
# uio-driver vfio-pci

## Disable multi-segment buffers, improves performance but
## disables Jumbo MTU support
# no-multi-seg

## Increase number of buffers allocated, needed only in scenarios with
## large number of interfaces and worker threads. Value is per CPU socket.
## Default is 16384
# num-mbufs 128000

## Change hugepages allocation per-socket, needed only if there is need for
## larger number of mbufs. Default is 256M on each detected CPU socket
# socket-mem 2048,2048

## Disables UDP / TCP TX checksum offload. Typically needed for use
## faster vector PMDs (together with no-multi-seg)
# no-tx-checksum-offload
# }

# plugins {
## Adjusting the plugin path depending on where the VPP plugins are
#     path /ws/vpp/build-root/install-vpp-native/vpp/lib/vpp_plugins

## Disable all plugins by default and then selectively enable specific plugins
# plugin default { disable }
# plugin dpdk_plugin.so { enable }
# plugin acl_plugin.so { enable }

## Enable all plugins by default and then selectively disable specific plugins
# plugin dpdk_plugin.so { disable }
# plugin acl_plugin.so { disable }
# }

```

## SW Crypto Device Configuration

```

$ cat /etc/vpp/startup.conf
unix
{
  cli-listen /run/vpp/cli.sock
  gid vpp
  nodaemon
  full-coredump
  log /tmp/vpp.log
}
api-segment
{
  gid vpp
}
dpdk
{
  vdev cryptodev_aesni_gcm_pmd,socket_id=0
  vdev cryptodev_aesni_mb_pmd,socket_id=0
}

```

### 5.3.4 TG Settings - Scapy

Traffic Generator node is VM running the same OS Linux as SUTs. Ports of this VM are used as source (Tx) and destination (Rx) ports for the traffic.

Traffic scripts of test cases are executed on this VM.

#### TG VM Configuration

Configuration of the TG VMs is defined in [VIRL topologies directory](#)<sup>191</sup>.

/csit/resources/tools/virl/topologies/double-ring-nested.xenial.virl

- List of TG VM interfaces::

```
<interface id="0" name="eth1"/>
<interface id="1" name="eth2"/>
<interface id="2" name="eth3"/>
<interface id="3" name="eth4"/>
<interface id="4" name="eth5"/>
<interface id="5" name="eth6"/>
```

#### TG Port Configuration

Port configuration of TG is defined in topology file that is generated per VIRL simulation based on the definition stored in [VIRL topologies directory](#)<sup>192</sup>.

Example of TG node configuration::

```
TG:
type: TG
host: "10.30.51.155"
arch: x86_64
port: 22
username: cisco
priv_key: |
-----BEGIN RSA PRIVATE KEY-----
MIIEPgIBAAKCAQEAwUDlTpzShpwLQotZOFS4AgcPNEWCnP1AB2hWFmvI+8Kah/gb
v8ruZU9RqhPs56tyKzxbhvNkY4VbH5F1GiLHZu3mLqzM4KfghMmaeMEj01T7BYyd
vuBftvIlu1jfQ2vAlnYrDwn+ClxJk81m0pDgvrLEX4qVVh2sGh7UEkYy5r82DNa2
4VjzPB1J/c8a9zP8FoZUhYIzF4FLvRMjUADpbMXgJMsGpaZLmz95ap0Eot7vb1Cc
1LvF97iyBCrtIOSKRKA50ZHLGjMKmOwnYU+cP5718tbproDVi6VJ0o7zeuXyetMs
8YB19kWb1WG9BqP9jctFvsmi5G7hXgq1Y8u+DwIDAQABAoIBAQC/W4E0DHjLMny7
0bvW2YkZ0Zw3fttdB94tkm4PdZv5MybooPnsAvLaXVv0hEdfVi5kzSWN1/LY/tN
EP1BgGphc2QgB59/PPxGwFIjDCvUz1sZpynBHe+B/qh5ExNqCvVsIQWI7DX1XaN
0i/kh0zmJ6HncRRah1spKImYRsaUUDskyg7q3QqMwVaqBbbMvLs/w7Zwd/zoDqCU
MY/pCI6hkB3QbRo0odiZLohphB12ShABTjvVyyKL5UA4jAEneJrhH5gWVLXnfgD
p62W5CollKEYb1C8mUkPxpP7Qo277zw3xaq+oktIZhc5SUEUd7nJZtNqVAHqkItW
79VmpKyxAoGBAPfU+kqNPaTSvp+x1n5sn2SgipzDgtgi9QqNmC4cjtrQQaaqI57SG
OHw1jX8i7L2G1WvVtkHg060n1EVo5n65fff0qeVBezLVJ7ghWI8U+oBiJJyQ4boD
GJVnso0SUQ0rtuGd9eVwfdk3o19aCN0KK53oPfIY1i29pyu4l095kg11AoGBAMef
bPEMBI/2XmCPshLswHGF1+dW8d+K1luj3CUQ/0vU1vma3dfBOYNsIwAgTP0iIUTg
8DYE6KBCdPtXAEI0YAEAKB9ry1tKR2NQEIPfs1YytKerTjwAiqSi0heM6+zwEzu
f54Z4oBhsMSL0jXoMnu+NzZec6EUdQeY40+jhjzAoGBAIOgC3dtjMPGKTP7+93u
UE/XIioI8fWg9fj3sMka4IMu+pVvRCRbAjRH7JrFLkjbUyuMqs3Arnk9K+gbdQt/
+m95Njtt6WoFXuPCwgbM3GidSmZwYT4454SfDzVBYScedcNm1FuR+8ov9bFLDtGT
D4gsngnGJj1MDFXTxZEn4nzZAoGBAKCg4WmpUPaCuXibyB+rZavxwstNSn21J83/
sYJGBhf/raiv/FLDUcM1vYg5dZnu37RsB/5/vqx0LZGyYd7x+Jo5HkQGPnKgNwhn
```

(continues on next page)

<sup>191</sup> <https://git.fd.io/csit/tree/resources/tools/virl/topologies/?h=rls1901>

<sup>192</sup> <https://git.fd.io/csit/tree/resources/tools/virl/topologies/?h=rls1901>

(continued from previous page)

```
g8BkdZIRF8uEJqx0o0ycd0U7n/2093swIpKWo5LIiRPuqzj+uZKnAL7vuVdxfaY
qVz2daMPAoGBALgaaKa3voU/H01PYLWIhFrBThyJ+BQSQ80qrEzC8AnegWFxRAM8
EqrzZX17ACUuo1dH0Eipm41j2+BZW1QjiUgq5uj8+zyz+EU1ZRRyJcOKzbDACeuD
BpWWSXGBI5G4CppeYLjMUHZpJYeX1USULJQd2c4crLJKb76E8gz3Z9kN
-----END RSA PRIVATE KEY-----
```

```
interfaces:
```

```
port3:
  mac_address: "fa:16:3e:b9:e1:27"
  pci_address: "0000:00:06.0"
  link: link1
  driver: virtio-pci
port4:
  mac_address: "fa:16:3e:e9:c8:68"
  pci_address: "0000:00:07.0"
  link: link4
  driver: virtio-pci
port5:
  mac_address: "fa:16:3e:e8:d3:47"
  pci_address: "0000:00:08.0"
  link: link2
  driver: virtio-pci
port6:
  mac_address: "fa:16:3e:cf:ca:58"
  pci_address: "0000:00:09.0"
  link: link5
  driver: virtio-pci
```

## Traffic Generator

Functional tests utilize Scapy as a traffic generator. Scapy v2.3.1 is used for VPP-19.01 release tests.

## 5.4 Documentation

[CSIT VPP Functional Tests Documentation](https://docs.fd.io/csit/rls1901/doc/tests.vpp.func.html)<sup>193</sup> contains detailed functional description and input parameters for each test case.

<sup>193</sup> <https://docs.fd.io/csit/rls1901/doc/tests.vpp.func.html>

### 6.1 Overview

#### 6.1.1 Virtual Topologies

CSIT HoneyComb functional tests are executed in VM-based virtual topologies created on demand using VIRT simulation platform contributed by Cisco. VIRT runs on physical baremetal servers hosted by LF FD.io project.

All tests are executed in two-node virtual test topology shown in the figure below.



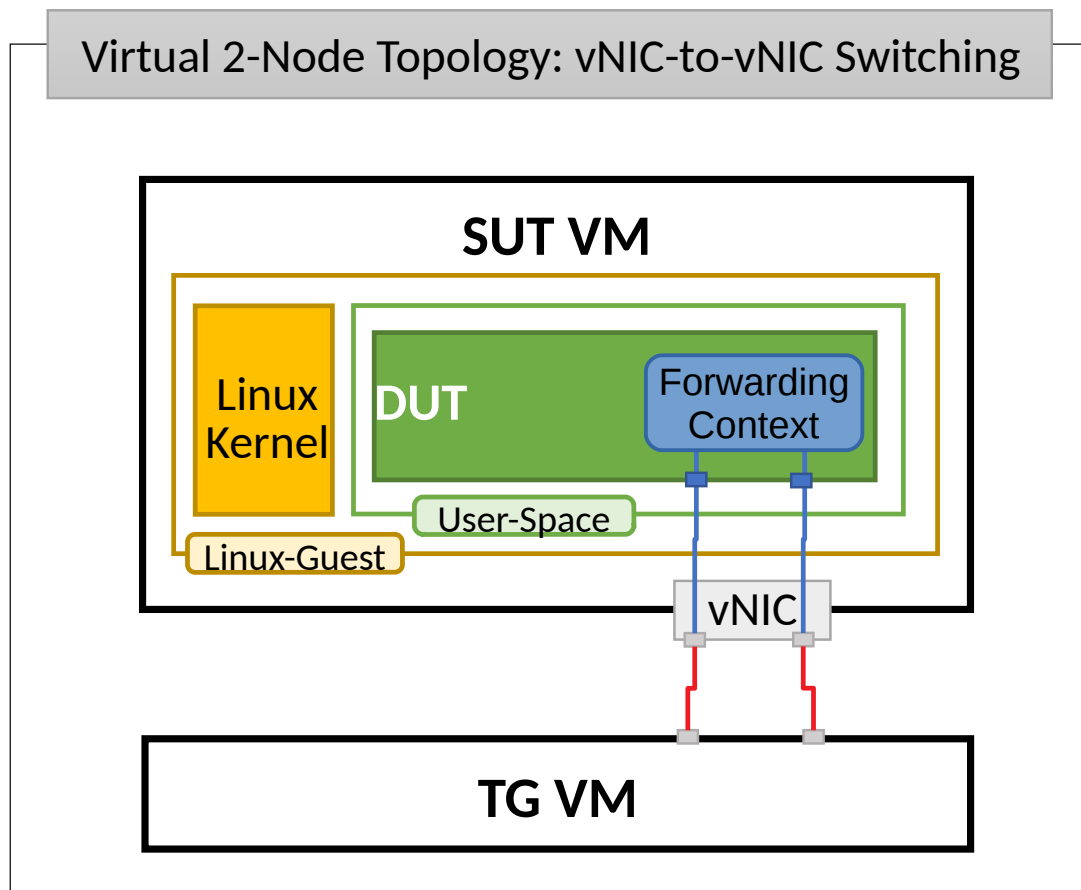

SUT (System Under Test) is a VM running Ubuntu Linux (or Centos, depending on the test suite), TG (Traffic Generator) is another VM running Ubuntu Linux. SUT VMs run HoneyComb management agent and VPP in Linux user-mode as a combined DUT (Device Under Test). TG runs Scapy application as a packet Traffic Generator. Virtual connectivity between SUT and TG is provided using virtual NICs using VMs' virtio drivers.

### 6.1.2 Functional Tests Coverage

CSIT-1901 includes following HoneyComb functionality tested in virtual VM environment:

Functionality	Description
ACL	<ul style="list-style-type: none"> <li>• CRD for low-level classifiers: table and session management, interface assignment.</li> <li>• Configure up to 2 classify tables.</li> <li>• Configure up to 2 classify sessions on one table.</li> <li>• Assign classify session to a physical interface.</li> <li>• Remove tables, sessions, interface assignments.</li> <li>• Test case count: 9.</li> </ul>
ACL-PLUGIN	<ul style="list-style-type: none"> <li>• CRD for high-level classifier.</li> <li>• MAC + IP address classification.</li> <li>• IPv4, IPv6 address classification.</li> <li>• TCP, UDP, ICMP, ICMPv6 protocol and next-header classification.</li> <li>• port number classification.</li> <li>• ICMP, ICMPv6 code and type classification.</li> <li>• Test case count: 15.</li> </ul>
Basic interface management	<ul style="list-style-type: none"> <li>• CRUD for interface state.</li> <li>• ipv4/ipv6 address, ipv4 neighbor, MTU value.</li> <li>• Test case count: 14.</li> </ul>
Border Gateway Protocol	<ul style="list-style-type: none"> <li>• CRUD and functional tests for BGP.</li> <li>• Configure peers and routes</li> <li>• Check interactions with another BGP peer.</li> <li>• Test case count: 13.</li> </ul>
DHCP Relay	<ul style="list-style-type: none"> <li>• CRD for DHCP relay feature.</li> <li>• Configure DHCP Relays.</li> <li>• IPv4 and IPv6 variants.</li> <li>• Test case count: 4.</li> </ul>
Honeycomb Infrastructure	<ul style="list-style-type: none"> <li>• Configuration persistence.</li> <li>• Netconf notifications for interface events.</li> <li>• Netconf negative tests aimed at specific issues.</li> <li>• Netconf/Restconf northbound over IPv6.</li> <li>• Test case count: 14.</li> </ul>
L2BD	<ul style="list-style-type: none"> <li>• CRUD for L2 Bridge-Domain, interface assignment.</li> <li>• Create up to two bridge domains with all implemented functions turned on: flooding, unknown-unicast flooding, forwarding, learning, arp-termination.</li> <li>• Assign up to two physical interfaces to a single bridge domain.</li> <li>• Remove interface assignments, remove bridge domains.</li> <li>• Test case count: 5.</li> </ul>
L2FIB	<ul style="list-style-type: none"> <li>• CRD for L2-FIB entries.</li> <li>• Create 4 FIB entries: one of each for filter/forward, static/dynamic combinations.</li> <li>• Remove FIB entries</li> </ul>

Total 213 Honeycomb functional tests in the CSIT-1901.

Operational data in Honeycomb should mirror configuration data at all times. Because of this, test cases follow this general pattern:

1. read operational data of the feature using restconf.
2. read status of the feature using VPP API dump.
3. modify configuration of the feature using restconf.
4. verify changes to operational data using restconf.
5. verify changes using VPP API dump, OR
6. send a packet to VPP node and observe behaviour to verify configuration.

Test cases involving network interfaces utilize the first two interfaces on the DUT node.

### 6.1.3 Functional Tests Naming

CSIT-1901 follows a common structured naming convention for all performance and system functional tests, introduced in CSIT-17.01.

The naming should be intuitive for majority of the tests. Complete description of CSIT test naming convention is provided on *Test Naming* (page 864).

## 6.2 Release Notes

### 6.2.1 Changes in CSIT-1901

No changes.

### 6.2.2 Known Issues

Here is the list of known issues in CSIT-1901 for Honeycomb functional tests in VIRL:

#	JiraID	Issue Description
1	<a href="https://jira.fd.io/browse/HC2VPP-263">HC2VPP-263</a> <sup>194</sup>	LISP PITR feature configuration. Locator set reference in operational data is incorrect.
2	<a href="https://jira.fd.io/browse/CSIT-1210">CSIT-1210</a> <sup>195</sup>	Unnumbered interface configuration. VPP does not send IP addresses for unnumbered interfaces anymore. HC CSIT tests were relying on that.

## 6.3 Test Environment

FD.io CSIT HoneyComb functional tests are executed in the same FD.io virtual environment as used CSIT VPP functional tests. See description in [VPP Functional Tests Environment](#).

---

<sup>194</sup> <https://jira.fd.io/browse/HC2VPP-263>

<sup>195</sup> <https://jira.fd.io/browse/CSIT-1210>

## 6.4 Documentation

CSIT Honeycomb Functional Tests Documentation<sup>196</sup> contains detailed functional description and input parameters for each test case.

---

<sup>196</sup> <https://docs.fd.io/csit/rls1901/doc/tests.vpp.func.honeycomb.html>

## 7.1 Overview

### 7.1.1 Virtual Topologies

CSIT DMM functional tests are executed in VM-based virtual topologies created on demand using VIRL simulation platform contributed by Cisco. VIRL runs on physical baremetal servers hosted by LF FD.io project.

All tests are executed in three-node virtual test topology shown in the figure below.

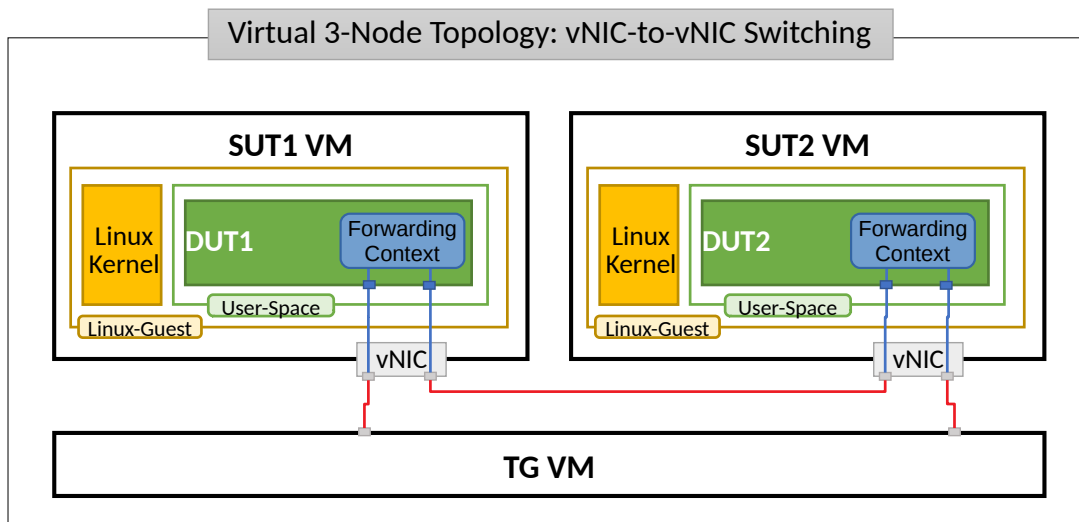

SUT1 and SUT2 are two VMs (running Ubuntu), TG is a Traffic Generator VM (running Ubuntu). SUTs run sample server-client application using the DMM libraries in Linux user- mode as a Device Under Test (DUT) within the VM. Currently TG node is not being used in DMM-CSIT. Network connectivity between SUTs and to TG is provided using virtual NICs and VMs' virtio drivers.

## 7.1.2 Functional Tests Coverage

CSIT-1901 includes following DMM functionality tested in virtual VM environment:

Functionality	Description
DMM basic operation	The test case demonstrates single server[DUT1] and single client[DUT2] scenario using DMM framework and kernel tcp/ip stack.
DMM lwip integration	

## 7.2 Release Notes

### 7.2.1 Changes in CSIT-1901

1. DMM FUNCTIONAL TESTS
  - Added DMM lwip integration test case.

### 7.2.2 Known Issues

Here is the list of known issues in CSIT-1901 for DMM functional tests in VIRL:

#	JiraID	Issue Description
1	<a href="#">DMM-17<sup>197</sup></a>	DMM CentOS job disabled. DPDK version and relative kernel version issue, CentOS job is temporarily disabled.

## 7.3 Test Environment

FD.io CSIT DMM functional tests are executed in the same FD.io VIRL virtual environment as used CSIT VPP functional tests. See description in [VPP Functional Tests Environment](#).

## 7.4 Documentation

[CSIT DMM Functional Tests Documentation<sup>198</sup>](#) contains detailed functional description and input parameters for each test case.

<sup>197</sup> <https://jira.fd.io/browse/DMM-17>

<sup>198</sup> <https://docs.fd.io/csit/rls1901/doc/tests.dmm.func.html>

### 8.1 Design

FD.io CSIT system design needs to meet continuously expanding requirements of FD.io projects including VPP, related sub-systems (e.g. plugin applications, DPDK drivers) and FD.io applications (e.g. DPDK applications), as well as growing number of compute platforms running those applications. With CSIT project scope and charter including both FD.io continuous testing AND performance trending/comparisons, those evolving requirements further amplify the need for CSIT framework modularity, flexibility and usability.

#### 8.1.1 Design Hierarchy

CSIT follows a hierarchical system design with SUTs and DUTs at the bottom level of the hierarchy, presentation level at the top level and a number of functional layers in-between. The current CSIT system design including CSIT framework is depicted in the figure below.

## CSIT System Design Hierarchy

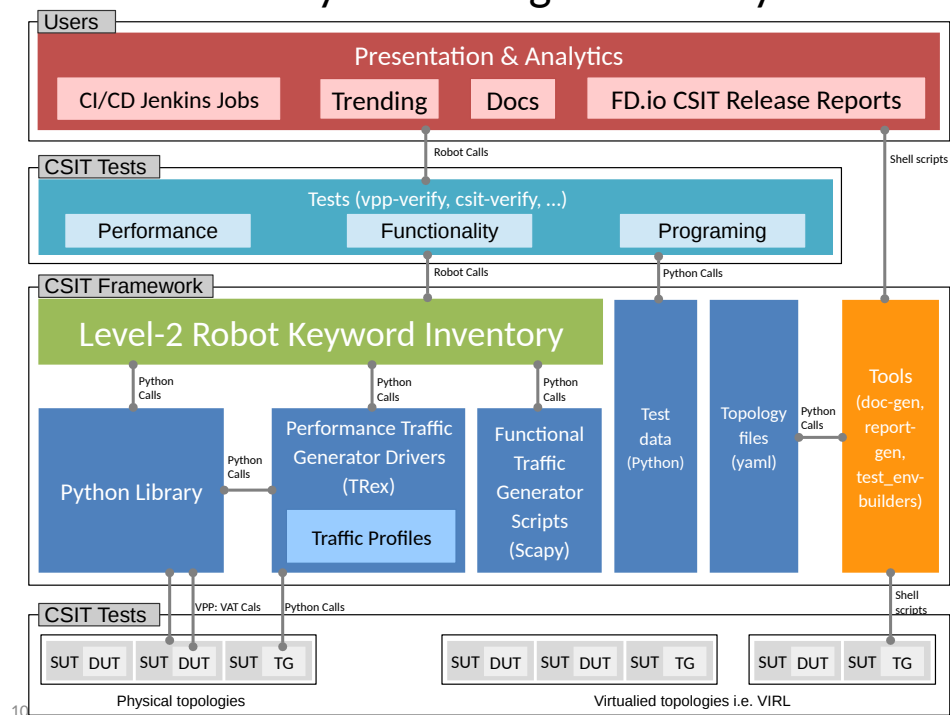

A brief bottom-up description is provided here:

### 1. SUTs, DUTs, TGs

- SUTs - Systems Under Test;
- DUTs - Devices Under Test;
- TGs - Traffic Generators;

### 2. Level-1 libraries - Robot and Python

- Lowest level CSIT libraries abstracting underlying test environment, SUT, DUT and TG specifics;
- Used commonly across multiple L2 KWs;
- Performance and functional tests:
  - L1 KWs (KeyWords) are implemented as RF libraries and Python libraries;
- Performance TG L1 KWs:
  - All L1 KWs are implemented as Python libraries:
    - \* Support for TRex only today;
    - \* CSIT IXIA drivers in progress;
- Performance data plane traffic profiles:
  - TG-specific stream profiles provide full control of:
    - \* Packet definition – layers, MACs, IPs, ports, combinations thereof e.g. IPs and UDP ports;
    - \* Stream definitions - different streams can run together, delayed, one after each other;
    - \* Stream profiles are independent of CSIT framework and can be used in any T-rex setup, can be sent anywhere to repeat tests with exactly the same setup;



- \* Easily extensible – one can create a new stream profile that meets tests requirements;
- \* Same stream profile can be used for different tests with the same traffic needs;
- Functional data plane traffic scripts:
  - Scapy specific traffic scripts;
- 3. Level-2 libraries - Robot resource files:
  - Higher level CSIT libraries abstracting required functions for executing tests;
  - L2 KWs are classified into the following functional categories:
    - Configuration, test, verification, state report;
    - Suite setup, suite teardown;
    - Test setup, test teardown;
- 4. Tests - Robot:
  - Test suites with test cases;
  - Functional tests using VIRT environment:
    - VPP;
    - Honeycomb;
    - NSH\_SFC;
  - Performance tests using physical testbed environment:
    - VPP;
    - DPDK-Testpmd;
    - DPDK-L3Fwd;
    - Honeycomb;
    - VPP Container K8s orchestrated topologies;
  - Tools:
    - Documentation generator;
    - Report generator;
    - Testbed environment setup ansible playbooks;
    - Operational debugging scripts;

### 8.1.2 Test Lifecycle Abstraction

A well coded test must follow a disciplined abstraction of the test lifecycles that includes setup, configuration, test and verification. In addition to improve test execution efficiency, the common aspects of test setup and configuration shared across multiple test cases should be done only once. Translating these high-level guidelines into the Robot Framework one arrives to definition of a well coded RF tests for FD.io CSIT. Anatomy of Good Tests for CSIT:

1. Suite Setup - Suite startup Configuration common to all Test Cases in suite: uses Configuration KWs, Verification KWs, StateReport KWs;
2. Test Setup - Test startup Configuration common to multiple Test Cases: uses Configuration KWs, StateReport KWs;
3. Test Case - uses L2 KWs with RF Gherkin style:
  - prefixed with {Given} - Verification of Test setup, reading state: uses Configuration KWs, Verification KWs, StateReport KWs;

- prefixed with {When} - Test execution: Configuration KWs, Test KWs;
  - prefixed with {Then} - Verification of Test execution, reading state: uses Verification KWs, StateReport KWs;
4. Test Teardown - post Test teardown with Configuration cleanup and Verification common to multiple Test Cases - uses: Configuration KWs, Verification KWs, StateReport KWs;
  5. Suite Teardown - Suite post-test Configuration cleanup: uses Configuration KWs, Verification KWs, StateReport KWs;

### 8.1.3 RF Keywords Functional Classification

CSIT RF KWs are classified into the functional categories matching the test lifecycle events described earlier. All CSIT RF L2 and L1 KWs have been grouped into the following functional categories:

1. Configuration;
2. Test;
3. Verification;
4. StateReport;
5. SuiteSetup;
6. TestSetup;
7. SuiteTeardown;
8. TestTeardown;

### 8.1.4 RF Keywords Naming Guidelines

Readability counts: “..code is read much more often than it is written.” Hence following a good and consistent grammar practice is important when writing RF KeyWords and Tests. All CSIT test cases are coded using Gherkin style and include only L2 KWs references. L2 KWs are coded using simple style and include L2 KWs, L1 KWs, and L1 python references. To improve readability, the proposal is to use the same grammar for both RF KW styles, and to formalize the grammar of English sentences used for naming the RF KWs. RF KWs names are short sentences expressing functional description of the command. They must follow English sentence grammar in one of the following forms:

1. **Imperative** - verb-object(s): “*Do something*”, verb in base form.
2. **Declarative** - subject-verb-object(s): “*Subject does something*”, verb in a third-person singular present tense form.
3. **Affirmative** - modal\_verb-verb-object(s): “*Subject should be something*”, “*Object should exist*”, verb in base form.
4. **Negative** - modal\_verb-Not-verb-object(s): “*Subject should not be something*”, “*Object should not exist*”, verb in base form.

Passive form MUST NOT be used. However a usage of past participle as an adjective is okay. See usage examples provided in the Coding guidelines section below. Following sections list applicability of the above grammar forms to different RF KW categories. Usage examples are provided, both good and bad.

### 8.1.5 Coding Guidelines

Coding guidelines can be found on [Design optimizations wiki page](#)<sup>199</sup>.

<sup>199</sup> [https://wiki.fd.io/view/CSIT/Design\\_Optimizations](https://wiki.fd.io/view/CSIT/Design_Optimizations)

## 8.2 Test Naming

### 8.2.1 Background

CSIT-1901 follows a common structured naming convention for all performance and system functional tests, introduced in CSIT-1701.

The naming should be intuitive for majority of the tests. Complete description of CSIT test naming convention is provided on [CSIT test naming wiki page](#)<sup>200</sup>. Below few illustrative examples of the naming usage for test suites across CSIT performance, functional and Honeycomb management test areas.

### 8.2.2 Naming Convention

The CSIT approach is to use tree naming convention and to encode following testing information into test suite and test case names:

1. packet network port configuration
  - port type, physical or virtual;
  - number of ports;
  - NIC model, if applicable;
  - port-NIC locality, if applicable;
2. packet encapsulations;
3. VPP packet processing
  - packet forwarding mode;
  - packet processing function(s);
4. packet forwarding path
  - if present, network functions (processes, containers, VMs) and their topology within the computer;
5. main measured variable, type of test.

Proposed convention is to encode ports and NICs on the left (underlay), followed by outer-most frame header, then other stacked headers up to the header processed by vSwitch-VPP, then VPP forwarding function, then encap on vhost interface, number of vhost interfaces, number of VMs. If chained VMs present, they get added on the right. Test topology is expected to be symmetric, in other words packets enter and leave SUT through ports specified on the left of the test name. Here some examples to illustrate the convention followed by the complete legend, and tables mapping the new test filenames to old ones.

### 8.2.3 Naming Examples

CSIT test suite naming examples (filename.robot) for common tested VPP topologies:

#### 1. Physical port to physical port - a.k.a. NIC-to-NIC, Phy-to-Phy, P2P

- *PortNICConfig-WireEncapsulation-PacketForwardingFunction- PacketProcessingFunction1-...-PacketProcessingFunctionN-TestType*
- *10ge2p1x520-dot1q-l2bdbasemaclrn-ndrdisc.robot* => 2 ports of 10GE on Intel x520 NIC, dot1q tagged Ethernet, L2 bridge-domain baseline switching with MAC learning, NDR throughput discovery.

---

<sup>200</sup> <https://wiki.fd.io/view/CSIT/csit-test-naming>

- *10ge2p1x520-ethip4vxlan-l2bdbasemaclrn-ndrchk.robot* => 2 ports of 10GE on Intel x520 NIC, IPv4 VXLAN Ethernet, L2 bridge-domain baseline switching with MAC learning, NDR throughput discovery.
- *10ge2p1x520-ethip4-ip4base-ndrdisc.robot* => 2 ports of 10GE on Intel x520 NIC, IPv4 baseline routed forwarding, NDR throughput discovery.
- *10ge2p1x520-ethip6-ip6scale200k-ndrdisc.robot* => 2 ports of 10GE on Intel x520 NIC, IPv6 scaled up routed forwarding, NDR throughput discovery.
- *10ge2p1x520-ethip4-ip4base-iacldstbase-ndrdisc.robot* => 2 ports of 10GE on Intel x520 NIC, IPv4 baseline routed forwarding, ingress Access Control Lists baseline matching on destination, NDR throughput discovery.
- *40ge2p1vic1385-ethip4-ip4base-ndrdisc.robot* => 2 ports of 40GE on Cisco vic1385 NIC, IPv4 baseline routed forwarding, NDR throughput discovery.
- *eth2p-ethip4-ip4base-func.robot* => 2 ports of Ethernet, IPv4 baseline routed forwarding, functional tests.

## 2. Physical port to VM (or VM chain) to physical port - a.k.a. NIC2VM2NIC, P2V2P, NIC2VMchain2NIC, P2V2V2P

- *PortNICConfig-WireEncapsulation-PacketForwardingFunction- PacketProcessingFunction1-...- PacketProcessingFunctionN-VirtEncapsulation- VirtPortConfig-VMconfig-TestType*
- *10ge2p1x520-dot1q-l2bdbasemaclrn-eth-2vhost-1vm-ndrdisc.robot* => 2 ports of 10GE on Intel x520 NIC, dot1q tagged Ethernet, L2 bridge-domain switching to/from two vhost interfaces and one VM, NDR throughput discovery.
- *10ge2p1x520-ethip4vxlan-l2bdbasemaclrn-eth-2vhost-1vm-ndrdisc.robot* => 2 ports of 10GE on Intel x520 NIC, IPv4 VXLAN Ethernet, L2 bridge-domain switching to/from two vhost interfaces and one VM, NDR throughput discovery.
- *10ge2p1x520-ethip4vxlan-l2bdbasemaclrn-eth-4vhost-2vm-ndrdisc.robot* => 2 ports of 10GE on Intel x520 NIC, IPv4 VXLAN Ethernet, L2 bridge-domain switching to/from four vhost interfaces and two VMs, NDR throughput discovery.
- *eth2p-ethip4vxlan-l2bdbasemaclrn-eth-2vhost-1vm-func.robot* => 2 ports of Ethernet, IPv4 VXLAN Ethernet, L2 bridge-domain switching to/from two vhost interfaces and one VM, functional tests.

## 3. API CRUD tests - Create (Write), Read (Retrieve), Update (Modify), Delete (Destroy) operations for configuration and operational data

- *ManagementTestKeyword-ManagementOperation-ManagedFunction1-...- ManagedFunctionN- ManagementAPI1-ManagementAPIN-TestType*
- *mgmt-cfg-lisp-apivat-func* => configuration of LISP with VAT API calls, functional tests.
- *mgmt-cfg-l2bd-aphc-apivat-func* => configuration of L2 Bridge-Domain with Honeycomb API and VAT API calls, functional tests.
- *mgmt-oper-int-aphcnc-func* => reading status and operational data of interface with Honeycomb NetConf API calls, functional tests.
- *mgmt-cfg-int-tap-aphcnc-func* => configuration of tap interfaces with Honeycomb NetConf API calls, functional tests.
- *mgmt-notif-int-subint-aphcnc-func* => notifications of interface and sub-interface events with Honeycomb NetConf Notifications, functional tests.

For complete description of CSIT test naming convention please refer to [CSIT test naming wiki page](#)<sup>201</sup>.

<sup>201</sup> <https://wiki.fd.io/view/CSIT/csit-test-naming>

## 8.3 Presentation and Analytics

### 8.3.1 Overview

The presentation and analytics layer (PAL) is the fourth layer of CSIT hierarchy. The model of presentation and analytics layer consists of four sub-layers, bottom up:

- sL1 - Data - input data to be processed:
  - Static content - .rst text files, .svg static figures, and other files stored in the CSIT git repository.
  - Data to process - .xml files generated by Jenkins jobs executing tests, stored as robot results files (output.xml).
  - Specification - .yaml file with the models of report elements (tables, plots, layout, ...) generated by this tool. There is also the configuration of the tool and the specification of input data (jobs and builds).
- sL2 - Data processing
  - The data are read from the specified input files (.xml) and stored as multi-indexed `pandas.Series`<sup>202</sup>.
  - This layer provides also interface to input data and filtering of the input data.
- sL3 - Data presentation - This layer generates the elements specified in the specification file:
  - Tables: .csv files linked to static .rst files.
  - Plots: .html files generated using plot.ly linked to static .rst files.
- sL4 - Report generation - Sphinx generates required formats and versions:
  - formats: html, pdf
  - versions: minimal, full (TODO: define the names and scope of versions)

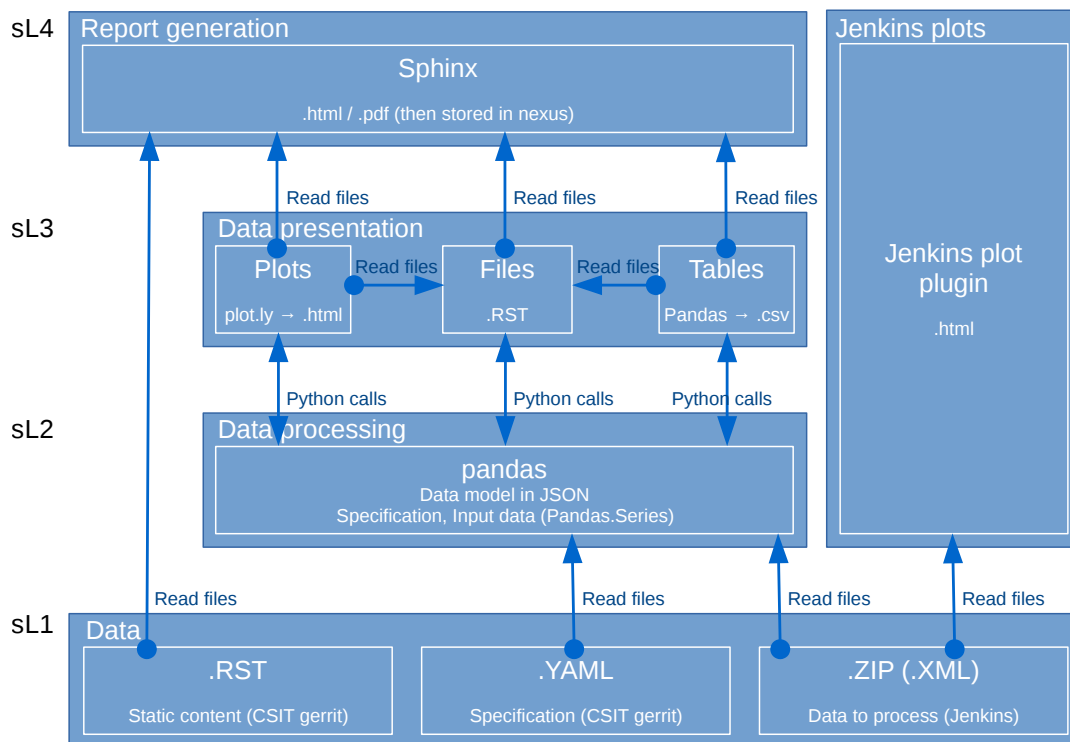

<sup>202</sup> <https://pandas.pydata.org/pandas-docs/stable/generated/pandas.Series.html>

## 8.3.2 Data

### Report Specification

The report specification file defines which data is used and which outputs are generated. It is human readable and structured. It is easy to add / remove / change items. The specification includes:

- Specification of the environment.
- Configuration of debug mode (optional).
- Specification of input data (jobs, builds, files, ...).
- Specification of the output.
- What and how is generated: - What: plots, tables. - How: specification of all properties and parameters.
- .yaml format.

### Structure of the specification file

The specification file is organized as a list of dictionaries distinguished by the type:

```

-
  type: "environment"
-
  type: "configuration"
-
  type: "debug"
-
  type: "static"
-
  type: "input"
-
  type: "output"
-
  type: "table"
-
  type: "plot"
-
  type: "file"

```

Each type represents a section. The sections "environment", "debug", "static", "input" and "output" are listed only once in the specification; "table", "file" and "plot" can be there multiple times.

Sections "debug", "table", "file" and "plot" are optional.

Table(s), files(s) and plot(s) are referred as "elements" in this text. It is possible to define and implement other elements if needed.

### Section: Environment

This section has the following parts:

- type: "environment" - says that this is the section "environment".
- configuration - configuration of the PAL.
- paths - paths used by the PAL.
- urls - urls pointing to the data sources.
- make-dirs - a list of the directories to be created by the PAL while preparing the environment.

- remove-dirs - a list of the directories to be removed while cleaning the environment.
- build-dirs - a list of the directories where the results are stored.

The structure of the section “Environment” is as follows (example):

```

-
type: "environment"
configuration:
  # Debug mode:
  # - Skip:
  #   - Download of input data files
  # - Do:
  #   - Read data from given zip / xml files
  #   - Set the configuration as it is done in normal mode
  # If the section "type: debug" is missing, CFG[DEBUG] is set to 0.
  CFG[DEBUG]: 0

paths:
  # Top level directories:
  ## Working directory
  DIR[WORKING]: "_tmp"
  ## Build directories
  DIR[BUILD,HTML]: "_build"
  DIR[BUILD,LATEX]: "_build_latex"

  # Static .rst files
  DIR[RST]: "../.../docs/report"

  # Working directories
  ## Input data files (.zip, .xml)
  DIR[WORKING,DATA]: "${DIR[WORKING]}/data"
  ## Static source files from git
  DIR[WORKING,SRC]: "${DIR[WORKING]}/src"
  DIR[WORKING,SRC,STATIC]: "${DIR[WORKING,SRC]}/_static"

  # Static html content
  DIR[STATIC]: "${DIR[BUILD,HTML]}/_static"
  DIR[STATIC,VPP]: "${DIR[STATIC]}/vpp"
  DIR[STATIC,DPDK]: "${DIR[STATIC]}/dpdk"
  DIR[STATIC,ARCH]: "${DIR[STATIC]}/archive"

  # Detailed test results
  DIR[DTR]: "${DIR[WORKING,SRC]}/detailed_test_results"
  DIR[DTR,PERF,DPDK]: "${DIR[DTR]}/dpdk_performance_results"
  DIR[DTR,PERF,VPP]: "${DIR[DTR]}/vpp_performance_results"
  DIR[DTR,PERF,HC]: "${DIR[DTR]}/honeycomb_performance_results"
  DIR[DTR,FUNC,VPP]: "${DIR[DTR]}/vpp_functional_results"
  DIR[DTR,FUNC,HC]: "${DIR[DTR]}/honeycomb_functional_results"
  DIR[DTR,FUNC,NSHSFC]: "${DIR[DTR]}/nshsfc_functional_results"
  DIR[DTR,PERF,VPP,IMPRV]: "${DIR[WORKING,SRC]}/vpp_performance_tests/performance_improvements"

  # Detailed test configurations
  DIR[DTC]: "${DIR[WORKING,SRC]}/test_configuration"
  DIR[DTC,PERF,VPP]: "${DIR[DTC]}/vpp_performance_configuration"
  DIR[DTC,FUNC,VPP]: "${DIR[DTC]}/vpp_functional_configuration"

  # Detailed tests operational data
  DIR[DTO]: "${DIR[WORKING,SRC]}/test_operational_data"
  DIR[DTO,PERF,VPP]: "${DIR[DTO]}/vpp_performance_operational_data"

  # .css patch file to fix tables generated by Sphinx
  DIR[CSS_PATCH_FILE]: "${DIR[STATIC]}/theme_overrides.css"

```

(continues on next page)

(continued from previous page)

```

DIR[CSS_PATCH_FILE2]: "${DIR[WORKING, SRC, STATIC]}/theme_overrides.css"

urls:
  URL[JENKINS,CSIT]: "https://jenkins.fd.io/view/csit/job"
  URL[JENKINS,HC]: "https://jenkins.fd.io/view/hc2vpp/job"

make-dirs:
  # List the directories which are created while preparing the environment.
  # All directories MUST be defined in "paths" section.
  - "DIR[WORKING, DATA]"
  - "DIR[STATIC, VPP]"
  - "DIR[STATIC, DPDK]"
  - "DIR[STATIC, ARCH]"
  - "DIR[BUILD, LATEX]"
  - "DIR[WORKING, SRC]"
  - "DIR[WORKING, SRC, STATIC]"

remove-dirs:
  # List the directories which are deleted while cleaning the environment.
  # All directories MUST be defined in "paths" section.
  #- "DIR[BUILD, HTML]"

build-dirs:
  # List the directories where the results (build) is stored.
  # All directories MUST be defined in "paths" section.
  - "DIR[BUILD, HTML]"
  - "DIR[BUILD, LATEX]"

```

It is possible to use defined items in the definition of other items, e.g.:

```
DIR[WORKING, DATA]: "${DIR[WORKING]}/data"
```

will be automatically changed to

```
DIR[WORKING, DATA]: "_tmp/data"
```

## Section: Configuration

This section specifies the groups of parameters which are repeatedly used in the elements defined later in the specification file. It has the following parts:

- data sets - Specification of data sets used later in element's specifications to define the input data.
- plot layouts - Specification of plot layouts used later in plots' specifications to define the plot layout.

The structure of the section "Configuration" is as follows (example):

```

-
  type: "configuration"
  data-sets:
    plot-vpp-throughput-latency:
      csit-vpp-perf-1710-all:
        - 11
        - 12
        - 13
        - 14
        - 15
        - 16
        - 17
        - 18

```

(continues on next page)



```

- 19
- 20
vpp-perf-results:
  csit-vpp-perf-1710-all:
    - 20
    - 23
plot-layouts:
  plot-throughput:
    xaxis:
      autorange: True
      autotick: False
      fixedrange: False
      gridcolor: "rgb(238, 238, 238)"
      linecolor: "rgb(238, 238, 238)"
      linewidth: 1
      showgrid: True
      showline: True
      showticklabels: True
      tickcolor: "rgb(238, 238, 238)"
      tickmode: "linear"
      title: "Indexed Test Cases"
      zeroline: False
    yaxis:
      gridcolor: "rgb(238, 238, 238)"
      hoverformat: ".4s"
      linecolor: "rgb(238, 238, 238)"
      linewidth: 1
      range: []
      showgrid: True
      showline: True
      showticklabels: True
      tickcolor: "rgb(238, 238, 238)"
      title: "Packets Per Second [pps]"
      zeroline: False
    boxmode: "group"
    boxgroupgap: 0.5
    autosize: False
    margin:
      t: 50
      b: 20
      l: 50
      r: 20
    showlegend: True
    legend:
      orientation: "h"
    width: 700
    height: 1000

```

The definitions from this sections are used in the elements, e.g.:

```

-
  type: "plot"
  title: "VPP Performance 64B-1t1c-(eth|dot1q|dot1ad)-(l2xcbase|l2bdbasemac|rn)-ndrdisc"
  algorithm: "plot_performance_box"
  output-file-type: ".html"
  output-file: "{DIR[STATIC,VPP]}/64B-1t1c-l2-se11-ndrdisc"
  data:
    "plot-vpp-throughput-latency"
  filter: "'64B' and ('BASE' or 'SCALE') and 'NDRDISC' and '1T1C' and ('L2BDMACSTAT' or 'L2BDMACLRN'
↪ or 'L2XCFWD') and not 'VHOST'"
  parameters:

```

(continues on next page)

(continued from previous page)

```

- "throughput"
- "parent"
traces:
  hoverinfo: "x+y"
  boxpoints: "outliers"
  whiskerwidth: 0
layout:
  title: "64B-1t1c-(eth|dot1q|dot1ad)-(l2xcbase|l2bdbasemaclrn)-ndrdisc"
  layout:
    "plot-throughput"

```

### Section: Debug mode

This section is optional as it configures the debug mode. It is used if one does not want to download input data files and use local files instead.

If the debug mode is configured, the "input" section is ignored.

This section has the following parts:

- type: "debug" - says that this is the section "debug".
- general:
  - input-format - xml or zip.
  - extract - if "zip" is defined as the input format, this file is extracted from the zip file, otherwise this parameter is ignored.
- builds - list of builds from which the data is used. Must include a job name as a key and then a list of builds and their output files.

The structure of the section "Debug" is as follows (example):

```

-
type: "debug"
general:
  input-format: "zip" # zip or xml
  extract: "robot-plugin/output.xml" # Only for zip
builds:
  # The files must be in the directory DIR[WORKING,DATA]
  csit-dpdk-perf-1707-all:
  -
    build: 10
    file: "csit-dpdk-perf-1707-all__10.xml"
  -
    build: 9
    file: "csit-dpdk-perf-1707-all__9.xml"
  csit-nsh_sfc-verify-func-1707-ubuntu1604-v1r1:
  -
    build: 2
    file: "csit-nsh_sfc-verify-func-1707-ubuntu1604-v1r1-2.xml"
  csit-vpp-functional-1707-ubuntu1604-v1r1:
  -
    build: lastSuccessfulBuild
    file: "csit-vpp-functional-1707-ubuntu1604-v1r1-lastSuccessfulBuild.xml"
  hc2vpp-csit-integration-1707-ubuntu1604:
  -
    build: lastSuccessfulBuild
    file: "hc2vpp-csit-integration-1707-ubuntu1604-lastSuccessfulBuild.xml"
  csit-vpp-perf-1707-all:
  -

```

(continues on next page)

(continued from previous page)

```

build: 16
file: "csit-vpp-perf-1707-all__16__output.xml"
-
build: 17
file: "csit-vpp-perf-1707-all__17__output.xml"

```

**Section: Static**

This section defines the static content which is stored in git and will be used as a source to generate the report.

This section has these parts:

- type: "static" - says that this section is the "static".
- src-path - path to the static content.
- dst-path - destination path where the static content is copied and then processed.

```

-
type: "static"
src-path: "{DIR[RST]}"
dst-path: "{DIR[WORKING, SRC]}"

```

**Section: Input**

This section defines the data used to generate elements. It is mandatory if the debug mode is not used.

This section has the following parts:

- type: "input" - says that this section is the "input".
- general - parameters common to all builds:
  - file-name: file to be downloaded.
  - file-format: format of the downloaded file, ".zip" or ".xml" are supported.
  - download-path: path to be added to url pointing to the file, e.g.: "{job}/{build}/robot/report/zip/{filename}"; {job}, {build} and {filename} are replaced by proper values defined in this section.
  - extract: file to be extracted from downloaded zip file, e.g.: "output.xml"; if xml file is downloaded, this parameter is ignored.
- builds - list of jobs (keys) and numbers of builds which output data will be downloaded.

The structure of the section "Input" is as follows (example from 17.07 report):

```

-
type: "input" # Ignored in debug mode
general:
  file-name: "robot-plugin.zip"
  file-format: ".zip"
  download-path: "{job}/{build}/robot/report/*zip*/{filename}"
  extract: "robot-plugin/output.xml"
builds:
  csit-vpp-perf-1707-all:
    - 9
    - 10
    - 13
    - 14

```

(continues on next page)

(continued from previous page)

```

- 15
- 16
- 17
- 18
- 19
- 21
- 22
csit-dpdk-perf-1707-all:
- 1
- 2
- 3
- 4
- 5
- 6
- 7
- 8
- 9
- 10
csit-vpp-functional-1707-ubuntu1604-vir1:
- lastSuccessfulBuild
hc2vpp-csit-perf-master-ubuntu1604:
- 8
- 9
hc2vpp-csit-integration-1707-ubuntu1604:
- lastSuccessfulBuild
csit-nsh_sfc-verify-func-1707-ubuntu1604-vir1:
- 2

```

### Section: Output

This section specifies which format(s) will be generated (html, pdf) and which versions will be generated for each format.

This section has the following parts:

- type: “output” - says that this section is the “output”.
- format: html or pdf.
- version: defined for each format separately.

The structure of the section “Output” is as follows (example):

```

-
  type: "output"
  format:
    html:
      - full
    pdf:
      - full
      - minimal

```

TODO: define the names of versions

### Content of “minimal” version

TODO: define the name and content of this version

## Section: Table

This section defines a table to be generated. There can be 0 or more “table” sections.

This section has the following parts:

- type: “table” - says that this section defines a table.
- title: Title of the table.
- algorithm: Algorithm which is used to generate the table. The other parameters in this section must provide all information needed by the used algorithm.
- template: (optional) a .csv file used as a template while generating the table.
- output-file-ext: extension of the output file.
- output-file: file which the table will be written to.
- columns: specification of table columns:
  - title: The title used in the table header.
  - data: Specification of the data, it has two parts - command and arguments:
    - \* command:
      - template - take the data from template, arguments:
        - number of column in the template.
      - data - take the data from the input data, arguments:
        - jobs and builds which data will be used.
      - operation - performs an operation with the data already in the table, arguments:
        - operation to be done, e.g.: mean, stdev, relative\_change (compute the relative change between two columns) and display number of data samples ~= number of test jobs. The operations are implemented in the utils.py TODO: Move from utils.py to e.g. operations.py
      - numbers of columns which data will be used (optional).
- data: Specify the jobs and builds which data is used to generate the table.
- filter: filter based on tags applied on the input data, if “template” is used, filtering is based on the template.
- parameters: Only these parameters will be put to the output data structure.

The structure of the section “Table” is as follows (example of “table\_performance\_improvements”):

```
-
type: "table"
title: "Performance improvements"
algorithm: "table_performance_improvements"
template: "{DIR[DTR,PERF,VPP,IMPRV]}/tpl_performance_improvements.csv"
output-file-ext: ".csv"
output-file: "{DIR[DTR,PERF,VPP,IMPRV]}/performance_improvements"
columns:
-
  title: "VPP Functionality"
  data: "template 1"
-
  title: "Test Name"
  data: "template 2"
-
  title: "VPP-16.09 mean [Mpps]"
```

(continues on next page)

(continued from previous page)

```

data: "template 3"
-
title: "VPP-17.01 mean [Mpps]"
data: "template 4"
-
title: "VPP-17.04 mean [Mpps]"
data: "template 5"
-
title: "VPP-17.07 mean [Mpps]"
data: "data csit-vpp-perf-1707-all mean"
-
title: "VPP-17.07 stdev [Mpps]"
data: "data csit-vpp-perf-1707-all stdev"
-
title: "17.04 to 17.07 change [%]"
data: "operation relative_change 5 4"
data:
  csit-vpp-perf-1707-all:
    - 9
    - 10
    - 13
    - 14
    - 15
    - 16
    - 17
    - 18
    - 19
    - 21
filter: "template"
parameters:
- "throughput"

```

Example of "table\_details" which generates "Detailed Test Results - VPP Performance Results":

```

-
type: "table"
title: "Detailed Test Results - VPP Performance Results"
algorithm: "table_details"
output-file-ext: ".csv"
output-file: "{DIR[WORKING]}/vpp_performance_results"
columns:
-
  title: "Name"
  data: "data test_name"
-
  title: "Documentation"
  data: "data test_documentation"
-
  title: "Status"
  data: "data test_msg"
data:
  csit-vpp-perf-1707-all:
    - 17
filter: "all"
parameters:
- "parent"
- "doc"
- "msg"

```

Example of "table\_details" which generates "Test configuration - VPP Performance Test Configs":

```
-
type: "table"
title: "Test configuration - VPP Performance Test Configs"
algorithm: "table_details"
output-file-ext: ".csv"
output-file: "{DIR[WORKING]}/vpp_test_configuration"
columns:
-
  title: "Name"
  data: "data name"
-
  title: "VPP API Test (VAT) Commands History - Commands Used Per Test Case"
  data: "data show-run"
data:
  csit-vpp-perf-1707-all:
    - 17
filter: "all"
parameters:
- "parent"
- "name"
- "show-run"
```

### Section: Plot

This section defines a plot to be generated. There can be 0 or more “plot” sections.

This section has these parts:

- type: “plot” - says that this section defines a plot.
- title: Plot title used in the logs. Title which is displayed is in the section “layout”.
- output-file-type: format of the output file.
- output-file: file which the plot will be written to.
- algorithm: Algorithm used to generate the plot. The other parameters in this section must provide all information needed by plot.ly to generate the plot. For example:
  - traces
  - layout
  - These parameters are transparently passed to plot.ly.
- data: Specify the jobs and numbers of builds which data is used to generate the plot.
- filter: filter applied on the input data.
- parameters: Only these parameters will be put to the output data structure.

The structure of the section “Plot” is as follows (example of a plot showing throughput in a chart box-with-whiskers):

```
-
type: "plot"
title: "VPP Performance 64B-1t1c-(eth|dot1q|dot1ad)-(l2xcbase|l2bdbasemaclrn)-ndrdisc"
algorithm: "plot_performance_box"
output-file-type: ".html"
output-file: "{DIR[STATIC,VPP]}/64B-1t1c-l2-se11-ndrdisc"
data:
  csit-vpp-perf-1707-all:
    - 9
    - 10
    - 13
```

(continues on next page)

(continued from previous page)

```

- 14
- 15
- 16
- 17
- 18
- 19
- 21
# Keep this formatting, the filter is enclosed with " (quotation mark) and
# each tag is enclosed with ' (apostrophe).
filter: "'64B' and 'BASE' and 'NDRDISC' and '1T1C' and ('L2BDMACSTAT' or 'L2BDMACLRN' or 'L2XCFWD
↵') and not 'VHOST'"
parameters:
- "throughput"
- "parent"
traces:
  hoverinfo: "x+y"
  boxpoints: "outliers"
  whiskerwidth: 0
layout:
  title: "64B-1t1c-(eth|dot1q|dot1ad)-(l2xcbase|l2bdbasemaclrn)-ndrdisc"
  xaxis:
    autorange: True
    autotick: False
    fixedrange: False
    gridcolor: "rgb(238, 238, 238)"
    linecolor: "rgb(238, 238, 238)"
    linewidth: 1
    showgrid: True
    showline: True
    showticklabels: True
    tickcolor: "rgb(238, 238, 238)"
    tickmode: "linear"
    title: "Indexed Test Cases"
    zeroline: False
  yaxis:
    gridcolor: "rgb(238, 238, 238)"
    hoverformat: ".4s"
    linecolor: "rgb(238, 238, 238)"
    linewidth: 1
    range: []
    showgrid: True
    showline: True
    showticklabels: True
    tickcolor: "rgb(238, 238, 238)"
    title: "Packets Per Second [pps]"
    zeroline: False
  boxmode: "group"
  boxgroupgap: 0.5
  autosize: False
  margin:
    t: 50
    b: 20
    l: 50
    r: 20
  showlegend: True
  legend:
    orientation: "h"
  width: 700
  height: 1000

```

The structure of the section "Plot" is as follows (example of a plot showing latency in a box chart):



```
-
type: "plot"
title: "VPP Latency 64B-1t1c-(eth|dot1q|dot1ad)-(l2xcbase|l2bdbasemaclrn)-ndrdisc"
algorithm: "plot_latency_box"
output-file-type: ".html"
output-file: "{DIR[STATIC,VPP]}/64B-1t1c-l2-sel1-ndrdisc-lat50"
data:
  csit-vpp-perf-1707-all:
    - 9
    - 10
    - 13
    - 14
    - 15
    - 16
    - 17
    - 18
    - 19
    - 21
  filter: "'64B' and 'BASE' and 'NDRDISC' and '1T1C' and ('L2BDMACSTAT' or 'L2BDMACLRN' or 'L2XCFWD
↪') and not 'VHOST'"
parameters:
  - "latency"
  - "parent"
traces:
  boxmean: False
layout:
  title: "64B-1t1c-(eth|dot1q|dot1ad)-(l2xcbase|l2bdbasemaclrn)-ndrdisc"
  xaxis:
    autorange: True
    autotick: False
    fixedrange: False
    gridcolor: "rgb(238, 238, 238)"
    linecolor: "rgb(238, 238, 238)"
    linewidth: 1
    showgrid: True
    showline: True
    showticklabels: True
    tickcolor: "rgb(238, 238, 238)"
    tickmode: "linear"
    title: "Indexed Test Cases"
    zeroline: False
  yaxis:
    gridcolor: "rgb(238, 238, 238)'"
    hoverformat: ""
    linecolor: "rgb(238, 238, 238)"
    linewidth: 1
    range: []
    showgrid: True
    showline: True
    showticklabels: True
    tickcolor: "rgb(238, 238, 238)"
    title: "Latency min/avg/max [uSec]"
    zeroline: False
  boxmode: "group"
  boxgroupgap: 0.5
  autosize: False
margin:
  t: 50
  b: 20
  l: 50
  r: 20
showlegend: True
```

(continues on next page)

(continued from previous page)

```

legend:
  orientation: "h"
  width: 700
  height: 1000

```

The structure of the section “Plot” is as follows (example of a plot showing VPP HTTP server performance in a box chart with pre-defined data “plot-vpp-http-server-performance” set and plot layout “plot-cps”):

```

-
type: "plot"
title: "VPP HTTP Server Performance"
algorithm: "plot_http_server_performance_box"
output-file-type: ".html"
output-file: "{DIR[STATIC,VPP]}/http-server-performance-cps"
data:
  "plot-vpp-http-server-performance"
# Keep this formatting, the filter is enclosed with " (quotation mark) and
# each tag is enclosed with ' (apostrophe).
filter: "'HTTP' and 'TCP_CPS'"
parameters:
- "result"
- "name"
traces:
  hoverinfo: "x+y"
  boxpoints: "outliers"
  whiskerwidth: 0
layout:
  title: "VPP HTTP Server Performance"
  layout:
    "plot-cps"

```

### Section: file

This section defines a file to be generated. There can be 0 or more “file” sections.

This section has the following parts:

- type: “file” - says that this section defines a file.
- title: Title of the table.
- algorithm: Algorithm which is used to generate the file. The other parameters in this section must provide all information needed by the used algorithm.
- output-file-ext: extension of the output file.
- output-file: file which the file will be written to.
- file-header: The header of the generated .rst file.
- dir-tables: The directory with the tables.
- data: Specify the jobs and builds which data is used to generate the table.
- filter: filter based on tags applied on the input data, if “all” is used, no filtering is done.
- parameters: Only these parameters will be put to the output data structure.
- chapters: the hierarchy of chapters in the generated file.
- start-level: the level of the the top-level chapter.

The structure of the section “file” is as follows (example):

```

-
type: "file"
title: "VPP Performance Results"
algorithm: "file_test_results"
output-file-ext: ".rst"
output-file: "{DIR[DTR,PERF,VPP]}/vpp_performance_results"
file-header: "\n.. |br| raw:: html\n\n <br />\n\n.. |prein| raw:: html\n\n <pre>\n\n\n..
↪|preout| raw:: html\n\n </pre>\n\n"
dir-tables: "{DIR[DTR,PERF,VPP]}"
data:
  csit-vpp-perf-1707-all:
    - 22
filter: "all"
parameters:
- "name"
- "doc"
- "level"
data-start-level: 2 # 0, 1, 2, ...
chapters-start-level: 2 # 0, 1, 2, ...

```

### Static content

- Manually created / edited files.
- .rst files, static .csv files, static pictures (.svg), ...
- Stored in CSIT git repository.

No more details about the static content in this document.

### Data to process

The PAL processes tests results and other information produced by Jenkins jobs. The data are now stored as robot results in Jenkins (TODO: store the data in nexus) either as .zip and / or .xml files.

### 8.3.3 Data processing

As the first step, the data are downloaded and stored locally (typically on a Jenkins slave). If .zip files are used, the given .xml files are extracted for further processing.

Parsing of the .xml files is performed by a class derived from “robot.api.ResultVisitor”, only necessary methods are overridden. All and only necessary data is extracted from .xml file and stored in a structured form.

The parsed data are stored as the multi-indexed pandas.Series data type. Its structure is as follows:

```

<job name>
  <build>
    <metadata>
    <suites>
    <tests>

```

“job name”, “build”, “metadata”, “suites”, “tests” are indexes to access the data. For example:

```

data =
job 1 name:
  build 1:
    metadata: metadata

```

(continues on next page)

(continued from previous page)

```

suites: suites
tests: tests
...
build N:
  metadata: metadata
  suites: suites
  tests: tests
...
job M name:
  build 1:
    metadata: metadata
    suites: suites
    tests: tests
    ...
  build N:
    metadata: metadata
    suites: suites
    tests: tests

```

Using indexes data["job 1 name"]["build 1"]["tests"] (e.g.: data["csit-vpp-perf-1704-all"]["17"]["tests"]) we get a list of all tests with all tests data.

Data will not be accessible directly using indexes, but using getters and filters.

#### Structure of metadata:

```

"metadata": {
  "version": "VPP version",
  "job": "Jenkins job name"
  "build": "Information about the build"
},

```

#### Structure of suites:

```

"suites": {
  "Suite name 1": {
    "doc": "Suite 1 documentation"
    "parent": "Suite 1 parent"
  }
  "Suite name N": {
    "doc": "Suite N documentation"
    "parent": "Suite N parent"
  }
}

```

#### Structure of tests:

##### Performance tests:

```

"tests": {
  "ID": {
    "name": "Test name",
    "parent": "Name of the parent of the test",
    "doc": "Test documentation"
    "msg": "Test message"
    "tags": ["tag 1", "tag 2", "tag n"],
    "type": "PDR" | "NDR",
    "throughput": {
      "value": int,
      "unit": "pps" | "bps" | "percentage"
    },
  },
  "latency": {
    "direction1": {

```

(continues on next page)

(continued from previous page)

```

    "100": {
      "min": int,
      "avg": int,
      "max": int
    },
    "50": { # Only for NDR
      "min": int,
      "avg": int,
      "max": int
    },
    "10": { # Only for NDR
      "min": int,
      "avg": int,
      "max": int
    }
  },
  "direction2": {
    "100": {
      "min": int,
      "avg": int,
      "max": int
    },
    "50": { # Only for NDR
      "min": int,
      "avg": int,
      "max": int
    },
    "10": { # Only for NDR
      "min": int,
      "avg": int,
      "max": int
    }
  }
},
"lossTolerance": "lossTolerance" # Only for PDR
"vat-history": "DUT1 and DUT2 VAT History"
},
"show-run": "Show Run"
},
"ID" {
  # next test
}

```

**Functional tests:**

```

"tests": {
  "ID": {
    "name": "Test name",
    "parent": "Name of the parent of the test",
    "doc": "Test documentation"
    "msg": "Test message"
    "tags": ["tag 1", "tag 2", "tag n"],
    "vat-history": "DUT1 and DUT2 VAT History"
    "show-run": "Show Run"
    "status": "PASS" | "FAIL"
  },
  "ID" {
    # next test
  }
}

```

Note: ID is the lowercase full path to the test.

## Data filtering

The first step when generating an element is getting the data needed to construct the element. The data are filtered from the processed input data.

The data filtering is based on:

- job name(s).
- build number(s).
- tag(s).
- required data - only this data is included in the output.

**WARNING:** The filtering is based on tags, so be careful with tagging.

For example, the element which specification includes:

```
data:
  csit-vpp-perf-1707-all:
    - 9
    - 10
    - 13
    - 14
    - 15
    - 16
    - 17
    - 18
    - 19
    - 21
filter:
  - "'64B' and 'BASE' and 'NDRDISC' and '1T1C' and ('L2BDMACSTAT' or 'L2BDMACLRN' or 'L2XCFWD') and_
↳not 'VHOST'"
```

will be constructed using data from the job “csit-vpp-perf-1707-all”, for all listed builds and the tests with the list of tags matching the filter conditions.

The output data structure for filtered test data is:

```
- job 1
  - build 1
    - test 1
      - parameter 1
      - parameter 2
      ...
      - parameter n
      ...
    - test n
    ...
  - build n
  ...
- job n
```

## Data analytics

Data analytics part implements:

- methods to compute statistical data from the filtered input data.
- trending.

## Throughput Speedup Analysis - Multi-Core with Multi-Threading

Throughput Speedup Analysis (TSA) calculates throughput speedup ratios for tested 1-, 2- and 4-core multi-threaded VPP configurations using the following formula:

$$N\_core\_throughput\_speedup = \frac{N\_core\_throughput}{1\_core\_throughput}$$

Multi-core throughput speedup ratios are plotted in grouped bar graphs for throughput tests with 64B/78B frame size, with number of cores on X-axis and speedup ratio on Y-axis.

For better comparison multiple test results' data sets are plotted per each graph:

- graph type: grouped bars;
- graph X-axis: (testcase index, number of cores);
- graph Y-axis: speedup factor.

Subset of existing performance tests is covered by TSA graphs.

### Model for TSA:

```
-
type: "plot"
title: "TSA: 64B-*- (eth|dot1q|dot1ad)-(l2xcbase|l2bdbasemaclrn)-ndrdisc"
algorithm: "plot_throughput_speedup_analysis"
output-file-type: ".html"
output-file: "${DIR[STATIC,VPP]}/10ge2p1x520-64B-l2-tsa-ndrdisc"
data:
  "plot-throughput-speedup-analysis"
filter: "'NIC_Intel-X520-DA2' and '64B' and 'BASE' and 'NDRDISC' and ('L2BDMACSTAT' or 'L2BDMACLRN
↳ or 'L2XCFWD') and not 'VHOST'"
parameters:
- "throughput"
- "parent"
- "tags"
layout:
  title: "64B-*- (eth|dot1q|dot1ad)-(l2xcbase|l2bdbasemaclrn)-ndrdisc"
  layout:
    "plot-throughput-speedup-analysis"
```

## Comparison of results from two sets of the same test executions

This algorithm enables comparison of results coming from two sets of the same test executions. It is used to quantify performance changes across all tests after test environment changes e.g. Operating System upgrades/patches, Hardware changes.

It is assumed that each set of test executions includes multiple runs of the same tests, 10 or more, to verify test results repeatability and to yield statistically meaningful results data.

Comparison results are presented in a table with a specified number of the best and the worst relative changes between the two sets. Following table columns are defined:

- name of the test;
- throughput mean values of the reference set;
- throughput standard deviation of the reference set;
- throughput mean values of the set to compare;
- throughput standard deviation of the set to compare;

- relative change of the mean values.

### The model

The model specifies:

- type: "table" - means this section defines a table.
- title: Title of the table.
- algorithm: Algorithm which is used to generate the table. The other parameters in this section must provide all information needed by the used algorithm.
- output-file-ext: Extension of the output file.
- output-file: File which the table will be written to.
- reference - the builds which are used as the reference for comparison.
- compare - the builds which are compared to the reference.
- data: Specify the sources, jobs and builds, providing data for generating the table.
- filter: Filter based on tags applied on the input data, if "template" is used, filtering is based on the template.
- parameters: Only these parameters will be put to the output data structure.
- nr-of-tests-shown: Number of the best and the worst tests presented in the table. Use 0 (zero) to present all tests.

Example:

```

-
type: "table"
title: "Performance comparison"
algorithm: "table_performance_comparison"
output-file-ext: ".csv"
output-file: "{DIR[DTR,PERF,VPP,IMPRV]}/vpp_performance_comparison"
reference:
  title: "csit-vpp-perf-1801-all - 1"
  data:
    csit-vpp-perf-1801-all:
      - 1
      - 2
compare:
  title: "csit-vpp-perf-1801-all - 2"
  data:
    csit-vpp-perf-1801-all:
      - 1
      - 2
data:
  "vpp-perf-comparison"
filter: "all"
parameters:
- "name"
- "parent"
- "throughput"
nr-of-tests-shown: 20

```

### Advanced data analytics

In the future advanced data analytics (ADA) will be added to analyze the telemetry data collected from SUT telemetry sources and correlate it to performance test results.

TODO



- describe the concept of ADA.
- add specification.

### 8.3.4 Data presentation

Generates the plots and tables according to the report models per specification file. The elements are generated using algorithms and data specified in their models.

#### Tables

- tables are generated by algorithms implemented in PAL, the model includes the algorithm and all necessary information.
- output format: csv
- generated tables are stored in specified directories and linked to .rst files.

#### Plots

- [plot.ly](https://plot.ly/)<sup>203</sup> is currently used to generate plots, the model includes the type of plot and all the necessary information to render it.
- output format: html.
- generated plots are stored in specified directories and linked to .rst files.

### 8.3.5 Report generation

Report is generated using Sphinx and Read\_the\_Docs template. PAL generates html and pdf formats. It is possible to define the content of the report by specifying the version (TODO: define the names and content of versions).

#### The process

1. Read the specification.
2. Read the input data.
3. Process the input data.
4. For element (plot, table, file) defined in specification:
  - (a) Get the data needed to construct the element using a filter.
  - (b) Generate the element.
  - (c) Store the element.
5. Generate the report.
6. Store the report (Nexus).

The process is model driven. The elements' models (tables, plots, files and report itself) are defined in the specification file. Script reads the elements' models from specification file and generates the elements.

It is easy to add elements to be generated in the report. If a new type of an element is required, only a new algorithm needs to be implemented and integrated.

---

<sup>203</sup> <https://plot.ly/>

### 8.3.6 Continuous Performance Measurements and Trending

#### Performance analysis and trending execution sequence:

CSIT PA runs performance analysis, change detection and trending using specified trend analysis metrics over the rolling window of last <N> sets of historical measurement data. PA is defined as follows:

1. PA job triggers:
  - (a) By PT job at its completion.
  - (b) Manually from Jenkins UI.
2. Download and parse archived historical data and the new data:
  - (a) New data from latest PT job is evaluated against the rolling window of <N> sets of historical data.
  - (b) Download RF output.xml files and compressed archived data.
  - (c) Parse out the data filtering test cases listed in PA specification (part of CSIT PAL specification file).
3. Calculate trend metrics for the rolling window of <N> sets of historical data:
  - (a) Calculate quartiles Q1, Q2, Q3.
  - (b) Trim outliers using IQR.
  - (c) Calculate TMA and TMSD.
  - (d) Calculate normal trending range per test case based on TMA and TMSD.
4. Evaluate new test data against trend metrics:
  - (a) If within the range of  $(TMA \pm 3 \cdot TMSD)$  => Result = Pass, Reason = Normal.
  - (b) If below the range => Result = Fail, Reason = Regression.
  - (c) If above the range => Result = Pass, Reason = Progression.
5. Generate and publish results
  - (a) Relay evaluation result to job result.
  - (b) Generate a new set of trend analysis summary graphs and drill-down graphs.
    - i. Summary graphs to include measured values with Normal, Progression and Regression markers. MM shown in the background if possible.
    - ii. Drill-down graphs to include MM, TMA and TMSD.
  - (c) Publish trend analysis graphs in html format on <https://docs.fd.io/csit/master/trending/>.

#### Parameters to specify:

*General section - parameters common to all plots:*

- type: "cpta";
- title: The title of this section;
- output-file-type: only ".html" is supported;
- output-file: path where the generated files will be stored.

*Plots section:*

- plot title;
- output file name;

- input data for plots;
  - job to be monitored - the Jenkins job which results are used as input data for this test;
  - builds used for trending plot(s) - specified by a list of build numbers or by a range of builds defined by the first and the last build number;
- tests to be displayed in the plot defined by a filter;
- list of parameters to extract from the data;
- plot layout

Example:

```

-
type: "cpta"
title: "Continuous Performance Trending and Analysis"
output-file-type: ".html"
output-file: "{DIR[STATIC,VPP]}/cpta"
plots:
  - title: "VPP 1T1C L2 64B Packet Throughput - Trending"
    output-file-name: "l2-1t1c-x520"
    data: "plot-performance-trending-vpp"
    filter: "'NIC_Intel-X520-DA2' and 'MRR' and '64B' and ('BASE' or 'SCALE') and '1T1C' and (
↪ 'L2BDMACSTAT' or 'L2BDMACLRN' or 'L2XC fwd') and not 'VHOST' and not 'MEMIF'"
    parameters:
      - "result"
    layout: "plot-cpta-vpp"
  - title: "DPDK 4T4C IMIX MRR Trending"
    output-file-name: "dppk-imix-4t4c-xl710"
    data: "plot-performance-trending-dppk"
    filter: "'NIC_Intel-XL710' and 'IMIX' and 'MRR' and '4T4C' and 'DPDK'"
    parameters:
      - "result"
    layout: "plot-cpta-dppk"

```

## The Dashboard

Performance dashboard tables provide the latest VPP throughput trend, trend compliance and detected anomalies, all on a per VPP test case basis. The Dashboard is generated as three tables for 1t1c, 2t2c and 4t4c MRR tests.

At first, the .csv tables are generated (only the table for 1t1c is shown):

```

-
type: "table"
title: "Performance trending dashboard"
algorithm: "table_performance_trending_dashboard"
output-file-ext: ".csv"
output-file: "{DIR[STATIC,VPP]}/performance-trending-dashboard-1t1c"
data: "plot-performance-trending-all"
filter: "'MRR' and '1T1C'"
parameters:
  - "name"
  - "parent"
  - "result"
ignore-list:
  - "tests.vpp.perf.l2.10ge2p1x520-eth-l2bdscale1mmaclrn-mrr.tc01-64b-1t1c-eth-l2bdscale1mmaclrn-
↪ ndrdisc"
outlier-const: 1.5

```

(continues on next page)

(continued from previous page)

```

window: 14
evaluated-window: 14
long-trend-window: 180

```

Then, html tables stored inside .rst files are generated:

```

-
type: "table"
title: "HTML performance trending dashboard 1t1c"
algorithm: "table_performance_trending_dashboard_html"
input-file: "{DIR[STATIC,VPP]}/performance-trending-dashboard-1t1c.csv"
output-file: "{DIR[STATIC,VPP]}/performance-trending-dashboard-1t1c.rst"

```

### 8.3.7 Root Cause Analysis

Root Cause Analysis (RCA) by analysing archived performance results – re-analyse available data for specified:

- range of jobs builds,
- set of specific tests and
- PASS/FAIL criteria to detect performance change.

In addition, PAL generates trending plots to show performance over the specified time interval.

#### Root Cause Analysis - Option 1: Analysing Archived VPP Results

It can be used to speed-up the process, or when the existing data is sufficient. In this case, PAL uses existing data saved in Nexus, searches for performance degradations and generates plots to show performance over the specified time interval for the selected tests.

#### Execution Sequence

1. Download and parse archived historical data and the new data.
2. Calculate trend metrics.
3. Find regression / progression.
4. Generate and publish results:
  - (a) Summary graphs to include measured values with Progression and Regression markers.
  - (b) List the DUT build(s) where the anomalies were detected.

#### CSIT PAL Specification

- What to test:
  - first build (Good); specified by the Jenkins job name and the build number
  - last build (Bad); specified by the Jenkins job name and the build number
  - step (1..n).
- Data:
  - tests of interest; list of tests (full name is used) which results are used

*Example:*

TODO

## 8.3.8 API

### List of modules, classes, methods and functions

specification\_parser.py

**class** Specification

Methods:

- read\_specification
- set\_input\_state
- set\_input\_file\_name

Getters:

- specification
- environment
- debug
- is\_debug
- input
- builds
- output
- tables
- plots
- files
- static

input\_data\_parser.py

**class** InputData

Methods:

- read\_data
- filter\_data

Getters:

- data
- metadata
- suites
- tests

environment.py

Functions:

- clean\_environment

**class** Environment

Methods:

- set\_environment

Getters:

- environment

input\_data\_files.py

(continues on next page)

(continued from previous page)

Functions:  
download\_data\_files  
unzip\_files

generator\_tables.py

Functions:  
generate\_tables

Functions implementing algorithms to generate particular types of tables (called by the function "generate\_tables"):

table\_details  
table\_performance\_improvements

generator\_plots.py

Functions:  
generate\_plots

Functions implementing algorithms to generate particular types of plots (called by the function "generate\_plots"):

plot\_performance\_box  
plot\_latency\_box

generator\_files.py

Functions:  
generate\_files

Functions implementing algorithms to generate particular types of files (called by the function "generate\_files"):

file\_test\_results

report.py

Functions:  
generate\_report

Functions implementing algorithms to generate particular types of report (called by the function "generate\_report"):

generate\_html\_report  
generate\_pdf\_report

Other functions called by the function "generate\_report":

archive\_input\_data  
archive\_report

**PAL functional diagram**

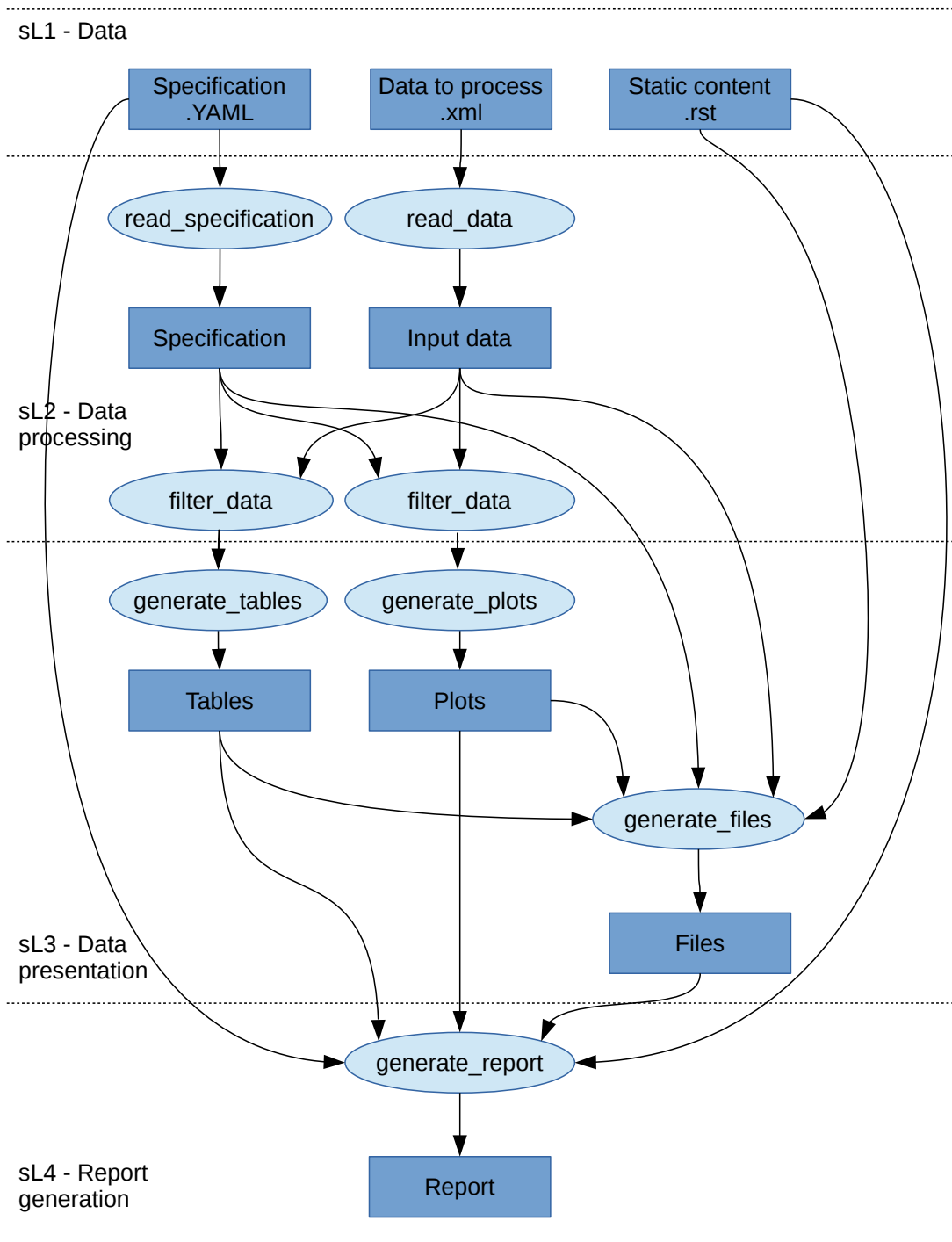

**How to add an element**

Element can be added by adding it's model to the specification file. If the element is to be generated by an existing algorithm, only it's parameters must be set.

If a brand new type of element needs to be added, also the algorithm must be implemented. Element generation algorithms are implemented in the files with names starting with "generator" prefix. The name of the function implementing the algorithm and the name of algorithm in the specification file have to be the same.

## 8.4 CSIT RF Tags Descriptions

All CSIT test cases are labelled with Robot Framework tags used to allow for easy test case type identification, test case grouping and selection for execution. Following sections list currently used CSIT TAGs and their documentation based on the content of [tag documentation rst file](#)<sup>204</sup>.

### 8.4.1 Testbed Topology Tags

#### 2\_NODE\_DOUBLE\_LINK\_TOPO

2 nodes connected in a circular topology with two links interconnecting the devices.

#### 2\_NODE\_SINGLE\_LINK\_TOPO

2 nodes connected in a circular topology with at least one link interconnecting devices.

#### 3\_NODE\_DOUBLE\_LINK\_TOPO

3 nodes connected in a circular topology with two links interconnecting the devices.

#### 3\_NODE\_SINGLE\_LINK\_TOPO

3 nodes connected in a circular topology with at least one link interconnecting devices.

### 8.4.2 Objective Tags

#### SKIP\_PATCH

Test case(s) marked to not run in case of vpp-csit-verify (i.e. VPP patch) and csit-vpp-verify jobs (i.e. CSIT patch).

#### SKIP\_VPP\_PATCH

Test case(s) marked to not run in case of vpp-csit-verify (i.e. VPP patch).

### 8.4.3 Environment Tags

#### HW\_ENV

DUTs and TGs are running on bare metal.

#### VM\_ENV

DUTs and TGs are running in virtual environment.

#### VPP\_VM\_ENV

DUTs with VPP and capable of running Virtual Machine.

---

<sup>204</sup> [https://git.fd.io/csit/tree/docs/tag\\_documentation.rst?h=rls1901](https://git.fd.io/csit/tree/docs/tag_documentation.rst?h=rls1901)



#### 8.4.4 NIC Model Tags

##### **NIC\_Intel-X520-DA2**

Intel X520-DA2 NIC.

##### **NIC\_Intel-XL710**

Intel XL710 NIC.

##### **NIC\_Intel-X710**

Intel X710 NIC.

##### **NIC\_Intel-XXV710**

Intel XXV710 NIC.

##### **NIC\_Cisco-VIC-1227**

VIC-1227 by Cisco.

##### **NIC\_Cisco-VIC-1385**

VIC-1385 by Cisco.

#### 8.4.5 Scaling Tags

##### **FIB\_20K**

2x10,000 entries in single fib table

##### **FIB\_200K**

2x100,000 entries in single fib table

##### **FIB\_2M**

2x1,000,000 entries in single fib table

##### **L2BD\_1**

Test with 1 L2 bridge domain.

##### **L2BD\_10**

Test with 10 L2 bridge domains.

##### **L2BD\_100**

Test with 100 L2 bridge domains.

**L2BD\_1K**

Test with 1000 L2 bridge domains.

**VLAN\_1**

Test with 1 VLAN sub-interface.

**VLAN\_10**

Test with 10 VLAN sub-interfaces.

**VLAN\_100**

Test with 100 VLAN sub-interfaces.

**VLAN\_1K**

Test with 1000 VLAN sub-interfaces.

**VXLAN\_1**

Test with 1 VXLAN tunnel.

**VXLAN\_10**

Test with 10 VXLAN tunnels.

**VXLAN\_100**

Test with 100 VXLAN tunnels.

**VXLAN\_1K**

Test with 1000 VXLAN tunnels.

**TNL\_1000**

IPSec in tunnel mode - 1000 tunnels.

**SRC\_USER\_10**

Traffic flow with 10 unique IPs (users) in one direction.

**SRC\_USER\_100**

Traffic flow with 100 unique IPs (users) in one direction.

**SRC\_USER\_1000**

Traffic flow with 1000 unique IPs (users) in one direction.

**SRC\_USER\_2000**

Traffic flow with 2000 unique IPs (users) in one direction.

#### **SRC\_USER\_4000**

Traffic flow with 4000 unique IPs (users) in one direction.

#### **100\_FLOWS**

Traffic stream with 100 unique flows (10 IPs/users x 10 UDP ports) in one direction.

#### **10k\_FLOWS**

Traffic stream with 10 000 unique flows (10 IPs/users x 1000 UDP ports) in one direction.

#### **100k\_FLOWS**

Traffic stream with 100 000 unique flows (100 IPs/users x 1000 UDP ports) in one direction.

### **8.4.6 Test Category Tags**

#### **FUNCTEST**

All functional test cases.

#### **PERFTEST**

All performance test cases.

### **8.4.7 Performance Type Tags**

#### **NDRPDR**

Single test finding both No Drop Rate and Partial Drop Rate simultaneously. The search is done by optimized algorithm which performs multiple trial runs at different durations and transmit rates. The results come from the final trials, which have duration of 30 seconds.

#### **MRR**

Performance tests where TG sends the traffic at maximum rate (line rate) and reports total sent/received packets over trial duration. The result is an average of 10 trials of 1 second duration.

#### **SOAK**

Performance tests using PLRsearch to find the critical load.

### **8.4.8 Ethernet Frame Size Tags**

#### **64B**

64B frames used for test.

#### **78B**

78B frames used for test.

**114B**

114B frames used for test.

**IMIX**

IMIX frame sequence (28x 64B, 16x 570B, 4x 1518B) used for test.

**1460B**

1460B frames used for test.

**1480B**

1480B frames used for test.

**1514B**

1514B frames used for test.

**1518B**

1518B frames used for test.

**9000B**

9000B frames used for test.

### 8.4.9 Test Type Tags

**BASE**

Baseline test cases, no encapsulation, no feature(s) configured in tests.

**IP4BASE**

IPv4 baseline test cases, no encapsulation, no feature(s) configured in tests.

**IP6BASE**

IPv6 baseline test cases, no encapsulation, no feature(s) configured in tests.

**L2XCBASE**

L2XC baseline test cases, no encapsulation, no feature(s) configured in tests.

**L2DBBASE**

L2BD baseline test cases, no encapsulation, no feature(s) configured in tests.

**L2PATCH**

L2PATCH baseline test cases, no encapsulation, no feature(s) configured in tests.

## SCALE

Scale test cases.

## ENCAP

Test cases where encapsulation is used. Use also encapsulation tag(s).

## FEATURE

At least one feature is configured in test cases. Use also feature tag(s).

## TLDK

Functional test cases for TLDK.

## DMM

Functional test cases for DMM.

## TCP

Tests which use TCP.

## TCP\_CPS

Performance tests which measure connections per second using http requests.

## TCP\_RPS

Performance tests which measure requests per second using http requests.

## HTTP

Tests which use HTTP.

## NF\_DENSITY

Performance tests that measure throughput of multiple VNF and CNF service topologies at different service densities.

### 8.4.10 NF Service Density Tags

#### CHAIN

NF service density tests with VNF or CNF service chain topology(ies).

#### PIPE

NF service density tests with CNF service pipeline topology(ies).

#### NF\_L3FWDIP4

NF service density tests with DPDK l3fwd IPv4 routing as NF workload.

**NF\_VPPIP4**

NF service density tests with VPP IPv4 routing as NF workload.

**{r}R{c}C**

Service density matrix locator {r}R{c}C, {r}Row denoting number of service instances, {c}Column denoting number of NFs per service instance. {r}=(1,2,4,6,8,10), {c}=(1,2,4,6,8,10).

**8.4.11 Forwarding Mode Tags****L2BDMACSTAT**

VPP L2 bridge-domain, L2 MAC static.

**L2BDMACLRN**

VPP L2 bridge-domain, L2 MAC learning.

**L2XCFWD**

VPP L2 point-to-point cross-connect.

**IP4FWD**

VPP IPv4 routed forwarding.

**IP6FWD**

VPP IPv6 routed forwarding.

**8.4.12 Underlay Tags****IP4UNRLAY**

IPv4 underlay.

**IP6UNRLAY**

IPv6 underlay.

**MPLSUNRLAY**

MPLS underlay.

**8.4.13 Overlay Tags****L2OVLAY**

L2 overlay.

#### **IP4OVLAY**

IPv4 overlay (IPv4 payload).

#### **IP6OVLAY**

IPv6 overlay (IPv6 payload).

### **8.4.14 Tagging Tags**

#### **DOT1Q**

All test cases with dot1q.

#### **DOT1AD**

All test cases with dot1ad.

### **8.4.15 Encapsulation Tags**

#### **ETH**

All test cases with base Ethernet (no encapsulation).

#### **LISP**

All test cases with LISP.

#### **LISPGPE**

All test cases with LISP-GPE.

#### **VXLAN**

All test cases with Vxlan.

#### **VXLANGPE**

All test cases with VXLAN-GPE.

#### **GRE**

All test cases with GRE.

#### **IPSEC**

All test cases with IPSEC.

#### **SRv6**

All test cases with Segment routing over IPv6 dataplane.

### 8.4.16 Interface Tags

#### **PHY**

All test cases which use physical interface(s).

#### **VHOST**

All test cases which uses VHOST.

#### **VHOST\_256**

All test cases which uses VHOST with qemu queue size set to 256.

#### **VHOST\_1024**

All test cases which uses VHOST with qemu queue size set to 1024.

#### **CFS\_OPT**

All test cases which uses VM with optimised scheduler policy.

#### **TUNTAP**

All test cases which uses TUN and TAP.

#### **AFPKT**

All test cases which uses AFPKT.

#### **NETMAP**

All test cases which uses Netmap.

#### **MEMIF**

All test cases which uses Memif.

#### **SINGLE\_MEMIF**

All test cases which uses only single Memif connection per DUT. One DUT instance is running in container having one physical interface exposed to container.

#### **LBOND**

All test cases which uses link bonding (BondEthernet interface).

#### **LBOND\_DPK**

All test cases which uses DPK link bonding.

#### **LBOND\_VPP**

All test cases which uses VPP link bonding.



#### **LBOND\_MODE\_XOR**

All test cases which uses link bonding with mode XOR.

#### **LBOND\_MODE\_LACP**

All test cases which uses link bonding with mode LACP.

#### **LBOND\_LB\_L34**

All test cases which uses link bonding with load-balance mode l34.

#### **LBOND\_1L**

All test cases which uses one link for link bonding.

#### **LBOND\_2L**

All test cases which uses two links for link bonding.

#### **DRV\_AVF**

All test cases which uses Intel Adaptive Virtual Function (AVF) device plugin for VPP. This plugins provides native device support for Intel AVF. AVF is driver specification for current and future Intel Virtual Function devices. In essence, today this driver can be used only with Intel XL710 / X710 / XXV710 adapters.

### **8.4.17 Feature Tags**

#### **IACLDST**

iACL destination.

#### **COPWHLIST**

COP whitelist.

#### **NAT44**

NAT44 configured and tested.

#### **NAT64**

NAT44 configured and tested.

#### **ACL**

ACL plugin configured and tested.

#### **IACL**

ACL plugin configured and tested on input path.

**OACL**

ACL plugin configured and tested on output path.

**ACL\_STATELESS**

ACL plugin configured and tested in stateless mode (permit action).

**ACL\_STATEFUL**

ACL plugin configured and tested in stateful mode (permit+reflect action).

**ACL1**

ACL plugin configured and tested with 1 not-hitting ACE.

**ACL10**

ACL plugin configured and tested with 10 not-hitting ACEs.

**ACL50**

ACL plugin configured and tested with 50 not-hitting ACEs.

**SRv6\_PROXY**

SRv6 endpoint to SR-unaware appliance via proxy.

**SRv6\_PROXY\_STAT**

SRv6 endpoint to SR-unaware appliance via static proxy.

**SRv6\_PROXY\_DYN**

SRv6 endpoint to SR-unaware appliance via dynamic proxy.

**SRv6\_PROXY\_MASQ**

SRv6 endpoint to SR-unaware appliance via masquerading proxy.

**8.4.18 Encryption Tags****IPSECSW**

Crypto in software.

**IPSECHW**

Crypto in hardware.

**IPSECTRAN**

IPSec in transport mode.

## **IPSECTUN**

IPSec in tunnel mode.

### **8.4.19 Client-Workload Tags**

#### **VM**

All test cases which use at least one virtual machine.

#### **LXC**

All test cases which use Linux container and LXC utils.

#### **DRC**

All test cases which use at least one Docker container.

#### **DOCKER**

All test cases which use Docker as container manager.

#### **APP**

All test cases with specific APP use.

### **8.4.20 Container Orchestration Tags**

#### **K8S**

All test cases which use Kubernetes for orchestration.

#### **SFC\_CONTROLLER**

All test cases which use ligato/sfc\_controller for driving configuration of vpp inside container.

#### **VPP\_AGENT**

All test cases which use Golang implementation of a control/management plane for VPP

#### **1VSWITCH**

VPP running in Docker container acting as VSWITCH.

#### **1VNF**

1 VPP running in Docker container acting as VNF work load.

#### **2VNF**

2 VPP running in 2 Docker containers acting as VNF work load.

## 4VNF

4 VPP running in 4 Docker containers acting as VNF work load.

### 8.4.21 Multi-Threading Tags

#### STHREAD

*Dynamic tag.* All test cases using single poll mode thread.

#### MTHREAD

*Dynamic tag.* All test cases using more than one poll mode driver thread.

#### 1NUMA

All test cases with packet processing on single socket.

#### 2NUMA

All test cases with packet processing on two sockets.

#### 1C

1 worker thread pinned to 1 dedicated physical core; or if HyperThreading is enabled, 2 worker threads each pinned to a separate logical core within 1 dedicated physical core. Main thread pinned to core 1.

#### 2C

2 worker threads pinned to 2 dedicated physical cores; or if HyperThreading is enabled, 4 worker threads each pinned to a separate logical core within 2 dedicated physical cores. Main thread pinned to core 1.

#### 4C

4 worker threads pinned to 4 dedicated physical cores; or if HyperThreading is enabled, 8 worker threads each pinned to a separate logical core within 4 dedicated physical cores. Main thread pinned to core 1.

#### 1T1C

*Dynamic tag.* 1 worker thread pinned to 1 dedicated physical core. 1 receive queue per interface. Main thread pinned to core 1.

#### 2T2C

*Dynamic tag.* 2 worker threads pinned to 2 dedicated physical cores. 1 receive queue per interface. Main thread pinned to core 1.

#### 4T4C

*Dynamic tag.* 4 worker threads pinned to 4 dedicated physical cores. 2 receive queues per interface. Main thread pinned to core 1.

#### 2T1C

**Dynamic tag.** 2 worker threads each pinned to a separate logical core within 1 dedicated physical core. 1 receive queue per interface. Main thread pinned to core 1.

#### 4T2C

**Dynamic tag.** 4 worker threads each pinned to a separate logical core within 2 dedicated physical cores. 2 receive queues per interface. Main thread pinned to core 1.

#### 8T4C

**Dynamic tag.** 8 worker threads each pinned to a separate logical core within 4 dedicated physical cores. 4 receive queues per interface. Main thread pinned to core 1.

### 8.4.22 Honeycomb Tags

#### HC\_FUNC

Honeycomb functional test cases.

#### HC\_NSH

Honeycomb NSH test cases.

#### HC\_PERSIST

Honeycomb persistence test cases.

#### HC\_REST\_ONLY

(Exclusion tag) Honeycomb test cases that cannot be run in Netconf mode using ODL client for Restfconf -> Netconf translation.

- [lxc] [Linux Containers](#)<sup>111</sup>
- [lxcnamespace] [Resource management: Linux kernel Namespaces and cgroups](#)<sup>112</sup>.
- [stgraber] [LXC 1.0: Blog post series](#)<sup>113</sup>.
- [lxcsecurity] [Linux Containers Security](#)<sup>114</sup>.
- [capabilities] [Linux manual - capabilities - overview of Linux capabilities](#)<sup>115</sup>.
- [cgroup1] [Linux kernel documentation: cgroups](#)<sup>116</sup>.
- [cgroup2] [Linux kernel documentation: Control Group v2](#)<sup>117</sup>.
- [selinux] [SELinux Project Wiki](#)<sup>118</sup>.
- [lxcsecfeatures] [LXC 1.0: Security features](#)<sup>119</sup>.
- [lxcsource] [Linux Containers source](#)<sup>120</sup>.
- [apparmor] [Ubuntu AppArmor](#)<sup>121</sup>.
- [seccomp] [SECure COMPUting with filters](#)<sup>122</sup>.
- [docker] [Docker](#)<sup>123</sup>.
- [k8sdoc] [Kubernetes documentation](#)<sup>124</sup>.
- [ligato] [Ligato](#)<sup>125</sup>.
- [govpp] [FD.io goVPP project](#)<sup>126</sup>.
- [vppagent] [Ligato vpp-agent](#)<sup>127</sup>.

---

<sup>111</sup> <https://linuxcontainers.org/>

<sup>112</sup> <https://www.cs.ucsb.edu/~rich/class/cs293b-cloud/papers/lxc-namespace.pdf>

<sup>113</sup> <https://stgraber.org/2013/12/20/lxc-1-0-blog-post-series/>

<sup>114</sup> <https://linuxcontainers.org/lxc/security/>

<sup>115</sup> <http://man7.org/linux/man-pages/man7/capabilities.7.html>

<sup>116</sup> <https://www.kernel.org/doc/Documentation/cgroup-v1/cgroups.txt>

<sup>117</sup> <https://www.kernel.org/doc/Documentation/cgroup-v2.txt>

<sup>118</sup> [http://selinuxproject.org/page/Main\\_Page](http://selinuxproject.org/page/Main_Page)

<sup>119</sup> <https://stgraber.org/2014/01/01/lxc-1-0-security-features/>

<sup>120</sup> <https://github.com/lxc/lxc>

<sup>121</sup> <https://wiki.ubuntu.com/AppArmor>

<sup>122</sup> [https://www.kernel.org/doc/Documentation/prctl/seccomp\\_filter.txt](https://www.kernel.org/doc/Documentation/prctl/seccomp_filter.txt)

<sup>123</sup> <https://www.docker.com/what-docker>

<sup>124</sup> <https://kubernetes.io/docs/home/>

<sup>125</sup> <https://github.com/ligato>

<sup>126</sup> <https://wiki.fd.io/view/GoVPP>

<sup>127</sup> <https://github.com/ligato/vpp-agent>

[imagevar] Image parameter is required in initial commit version. There is plan to implement container build class to build Docker/LXC image.

[TWSLink] [TWS](#)<sup>163</sup>

[dockerhub] [Docker hub](#)<sup>164</sup>

[fdiocsitgerrit] [FD.io/CSIT gerrit](#)<sup>165</sup>

[fdioregistry] [FD.io registry](#)

[JenkinsSlaveDcrFile] [jenkins-slave-dcr-file](#)<sup>166</sup>

[CsitShimDcrFile] [csit-shim-dcr-file](#)<sup>167</sup>

[CsitSutDcrFile] [csit-sut-dcr-file](#)<sup>168</sup>

[ansiblelink] [ansible](#)<sup>169</sup>

[fdiocsitansible] [Fd.io/CSIT ansible](#)<sup>170</sup>

[inteli40e] [Intel i40e](#)<sup>171</sup>

[pciids] [pci ids](#)<sup>172</sup>

---

<sup>163</sup> <https://wiki.fd.io/view/CSIT/TWS>

<sup>164</sup> <https://hub.docker.com/>

<sup>165</sup> <https://gerrit.fd.io/r/CSIT>

<sup>166</sup> <https://github.com/snergfdio/multivppcache/blob/master/ubuntu18/Dockerfile>

<sup>167</sup> <https://github.com/snergfdio/multivppcache/blob/master/csit-shim/Dockerfile>

<sup>168</sup> <https://github.com/snergfdio/multivppcache/blob/master/csit-sut/Dockerfile>

<sup>169</sup> <https://www.ansible.com/>

<sup>170</sup> <https://git.fd.io/csit/tree/resources/tools/testbed-setup/ansible>

<sup>171</sup> <https://downloadmirror.intel.com/26370/eng/readme.txt>

<sup>172</sup> <http://pci-ids.ucw.cz/v2.2/pci.ids>